



**SELF-ADHESIVE TECHNOLOGY**

Self-adhesive waterproofing membranes



*Adds value!*

# CONTENTS

1. Introduction	page <b>3</b>
2. Polyglass SpA	page <b>5</b>
3. Self-adhesive membranes	page <b>6</b>
4. <b>ADESO</b> ® self-adhesive membranes	page <b>7</b>
5. Complementary products	page <b>11</b>
6. Preparing to install <b>ADESO</b> ®	page <b>14</b>
7. Installing an <b>ADESO</b> ® system	page <b>16</b>
8. Suitable applications for <b>ADESO</b> ®	page <b>21</b>
9. Installation of construction details	page <b>49</b>
Addendum - Finishing elements and details: technical drawings	<b>I-XXIV</b>





## 2. POLYGLASS SPA

Polyglass SpA is one of the major European companies producing a wide range of waterproof products designed for the commercial and industrial sector in particular:

- polymer distilled bitumen membranes
- TPO/FPO and PVC-P synthetic membranes
- pre-bonded thermal insulation systems
- special products

Polyglass SpA was the first Italian manufacturer to venture into the international polymer distilled bitumen membrane market, with its products and technologies present in over 40 countries.

Polyglass SpA's manufacturing facility is in Ponte di Piave in the province of Treviso, which is also home to company headquarters. The company operates also through the subsidiary Polyglass USA Inc. in North America, with 5 production facilities and in the UK through the subsidiary Polyglass GB Ltd.

Polyglass SpA is part of the MAPEI Group, one of the international leaders in construction chemistry, consisting of 81 subsidiaries, of which there are 9 service companies, 18 main R&D centres, 1 of which corporate, and 70 production facilities operating in 32 countries in the five continents, each boasting a quality control laboratory.

Polyglass waterproofing systems are distributed and applied successfully all over the world, exposed to a whole range of different and critical environmental and operating conditions.

Polyglass SpA has been an ISO 9001-certified company since 1995 and ISO 14001-certified since 2010, and is a member of the Green Building Council Italia.



All Polyglass products can help earn credits for the LEED certification of buildings.

### 3. SELF-ADHESIVE MEMBRANES

Waterproofing systems, manufactured with polymer distilled bitumen membranes have, traditionally, either been applied using a propane gas torch or using bituminous adhesives.

However, waterproofing systems have evolved and this advancement has been achieved by utilising enhanced production techniques, producing membranes with improved technical performance with the use of new polymers to modify the mass of distilled bitumen.

During the mid-'90s, Polyglass started producing self-adhesive membranes to meet new design requirements characterised by the presence of non-flame-resistant insulation and construction materials. The self-adhesive membrane technology is also the product of technological progress in line with the greater attention towards respecting the environment and safety on site. The use of the **ADESO**<sup>®</sup> range fully complies with these requirements by creating no fumes, noise or danger in general associated with traditional installation techniques.

This type of membrane is produced by layering and diffusing the bitumen compound along the production line; the self-adhesive side of the membrane is made with a new-generation innovative compound made with distilled bitumen, specifically selected and modified with elastomeric polymers.

This formulation guarantees an optimal balance between radial and linear elastomeric polymers (SBS), promoting more homogeneous bitumen dispersion within the polymers or copolymers, achieving increased adhesion, improved durability over time and a considerable increase in cold flexibility values.

The self-adhesive membranes of the **ADESO**<sup>®</sup> line are used on various types of roofs: flat, sloping and curved, and increasingly where timber roof construction prevents the use of traditional methods of installation.

Application without the use of naked flames guarantees consistent quality of the bituminous compound over the lifetime of the product and ensures that work carried out is completely safe using skilled and specialised installers.

Polyglass SpA has produced self-adhesive membranes for over 30 years and the considerable experience gathered during these years in both the European market and North America, thanks to Polyglass USA with four production facilities, makes Polyglass the world leader in both this sector and in the world wide waterproofing market.

## 4. **ADESO**® SELF ADHESIVE MEMBRANES

The **ADESO**® line of products includes a series of self-adhesive membranes where the upper face of the reinforcing carrier is made with a bituminous elastoplastomeric (APP) or elastomeric (SBS) compound, while the underside, consists of a highly adhesive bituminous compound.

The self-adhesive underside of **ADESO**® products are protected by a mono-silicone polyethylene film, divided into two equal parts along the length of the roll, to make its removal easier while laying the roll. On the black side, in contact with the self-adhesive compound, the mono-silicone protective film is treated with special non-stick silicone, while the visible grey side has no such treatment.

The upper surface of **ADESO**® products are produced with various surface finishes, depending on their intended use (see **ADESO**® range and Intended uses pg 8):

- protective release film in mono-silicone polyethylene
- protective film in high density polyethylene (HDPE)
- mineral granules
- polyester/polypropylene fabric
- sand

On products with a mineral granule surface, the lateral and end-lap selvages are protected by a non-stick mono-silicone polyethylene film, to be removed during installation (FASTLap), additionally the lateral selvages have multiple polyurethane adhesive lines (SEALLap) which act as a glue, even with temperatures of +10 °C. In versions where the surface finish is polyester fabric or polyethylene film, only the side lateral selvage is present.

The main strengths and advantages of the **ADESO**® range of products are:

- application without the use of naked flames
- suitable for use on heat-sensitive insulation panels
- ease and speed of application and installation
- convenient and quick application even on vertical and retaining walls
- excellent final appearance
- environmentally friendly
- health and safety advantages

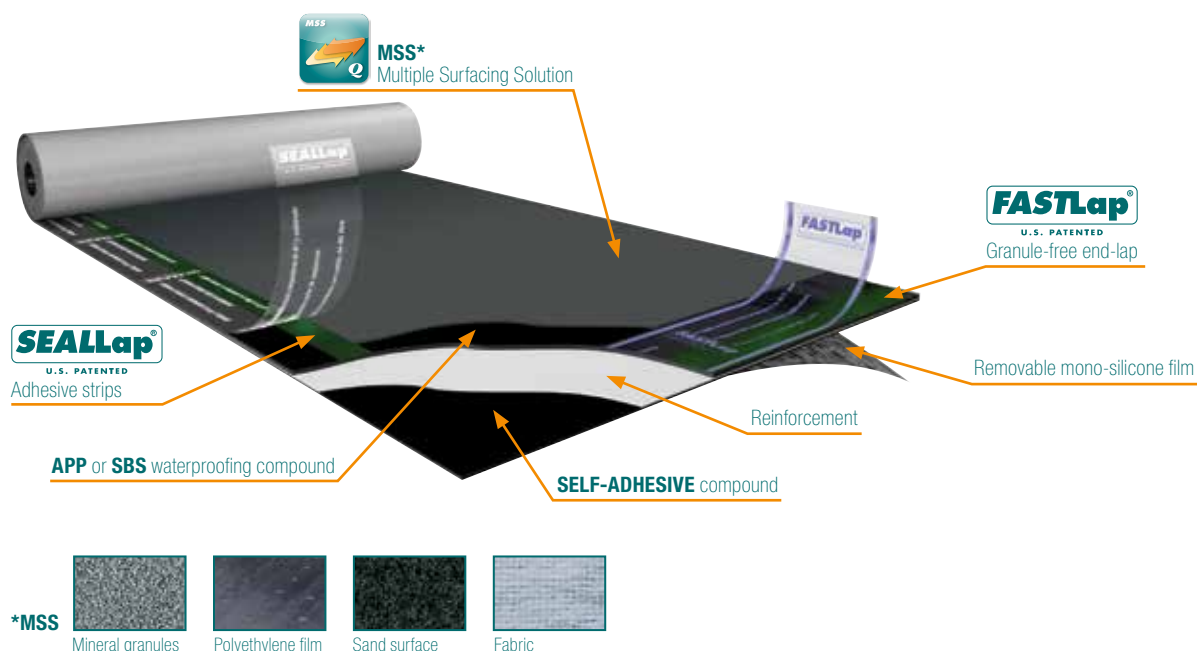

## ADESO® RANGE AND INTENDED USES

PRODUCTS		INTENDED USE					
NAME	THICKNESS / WEIGHT	MULTI-PLY EXPOSED COVER		VAPOUR BARRIER	FOUNDATIONS		UNDERLAYERS
		SECOND LAYER	FIRST LAYER		RISING DAMP	GROUNDWATER	
ELASTOFLEX SA P	2 mm		•		•		
ELASTOFLEX SA P Mineral	3,5 kg	•					•
SPIDER P	2 mm		•		•		
SPIDER P	3 mm		•		•		
SPIDER P Mineral	3,5 kg	•					•
SPIDER P Mineral	4 kg	•					•
POLYVAP SA	2 mm			•			
ADESOSHIELD SA	2 mm			•			
POLYSTICK TU PLUS	2 mm						•
ADESOGUARD	1,8 mm				•		

Certain **ADESO®** membranes can also be used as a torch receivable layer on a substrate or insulation board sensitive to flames (EPS or XPS boards). Where installing waterproofing systems under walkways or green roofs, etc. please ensure that the surface finish is suitable for its intended use.

## ADESO® RANGE SELF-ADHESIVE MEMBRANES

### ELASTOFLEX SA P - ELASTOFLEX SA P MINERAL



This is a prefabricated bitumen membrane made with an elastomeric compound (BPE/SBS) that has a polyester staple-fibre non-woven carrier reinforced and stabilized with glass strands parallel to the machine direction. Flexibility at low temperature -20 °C.

ELASTOFLEX SA P and ELASTOFLEX SA P MINERAL are used as part of a complete flat roof waterproofing system with the mineral granules version used as a final layer. They comply with the EN 13707 standard.

ELASTOFLEX SA P MINERAL (mineral granules finishes) is used as tile underlay and complies with the EN 13859-1 standard.

ELASTOFLEX SA P is used as foundation covering (rising damp or percolating water) and complies with the EN 13969 TYPE T standard.

### ELASTOFLEX SA P AF - ELASTOFLEX SA P AF MINERAL



This is a prefabricated bitumen membrane made with an elastomeric compound (BPE/SBS) that has a polyester staple-fibre non-woven carrier reinforced and stabilized with glass strands parallel to the machine direction. Flexibility at low temperature -20 °C.

ELASTOFLEX SA P AF and ELASTOFLEX SA P AF MINERAL are certified as resistant to external fire in class B<sub>ROOF</sub> (t2) according to ENV 1187 and EN 13501-5, for applications on timber decks with a density  $\geq 460$  kg/m<sup>3</sup> and any slope. ELASTOFLEX SA P AF and ELASTOFLEX SA P AF MINERAL are used as final layers and comply with the EN 13707 standard.



### SPIDER P - SPIDER P MINERAL



This is a self-adhesive prefabricated bitumen membrane made with an elastoplastomeric compound (BPP/APP) that has a polyester staple-fibre non-woven carrier reinforced and stabilized with glass strands parallel to the machine direction. Flexibility at low temperature -10 °C.

SPIDER P and SPIDER P MINERAL are used as part of a complete flat roof waterproofing system with the mineral granules version used as a final layer. They comply with the EN 13707 standard.

SPIDER P is used as foundation covering (rising damp or percolating water) and complies with the EN 13969 TYPE T standard.

### POLYVAP SA



This is a prefabricated double-sided self-adhesive bitumen membrane made with an elastomeric compound (BPE/SBS) and reinforced with an aluminium film. POLYVAP SA is protected on both sides with a mono-silicone coated polyethylene backing film to be peeled off as the membrane is laid. Flexibility at low temperature -25 °C. POLYVAP SA is used as a vapour barrier and complies with the EN 13970 standard.

### ADESOSHIELD SA



This is a double-sided self-adhesive prefabricated bitumen membrane made with an elastomeric compound (BPE/SBS) that has a polyester staple-fibre non-woven carrier reinforced and stabilized with glass strands parallel to the machine direction. Flexibility at low temperature -25 °C.

ADESOSHIELD SA is used as a vapour barrier and complies with the EN 13970 standard.

### POLYSTICK TU PLUS



This is a self-adhesive prefabricated bitumen membrane made with an elastoplastomeric compound (BPP/APP) with reinforced fibre glass mat carrier and laminated, on the facing, with a polyester non-woven carrier. Suitable to be applied under POLYTEGOLA N and POLYTEGOLA PLUS.

Flexibility at low temperature -10 °C.

POLYSTICK TU PLUS is used as tile underlay and complies with the EN 13859-1 standard.

## ADESOGUARD



This is a self-adhesive prefabricated bitumen membrane made with an elastomeric compound (SBS) with reinforced fibre glass mat carrier and, on the facing, a cross-laminated polyethylene high density film (HDPE). ADESOGUARD is designed specifically to be used in foundations when waterproofing retaining walls (rising damp and percolating water) or as an underfloor moisture barrier and complies with the EN 13969 TYPE T standard.

## 5. COMPLEMENTARY PRODUCTS

A waterproofing system does not consist only of **ADESO**® self-adhesive membranes, in fact, to achieve a complete, long-lasting and functional build-up, complementary products and/or accessories are essential. POLYGLASS provides a range of complementary products, suitable to various types of surfaces and construction details, capable of meeting various technical requirements, for industrial, civil and commercial works.

### IDROPRIMER



IDROPRIMER is a water-based bituminous primer used to prime concrete or timber surfaces, reducing porosity and eliminating dust, allowing bitumen polymer membranes to be installed quickly. Its use is recommended in habitable buildings. IDROPRIMER is non-flammable and non-hazardous. Do not apply on cold, damp days or when it is raining as this can impede drying.

### POLYPRIMER HP 45 PROFESSIONAL



POLYPRIMER HP 45 PROFESSIONAL is a bituminous primer made with blown bitumen and fast-drying solvents, and can be used outdoors, and on non-inhabited areas. POLYPRIMER HP 45 PROFESSIONAL is used as a primer for concrete surfaces, reducing porosity and eliminating dust, allowing self-adhesive bitumen polymer membranes to be installed and applied quickly.

### ADESINT PRIMER



ADESINT PRIMER is a solvent based synthetic primer with high adhesion properties. Based on synthetic resins it is used on concrete roof decks and prefabricated concrete structures. ADESINT PRIMER allows bitumen polymer membranes, and in particular, self-adhesive bitumen polymer membranes to be installed and applied quickly.

### POLYSINT SUN REFLECT



POLYSINT SUN REFLECT is a white water-based fibre-reinforced liquid membrane formulated with special synthetic resins, offering high solar reflectivity (83%) and thermal emissivity (91%) ratings, with a solar reflectance index (SRI) of 105. POLYSINT SUN REFLECT is applied as a high solar reflectivity protective layer on **ADESO**® membranes with a mineral slate finish.

### POLYVER SUPER WHITE



POLYVER SUPER WHITE is a solvent-based white paint for the protection of polymer bitumen membranes, formulated with special synthetic resins, extenders, pigments, fungicides, anti-algae agents and various additives, offering high solar reflectivity (84%) and thermal emissivity (88%) ratings, with a solar reflectance index (SRI) of 106.

POLYVER SUPER WHITE is applied as a high solar reflectivity protective layer on **ADESO**® membranes with a mineral slate finish.

### MINERAL FIX



MINERAL FIX is a milky white water-based sealing paint that dries to a clear finish.

MINERAL FIX is used to protect and preserve the mineral slate surface finish on **ADESO**® membranes.

### POLYDETAIL MS



POLYDETAIL MS is a one-pack MS Polymer sealant, designed for sealing, repairing and installing technical features.

It can also be used to seal bitumen membranes at the junction of vertical up-turns between a metal profile (finishing flashing) and a vertical wall.

### POLYTAPE PE FOAM



Sealing tape in expanded polyethylene foam with a closed cell structure to seal tile underlay membranes at the fixing points of battens on sloping roofs, self-adhesive on one side to adhere to the timber baton.

### POLYGLUE PU 2K



POLYGLUE PU 2K is a solvent-free and fast-drying two-component polyurethane adhesive to glue insulating panels. It is supplied in biaxial cartridges (double container with just one spout/mixer already supplied). It is applied with a special battery gun.

### POLYFOND KIT DRAIN



POLYFOND KIT DRAIN is an embossed membrane made from high-density extruded polyethylene (HDPE) with white polypropylene needle-punched non-woven fabric that guarantees excellent rain draining capability. POLYFOND KIT DRAIN is ideal for applications with the dual purpose of protecting the waterproofing membrane and providing it with drainage in retaining walls during foundation backfilling work.

### SILVERTEK 15 SEAL LAP / SILVERTEK 25 SEAL LAP



SILVERTEK 15 SEAL LAP, for applications with > 30% slope, and SILVERTEK 25 SEAL LAP, for applications with < 30% slope, are highly breathable underlays, compliant with the standard. They are prefabricated with a double adhesive band, offering excellent performance when used as a waterproof layer under tiles, and as an airtight/windproof layer for pitched ventilated roof systems.

The product consists of two layers of spunbond polypropylene UV-stabilized non-woven fabric, with a highly breathable microporous polypropylene film in-between.

A 50 mm-high BUTYLSTRIP can be used to seal the ends. For sealing and connecting to any details (roof edge, chimney, guttering and roof windows), we recommend using 200 mm-high BUTYLSTRIP.

SILVERTEK 15 SEAL LAP is ideal for pitched roofs with a ventilation chamber to cover and protect the thermal insulation layer.

### VENTS AND OUTLETS



**ADESO**® accessories also include: normal and super outlets, 90° corner outlets, corner outlets with round/square fitting, single or double polyethylene vents and adjustable leaf guards.

## 6. PREPARING TO INSTALL **ADESO**<sup>®</sup>

### 6.1 SITE SUPPLY AND STORAGE REGULATIONS

**ADESO**<sup>®</sup> membranes must always be stored indoors, in a dry area, away from direct sunlight and protected from adverse weather conditions, on wooden pallets raised from the ground, until required. Stacking two or more pallets is not recommended, since the inside of the rolls might be crushed, deformed or stick together, making the membrane unusable.

We advise that the job site be supplied only with the necessary material required at any one time; if this is not possible and the material must be stored on site, in addition to the above instructions, we recommend that you carefully make some side cuts in the shrink-wrapped polyethylene covering the pallets, in order to release any residual heat or vapour.

Never leave the membranes in a horizontal position as the membrane may become deformed or stick together and become unusable. Keep the membrane always in its original packaging (cardboard box) even if it is a partial roll (from Figure 6.1 to 6.4).

Hoisting membranes must be carried out with the utmost care and in compliance with all relevant workplace health and safety regulations; Hoisting loose rolls with ropes may damage the product and/or cause accidental damage to people or property.

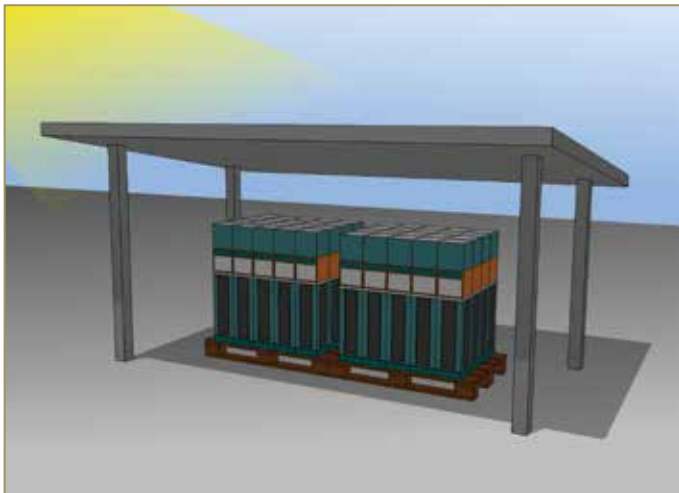

Figure 6.1: Store the products far from direct sunlight or extreme weather conditions



Figure 6.2: Avoid stacking two or more pallets

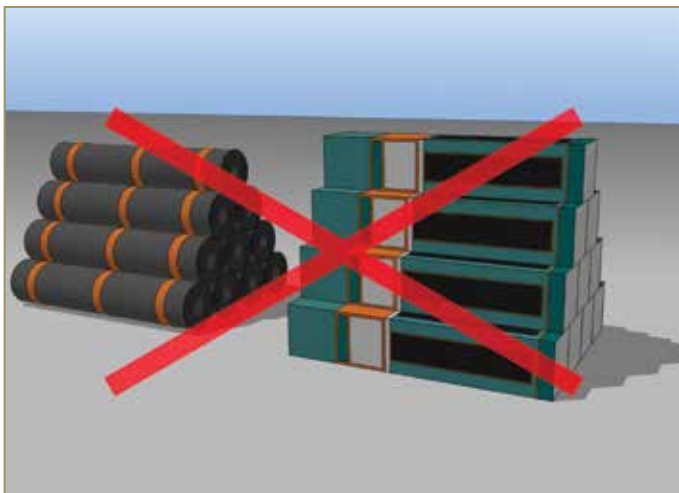

Figure 6.3: Do not leave or store the rolls of membrane in a horizontal position

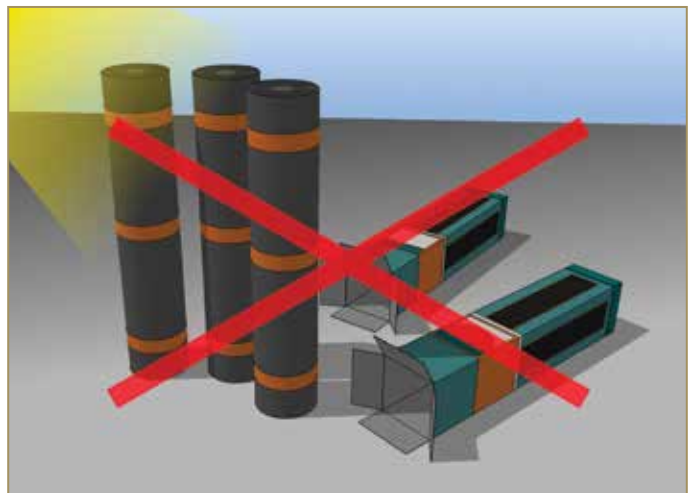
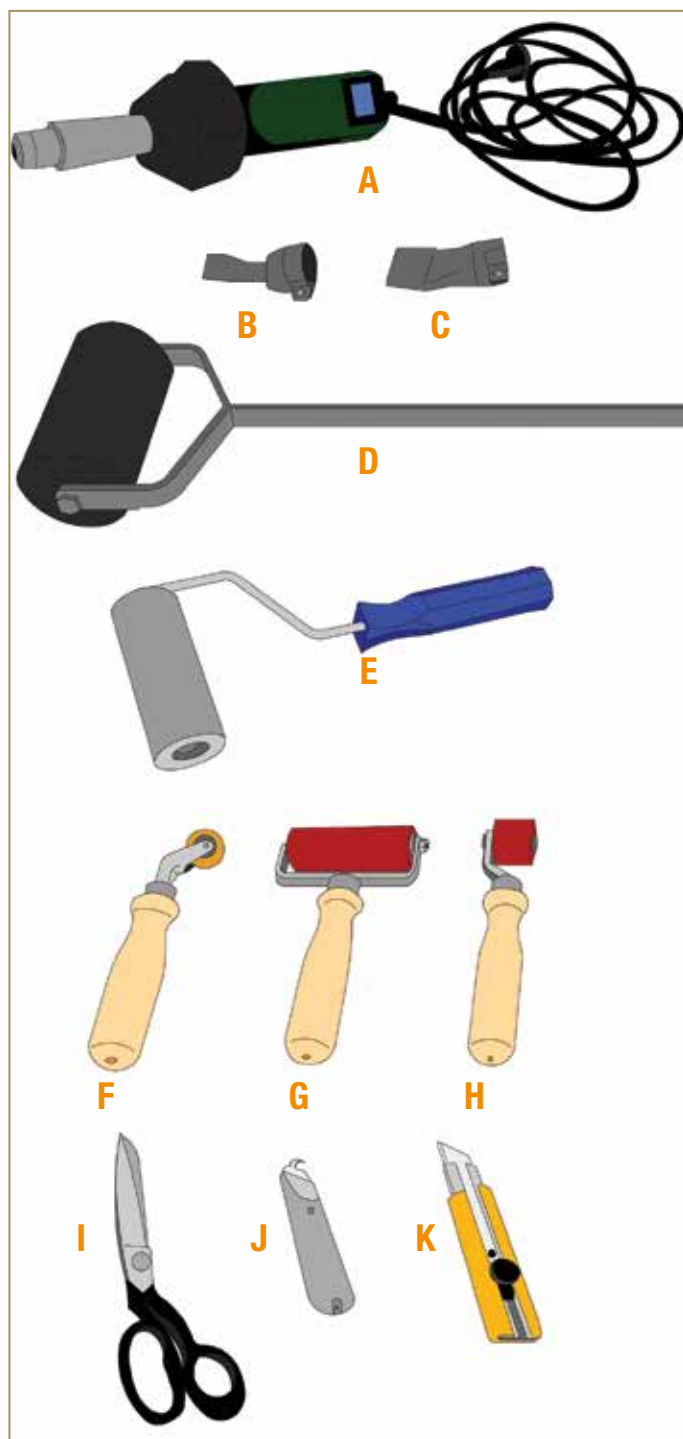

Figure 6.4: Always keep the membrane rolls in their original packaging (cardboard box)

## 6.2 INSTALLATION EQUIPMENT

The equipment required to install the self-adhesive membranes is as follows:

- Stiff bristle brush to clean surfaces.
- Suitable rollers to apply the bitumen primer.
- Leister-type, hot air welder for the installation of technical details and related accessories.
- Useful cutting tools such as hook or straight blade cutters, long blade cutters to cut the insulating elements and scissors.
- Membrane measuring tools such as tape measures and/or metric measuring bands.
- Rolling tools such as silicone and brass pressing roller, to complete all details, a metal roller to install the vertical components and a metal roller to press the bitumen membrane overlaps.



- A - Triac AT Leister-type hot air welding tool
- B - 20mm nozzle
- C - 40mm nozzle
- D - Metal roller 8kg metal roller
- E - Metal roller for vertical elements
- F - Brass roller
- G - Rubber roller
- H - Rubber roller
- I - Scissors
- J - Hook blade cutter
- K - Flat blade cutter

### NOTE

**We also remind you that, apart from the above tools, PPE (Personal Protective Equipment) is mandatory to install ADESO® membranes, as required by local regulations.**

## 7. INSTALLING AN **ADESO**<sup>®</sup> SYSTEM

### 7.1 CHECKING AND PREPARING THE SURFACE

Waterproofing must be carried out on dry and clean surfaces, free from rough sections and dust. Avoid laying the membranes in adverse weather conditions such as imminent rain, high humidity, temperatures lower than +10 °C or on wet cement surfaces. During the summer, we recommend that polymer distilled bitumen products should not to be applied during extreme temperatures (+35 °C). As well making handling and installation more difficult, working in excessive heat, may result in damage to any previously installed membrane by footmarks .

Before installing **ADESO**<sup>®</sup> membranes, a suitable solvent or water-based bitumen primer should be applied to the surface. A water-based primer is recommended for timber substrates (Figure 7.1).

For vertical concrete walls, where a release agent or antifreeze products have been used in the concrete mix, we recommend that, before applying the primer and membrane, the walls are pressure-washed and application tests are carried out, to ensure that the membrane will satisfactorily adhered to the surface.



Figure 7.1: Application of the primer

### 7.2 THERMO-HYGROMETRIC CHECK AND LAYING THE VAPOUR CONTROL LAYER

To apply the membranes in thermally insulated roofs, a thermo-hygrometric check (Glaser diagram) should be carried out by an expert technician, in order to quantify the various layers and possible triggering of liminal or interstitial condensation within the layers themselves. The thermo-hygrometric check can reveal the need to insert a membrane to act as a "Vapour Barrier" under the insulation layer, in compliance with EN 13970.

There are two types of **ADESO**<sup>®</sup> membranes designed as vapour barriers, offering different resistance values to water vapour  $\mu$  (EN 1931):

- POLYVAP SA 2 mm             $\mu = 700.000$
- ADESOSHIELD SA 2 mm     $\mu = 95.000$

Both are double sided self-adhesive membranes that can be applied without the use of flames or propane torches.

Prior to installation, the membranes should be completely unrolled in their final position, half of the released mono-silicone film on the bottom surface should then be removed allowing one half to be adhered, before then removing the second half of the release film, paying attention that air bubbles or folds are avoided, then continue adhering the remaining part of the membrane. Proceed to install adjacent sheets, to obtain an area fully protected by the vapour barrier.

In sites where the work cannot be completed in a working day, and to avoid any accidental penetrations that might affect the integrity of the of the vapour barrier, we recommend only applying sufficient vapour barrier on a surface area that can be covered by an insulating layer followed by the first waterproofing layer.

The product must be installed in temperatures of  $\geq +10$  °C and with optimal weather



### 7.3 LAYING THERMAL INSULATION

The thermal insulation layer should be clean and free from dust and be suitably resistant to compression.

The types of insulating panels used with **ADESO**® self-adhesive membranes are:

- Insulating panel in polystyrene foam EPS  $\geq 100$  kPa (Figure 7.2)
- Insulating panel in extruded polystyrene foam XPS with skin  $\geq 300$  kPa (Figure 7.3)
- PUR/PIR insulating panel between two embossed aluminium surfaces  $\geq 120$  kPa (Figure 7.4)
- PUR/PIR insulating panel between two multi-layer aluminium surfaces  $\geq 120$  kPa (Figure 7.5)
- PUR/PIR insulating panel between two saturated fibre glass mat surfaces  $\geq 120$  kPa (Figure 7.6)



Figure 7.2: EPS insulating panel



Figure 7.3: XPS insulating panel

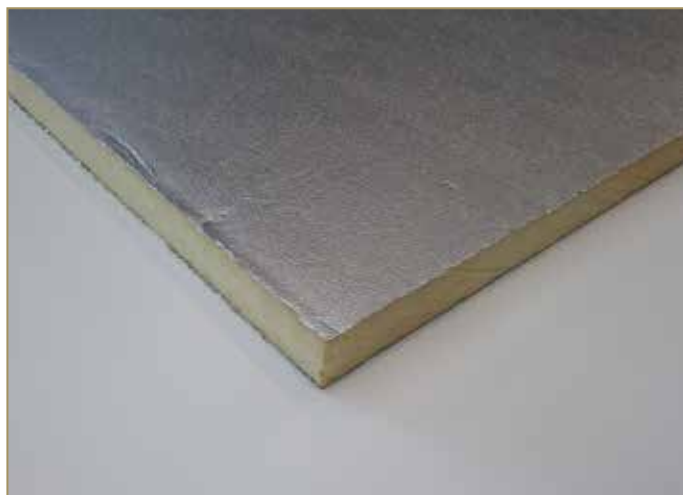

Figure 7.4: PUR/PIR insulating panel + embossed aluminium

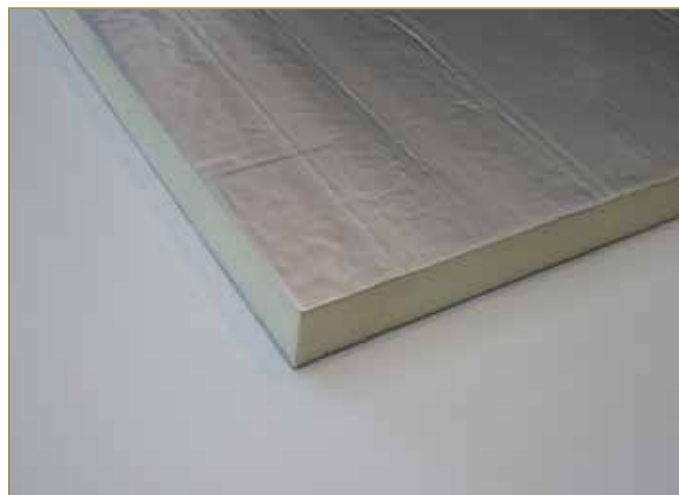

Figure 7.5: PUR/PIR insulating panel + multi-layer aluminium



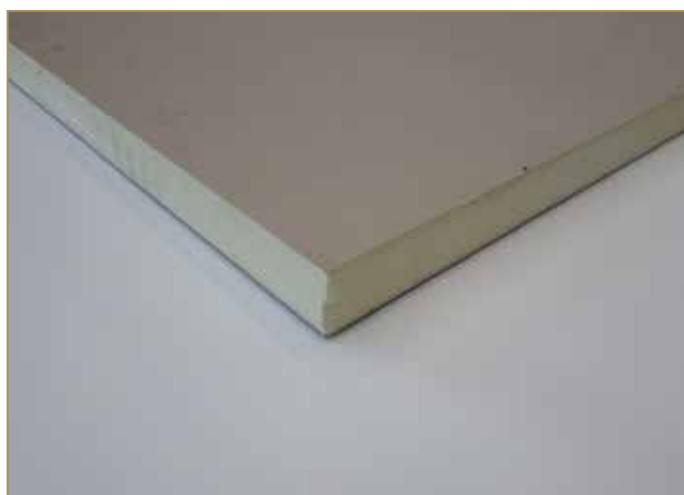

Figure 7.6: PUR/PIR insulating panel + fibre glass mat

Thermal insulation panels must always be installed by bonding to the vapour barrier (in general using POLYVAP SA or ADESOSHIELD SA double-sided self-adhesive type) and/or mechanically fixed to the roof structure. During installation of the insulation panels, please ensure removal of the release mono-silicone film as the panel is laid, to guarantee the correct adhesion.

If the upper surface of a torch applied vapour barrier is suitable, the panels can be adhered using a two-component polyurethane adhesive such as POLYGLUE PU 2K, (Fig. 7.4 - 7.5 - 7.6).

## 7.4 APPLICATION OF THE WATERPROOFING SYSTEM

Application of **ADESO**® membranes uses no naked flames (propane torch), and is carried out by simply removing the mono-silicone film on the self-adhesive underside of the membrane. The same applies to the film on the lateral and end lap selvedge for mineral granules surfaced membranes.

**ADESO**® self-adhesive membranes are not suitable to be loosely or semi-independently laid.

For an un-insulated roof, where the application of the first layer is to be applied directly to the roof deck (timber or cement screed) the surface must be suitably prepared by the application of primer. Once the membrane has been positioned on the insulating panel or surface, the first half of the mono-silicone protective film must be removed to allow the membrane to adhere. The other half of the film is then removed, paying attention that no air bubbles or creases form. While removing the film, take care to prevent the untreated grey-coloured side of the silicone release film from adhering to the self-adhesive compound. (see examples of the **ADESO**® application phases)

Continue to lay the other sheets, positioning them one next to the other, overlapping them by 10 cm at the sides and by 15 cm at the ends.

At all end lap selvedges and where the side lateral selvedges overlap, the current regulations recommend that the end lap selvedge is cut at 45° at the end of the, to increase the surface where the following sheet can adhere, ensuring a more effective seal.

## ADESO® APPLICATION SYSTEM

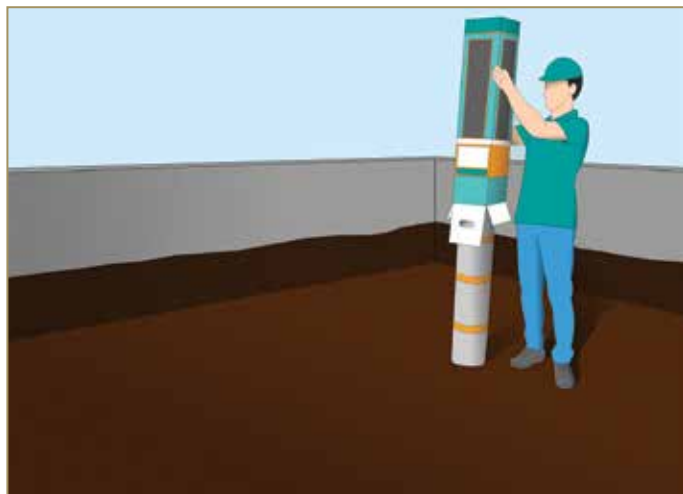

Figure 7.7: remove the roll of **ADESO**® membrane from its cardboard packaging



Figure 7.8: Unroll the membrane in its final position



Figure 7.9: Check the position of the membrane and the side overlaps with the adjacent sheets



Figure 7.10: Remove part of the release mono-silicone protective film on the bottom side, to adhere the first half of the membrane



Figure 7.11: Fold over the loose half of the membrane



Figure 7.12: Remove the second half of the release mono-silicone protective film



Figure 7.13: Remove the protective film on the side sedge of the adjacent membrane



Figure 7.14: Fold and adhere the second half of the membrane



Figure 7.15: As an alternative to Figure 7.11 - 7.12 - 7.13 - 7.14 it is possible to remove both halves of the protective film at the same time



Figure 7.16: Use a roller to ensure a proper seal at the overlaps

## RECOMMENDATIONS:

- Do not apply the material in adverse weather conditions or on substrates with a surface temperature  $< +10^{\circ}\text{C}$  or with high humidity.
- Use a suitable primer where applicable.
- Do not apply on dusty, damp or wet surfaces.
- Do not apply the material in excessive temperatures ( $< +10^{\circ}\text{C}$  or  $>$  and equal to  $+35^{\circ}\text{C}$ ).
- Do not leave the **ADESO**® roll out of its cardboard box, even when partially used
- Do not leave the cardboard box containing the membrane in a horizontal position.
- Do not stack the membrane pallets or leave them exposed to direct sun or in adverse weather conditions

## 8. SUITABLE APPLICATIONS FOR ADESO®

### 8.1 APPLICATION ON FLAT ROOFS

On flat roofs, **ADESO®** membranes are normally used as part of a multi-layer waterproofing system:

- with warm roofs, where there is a layer of thermal insulation
- with cold roofs, without a thermal insulation layer

The possible combination of the layers in compliance with the EN 13707 standard is as follows:

- Multi-layer, comprising of a first layer of 2 mm thick smooth finished membrane followed by a second layer finished with mineral granules with a weight of 3.5 kg/m<sup>2</sup>. For use on insulated systems (Warm Roofs).
- Multi-layer, comprising of a 2 mm thick smooth finished membrane used as a first layer to be torched on heat-sensitive insulating panels (expanded and/or extruded polystyrene foam) then install traditional membranes suitable to be used as a single layer under heavy protection.

All waterproofing systems are subject to annual maintenance, therefore we recommend you refer to the reference regulations or to our manual "Use, maintenance and control of waterproofing Polymer Distilled Bitumen membranes" to obtain the best possible life expectancy.

#### 8.1.1 THERMAL INSULATION APPLICATION

The installation of insulation panels, whether in a single layer or where additional layers are require to meet requirements, must always be butt jointed and have staggered end laps, in order to avoid cold bridging (see Figures from 8.1 to 8.4).

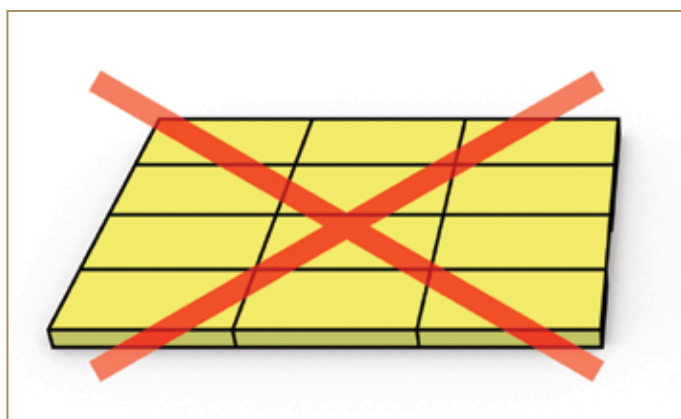

Figure 8.1: Laying insulating panels incorrectly

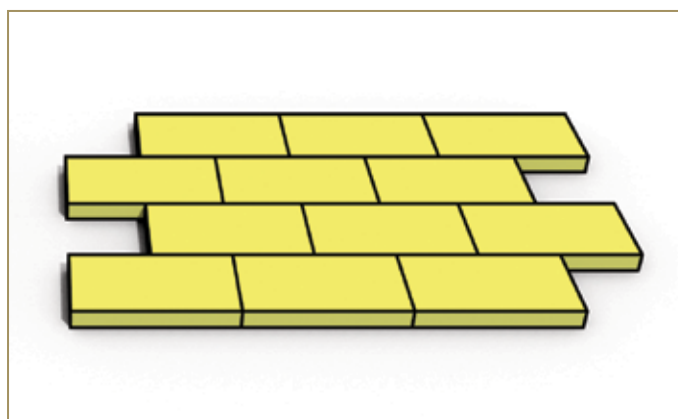

Figure 8.2: Laying insulating panels in a single layer correctly

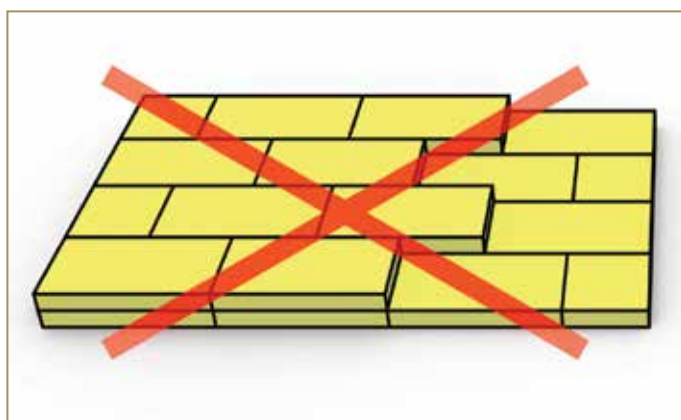

Figure 8.3: Laying insulating panels in two layers incorrectly

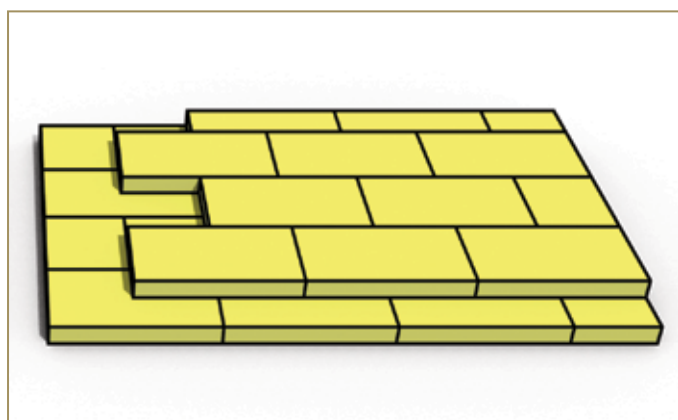

Figure 8.4: Laying insulating panels in a double layer correctly



Insulation panels may be installed using a two-component polyurethane adhesive such as POLYGLUE PU 2K, or, where suitable, by adhering to the upper-face of the **ADESO**® double-sided self-adhesive vapour barrier (Figure 8.6).

In areas subject to high wind uplift, we recommend the use of a mechanical fastening system, suitably calculated and checked by a qualified engineer/designer, in compliance with EUROCODE 1 (Figure 8.5). The fasteners must be installed in accordance with the manufacturers recommendations. Fixings should be suitable for the type of insulation / substrate and should not be positioned between panels.

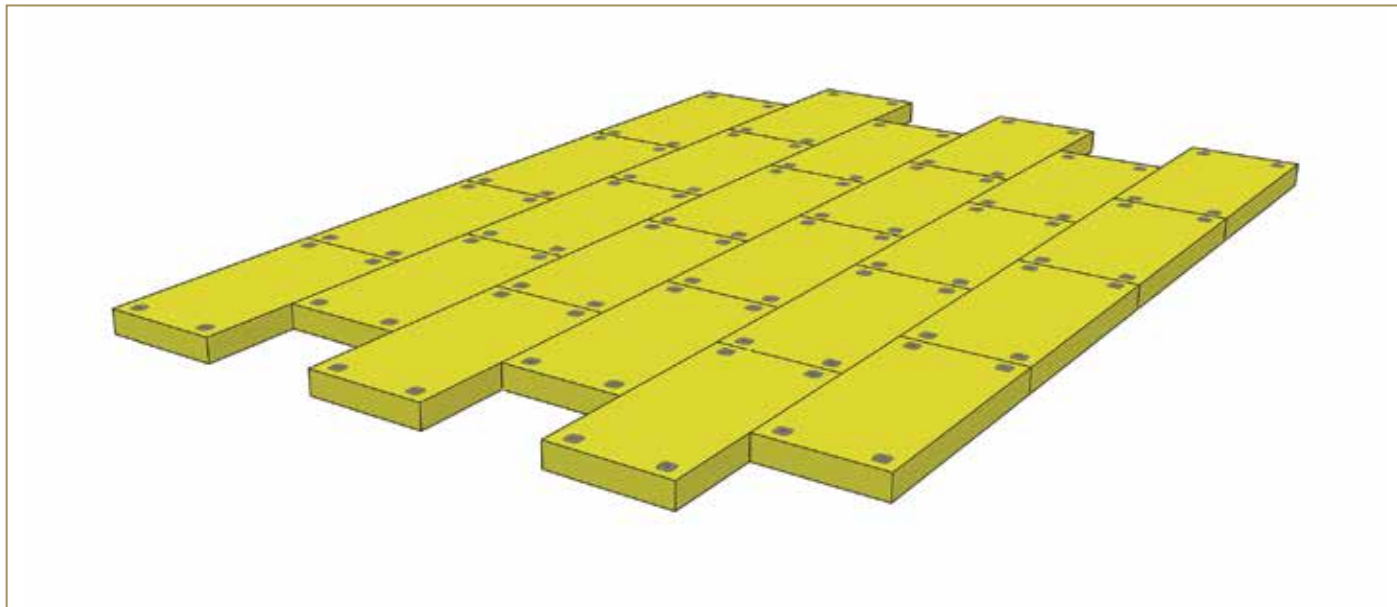

Figure 8.5: Typical mechanical fastening installation

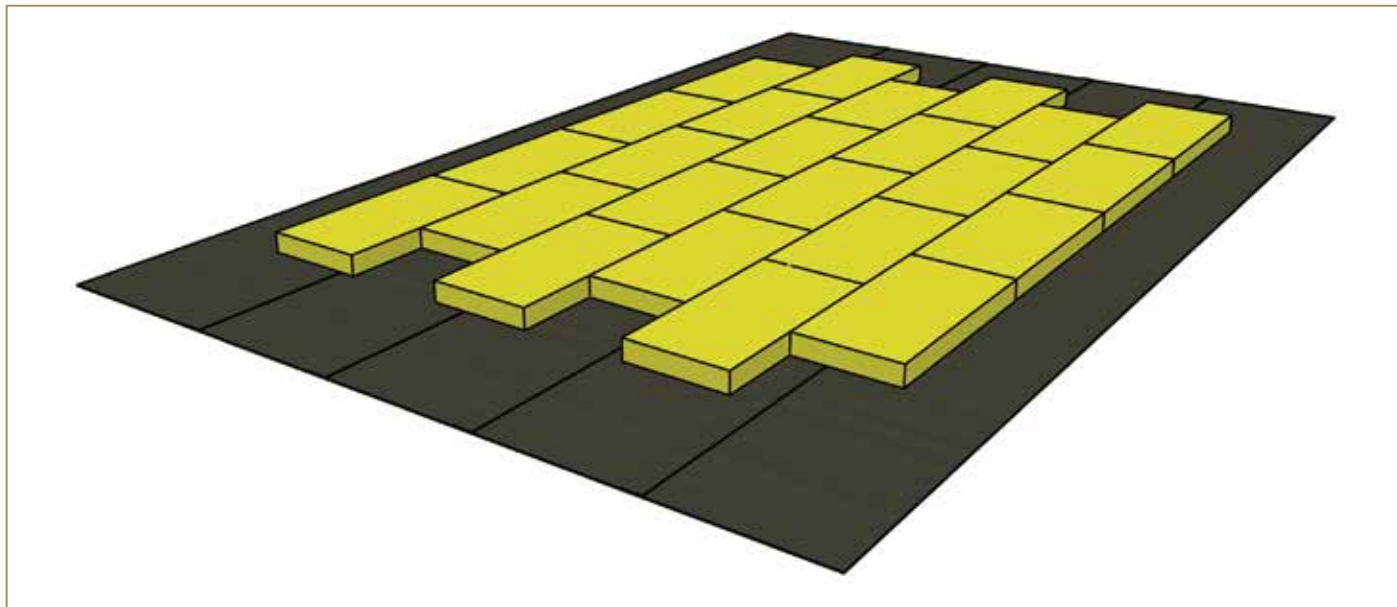

Figure 8.6: Installation on double-sided self-adhesive vapour barrier (POLYVAP SA or ADESOSHIELD SA)

When installing multi-layer panels, the second layer must be adhered to the first using a two-component polyurethane adhesive such as POLYGLUE PU 2K. (Figure 8.7). Where panels have been mechanically fixed, we recommend installing a further layer of insulation, suitably adhered to the first, with a two-component polyurethane adhesive such as POLYGLUE PU 2K (Figure 8.8) in order to reduce the possibility of thermal bridging,

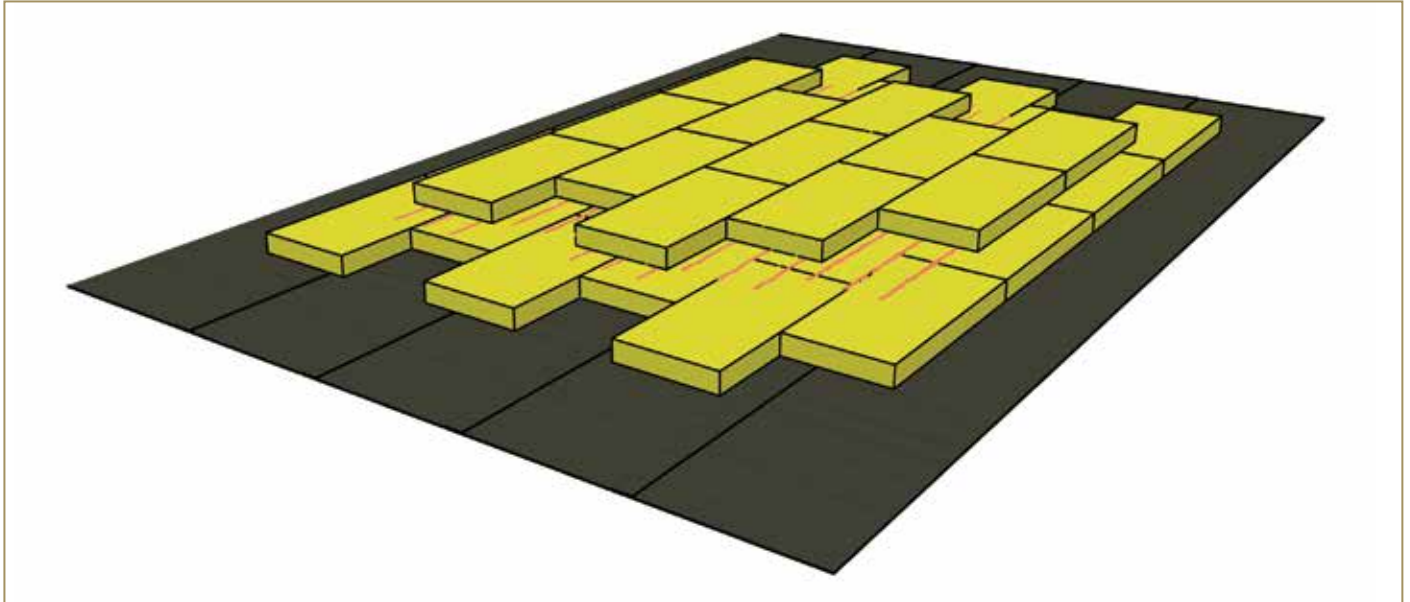

Figure 8.7: Installing insulation panels on double-sided self-adhesive vapour barrier (POLYVAP SA or ADESOSHIELD SA) with an adhered second layer

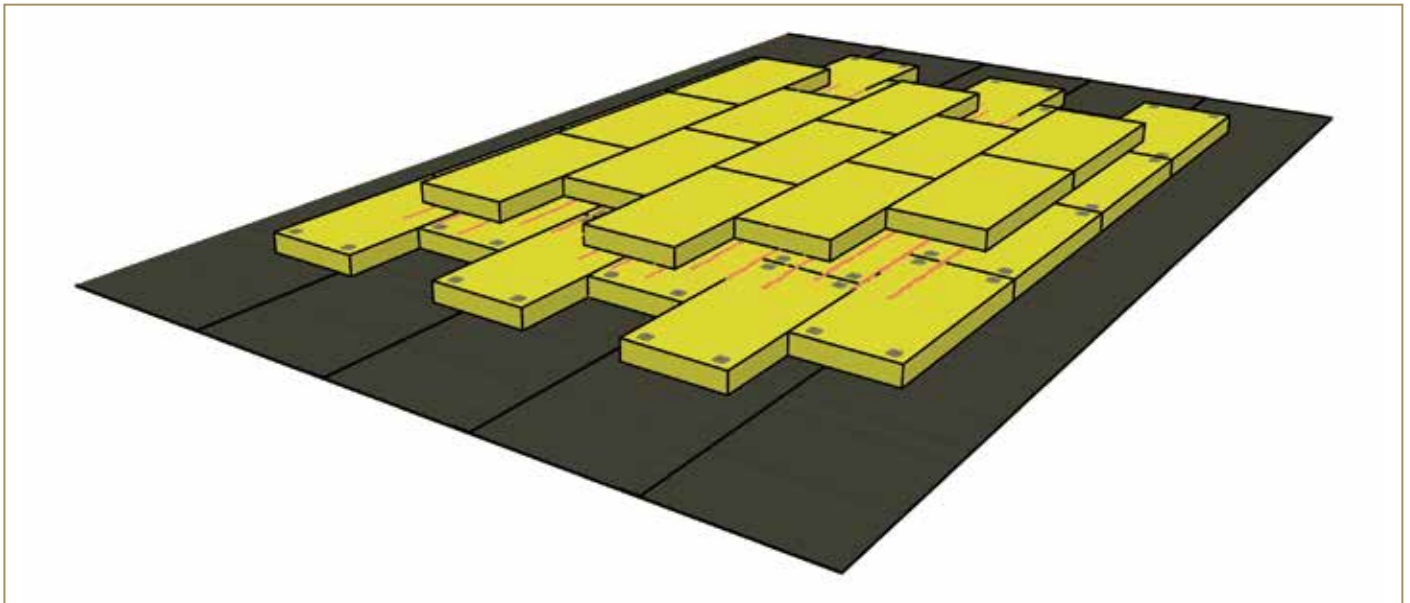

Figure 8.8: Installation with mechanical fastening of the insulation with an additional adhered layer

## 8.1.2 APPLYING THE FIRST WATERPROOFING LAYER

To ensure the best possible life expectancy from a roof, we recommend that they **have a slope of no less than 1%**. This helps to avoid the formation of ponding water and the associated problems it creates.

Positioning of the membranes must always comply with the direction of the slope and the drainage of the rain towards the outlets present on the roof. After laying the first sheet, it is possible to lay the second waterproof sheet adjacently (side lateral selvedge), taking care to offset the overlap at the beginning of the roll by a few metres (Figure 8.9) and making the cut at 45° (Figure 8.12).

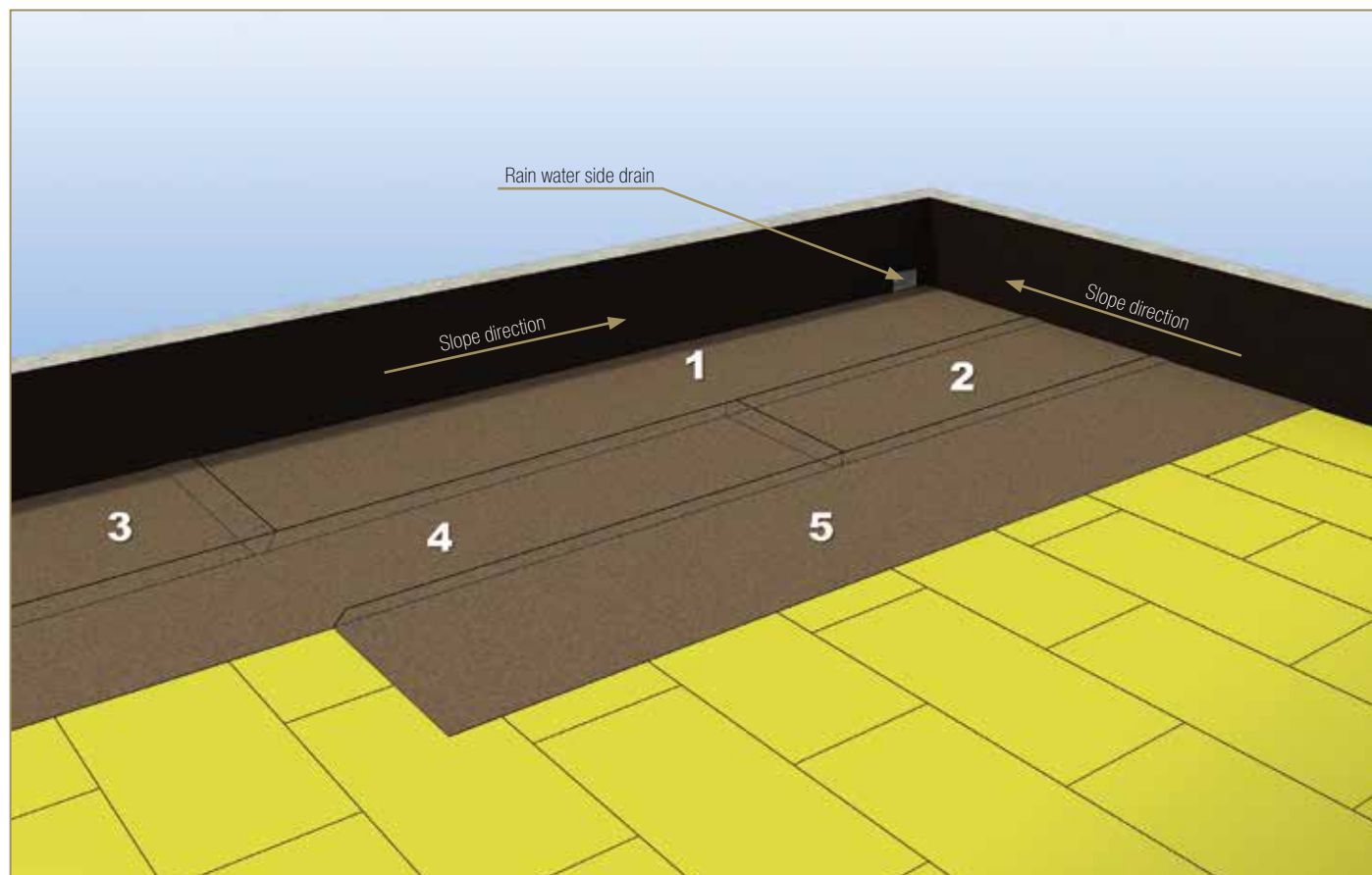

Figure 8.9: Positioning the insulating layer and the waterproof membranes according to the rain runoff direction

**On roofs with slope  $\leq 5\%$** , the roll can be laid both parallel and transversal to the eaves line, but always start by laying the membrane from the lowest point of the roof, where the drain outlets are positioned. In this way, the membrane will continue to the top of the slope with the overlaps in the correct direction.

If an insulating layer is present, the membranes must be laid perpendicular to the continuous conjunction lines of the panels. The movement and thermal expansion of the panels, combined with incorrect installation of the waterproofing layer, can cause stress and bumps or cracks on the surface of the roof. Laying the membranes, both on insulating panels and directly on the base surface (timber or cement), must be carried out avoiding four overlaps of the beginning/end of the rolls. Correct installation provides for both the first and the second waterproof layer, to be always offset longitudinally (Figure 8.10) or by the inclusion of a transversal roll along the end lap selvedges (Figure 8.11). In this case, if the second mineral granules surfaced membrane layer is applied with the same method, the transversal sheet must not be positioned overlapping the one below.



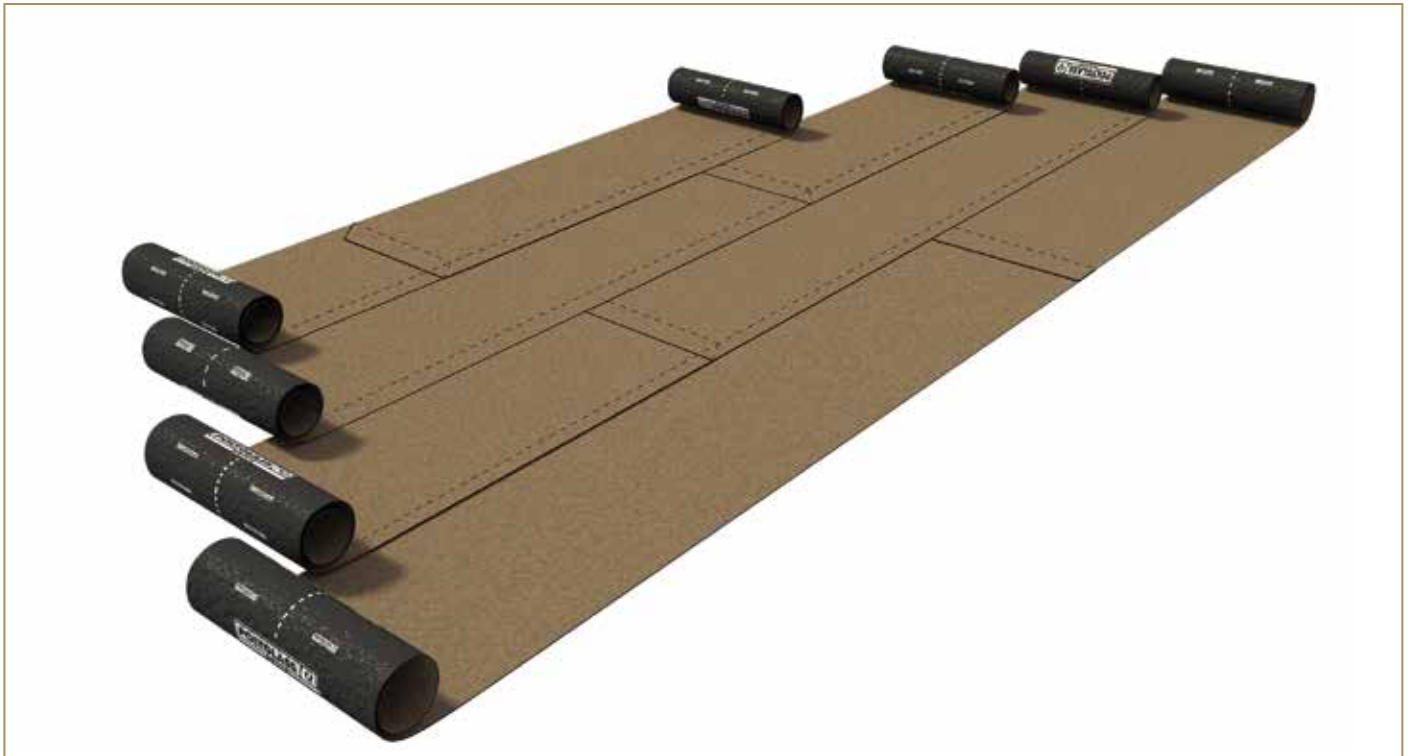

Figure 8.10: Offset laying of the first waterproofing membrane

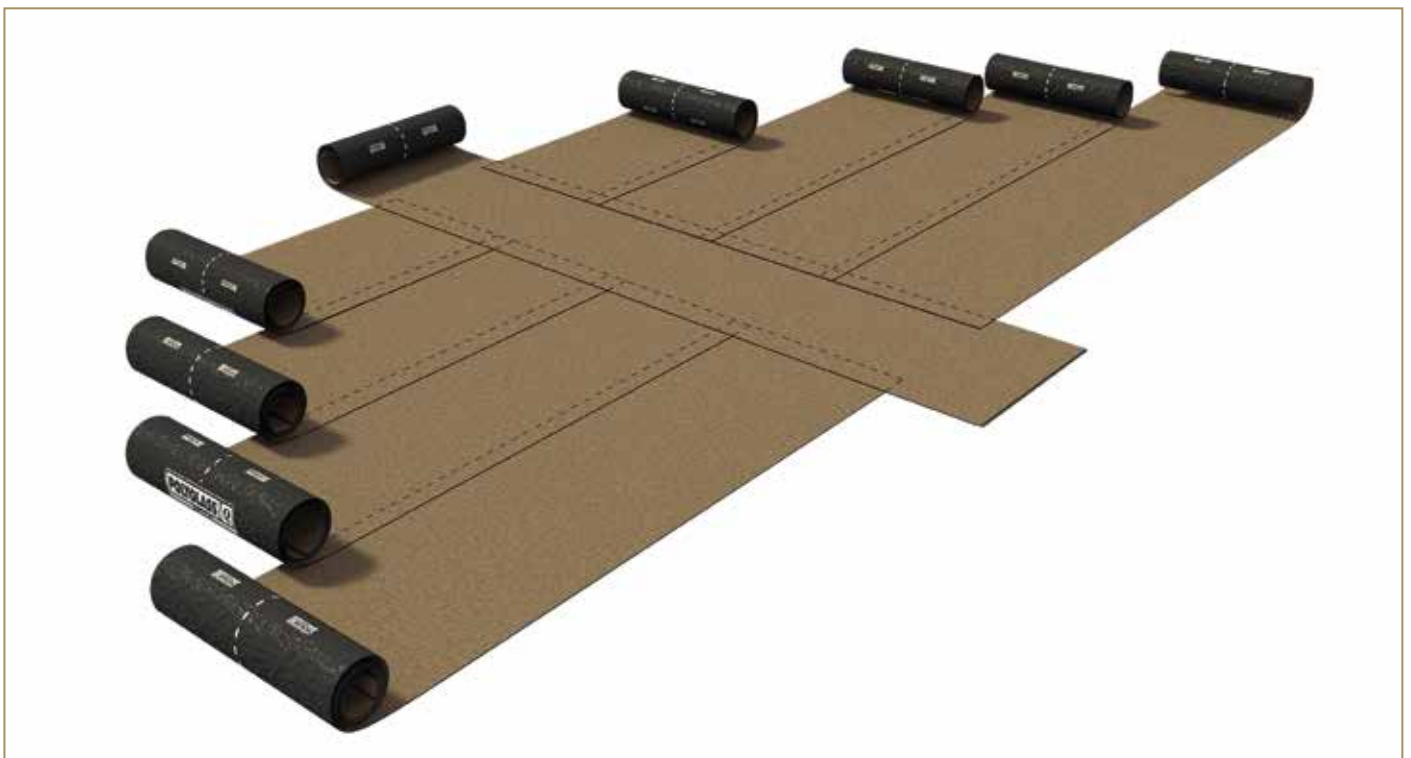

Figure 8.11: Alternative offset laying of the first waterproofing membrane

As shown in the drawing (Figure 8.9), the membranes of the first waterproof layer are laid on the horizontal surface of the roof and interrupted where they intersect with the vertical turn-ups of the perimeters or protruding structures.

As provided for by the current regulations, all the vertical turn-ups of the waterproof system along the perimeters or protruding structures of the roof (i.e. chimneys and skylights) must be continuous and the membrane of the horizontal surface must be interrupted and the vertical turn-up made separately (see Figures 8.17 and 8.18). According to the height of the vertical turn-up, a portion of the membrane is cut and used to line the vertical surface, overlapping the previously laid flat membrane with an overlap of at least 10 cm.

The joint of this overlap and all technical features (corners, vents, outlets, etc.) must be made using a manual Leister-type hot air welding tool; the use of a propane torch is not allowed.

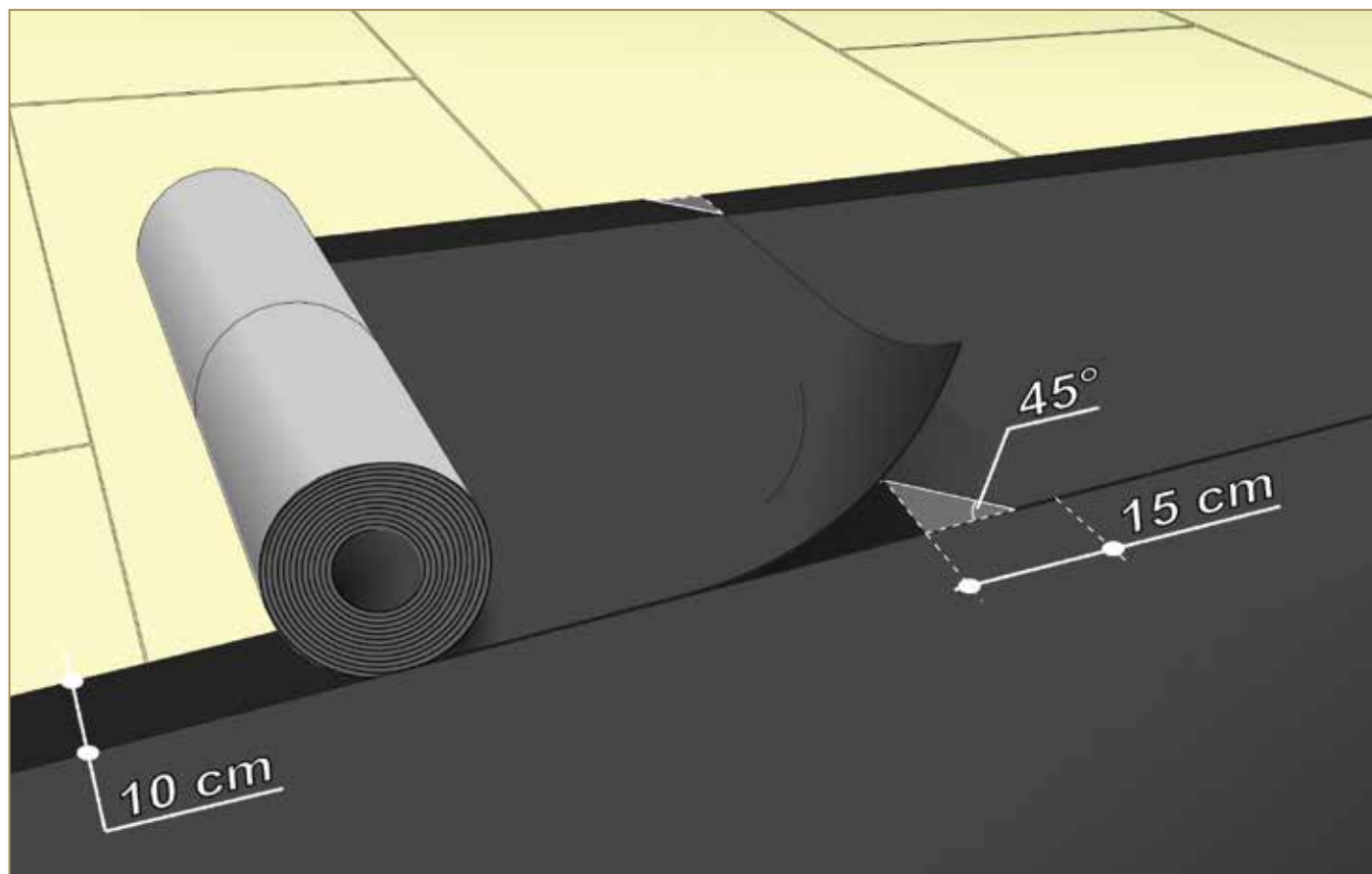

Figure 8.12: Realization of the overlap at the beginning of the roll

### 8.1.3 APPLYING THE SECOND WATERPROOFING LAYER

In exposed roofs, the upper face of a second layer membrane must be protected with slate chippings or mineral granules. The bonding process of the bitumen compound to the adjoining membrane along the end lap overlapping requires the use of the Leister hot air welding tool (Figure 8.13, Figure 8.14 and Figure 8.15). We do not recommend the use of naked flame torches.

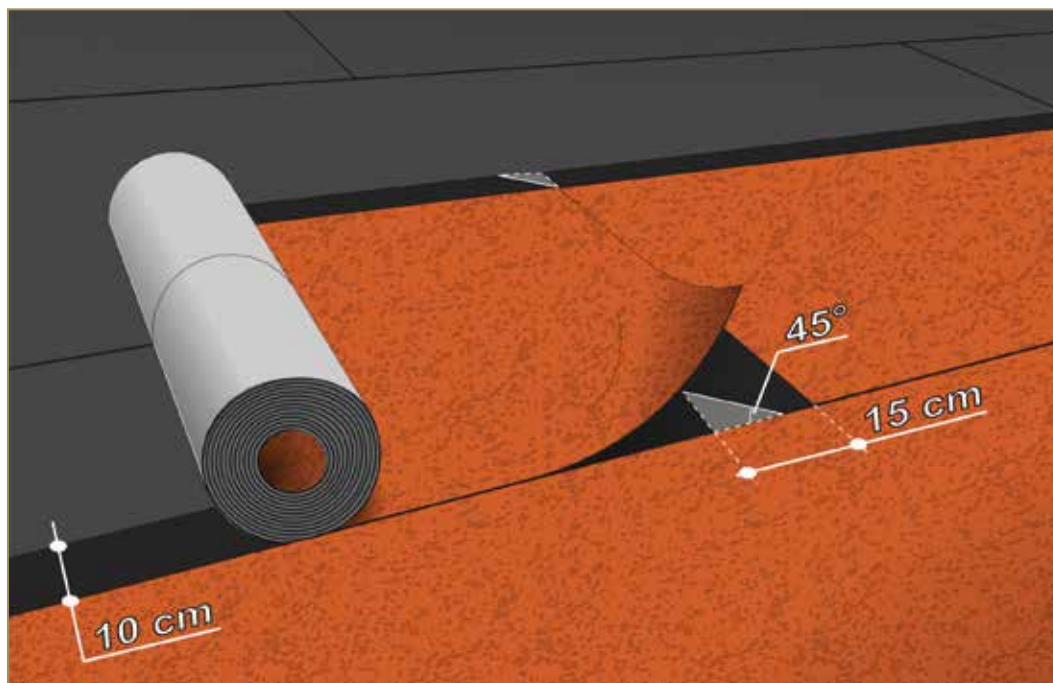

Figure 8.13: Realization of the overlap at the beginning of the roll with granule free end-lap.

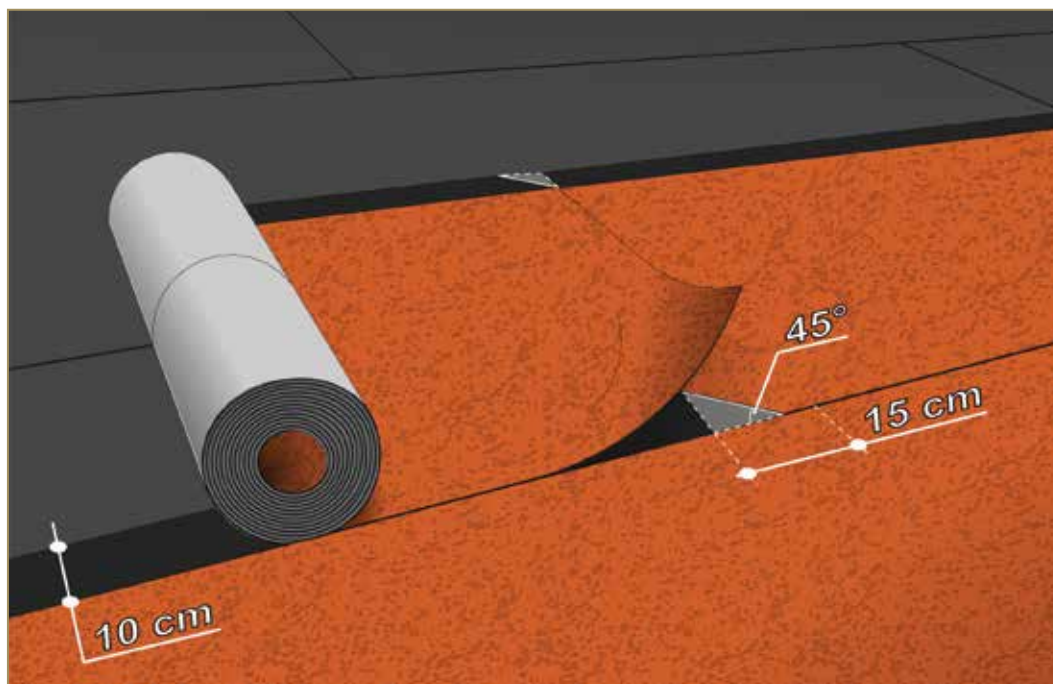

Figure 8.14: Realization of the overlap at the beginning of the roll without granule-free end-lap.



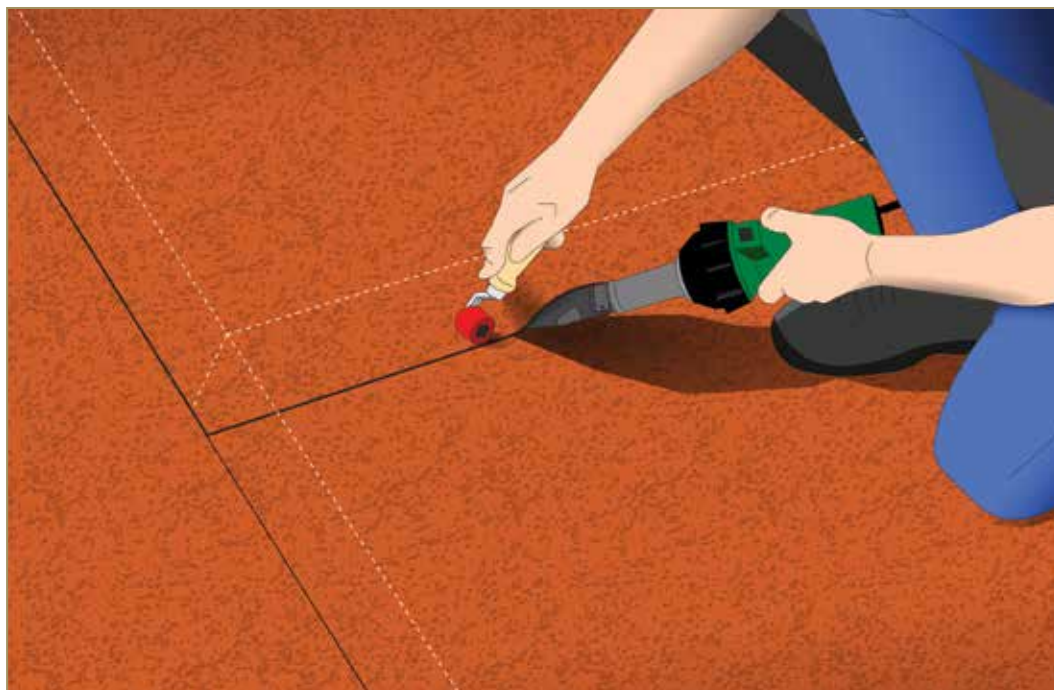

Figure 8.15: Lap bonding using a Leister-type manual hot air welding tool

Rolls of the second waterproof layer must be laid longitudinally to the first layer, offset, both transversal and longitudinal, greater than or equal to the width of the welding joint (Figure 8.16).

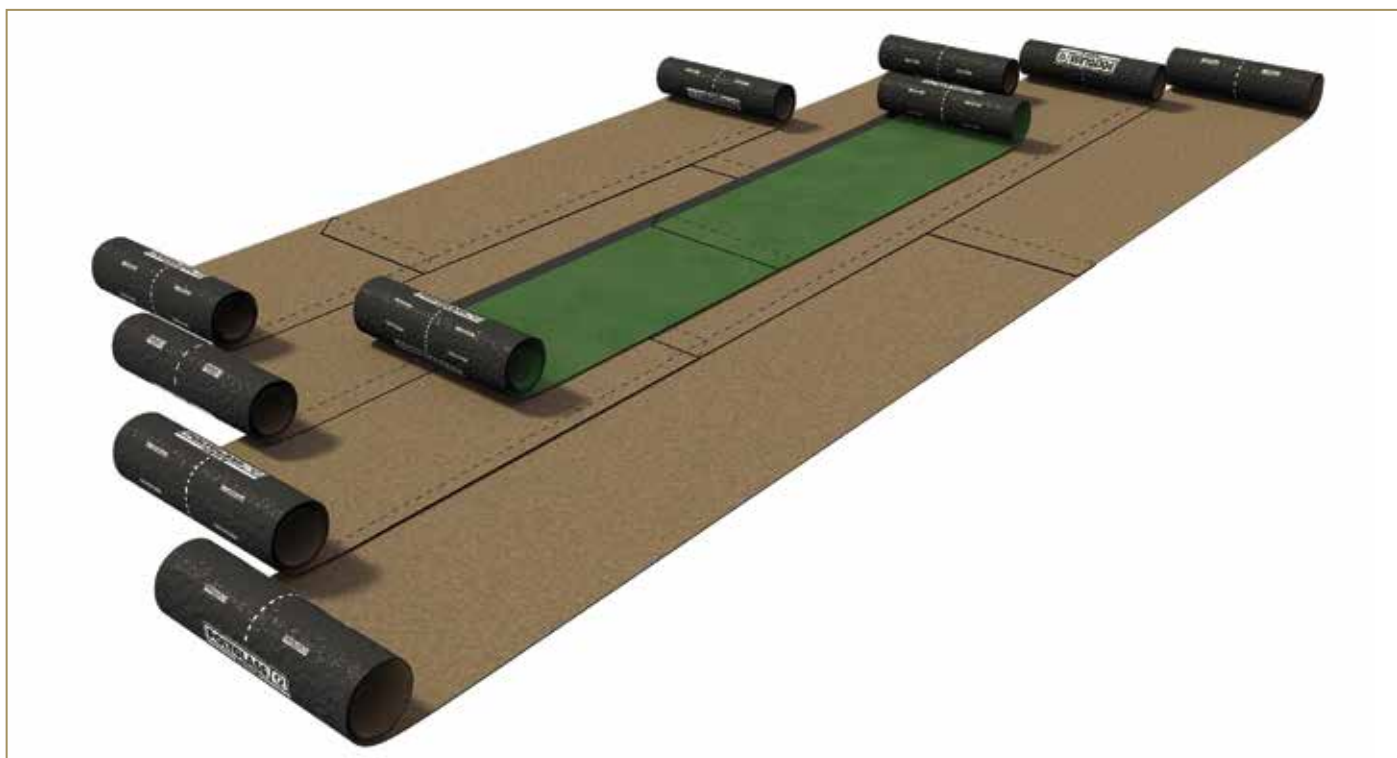

Figure 8.16: Offset laying of the second waterproofing membrane

Once the second layer has been laid, the second vertical up-turn must be made, offsetting the overlaps of the second vertical up-turn with regard to those of the first one. The second vertical up-turn must exceed by at least 10 cm the first up-turn, and the overlap in the flat part must be about 20 cm, in order to always exceed the size of the previous overlap.

All welding and technical features (such as corners) must be made using a Leister-type manual hot air welding tool, with a 40 mm nozzle for the flat part and a 20 mm nozzle for the technical features. The height of the vertical turn-up must be a minimum of 15 cm above the finished roof surface to ensure continuity of the waterproofing.

Where the membrane terminates on the top of the retaining wall (Figure 8.17), or, if the vertical up-turn terminates on the vertical part of the wall (Figure 8.18), membranes must be mechanically fixed using a capped flashing with a pre-finished galvanized flashing or a suitably thick stainless steel termination bar (a minimum thickness of 6/10 mm is recommended). The profile must then be closed and sealed on the top using POLYDETAIL MS or an equivalent sealant.

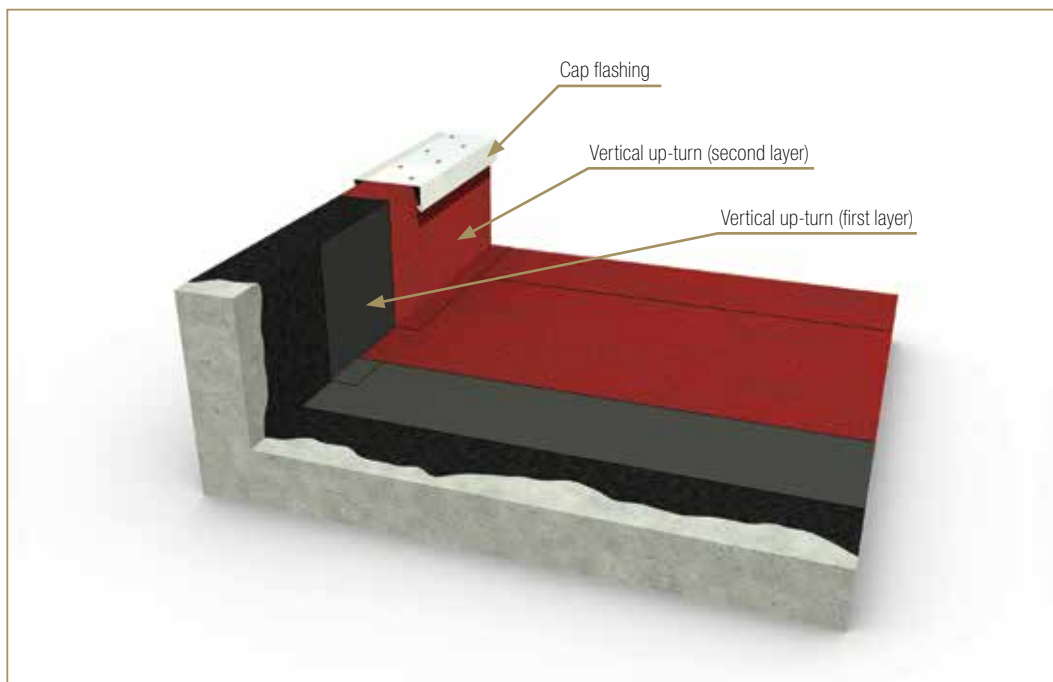

Figure 8.17: Capped vertical up-turn

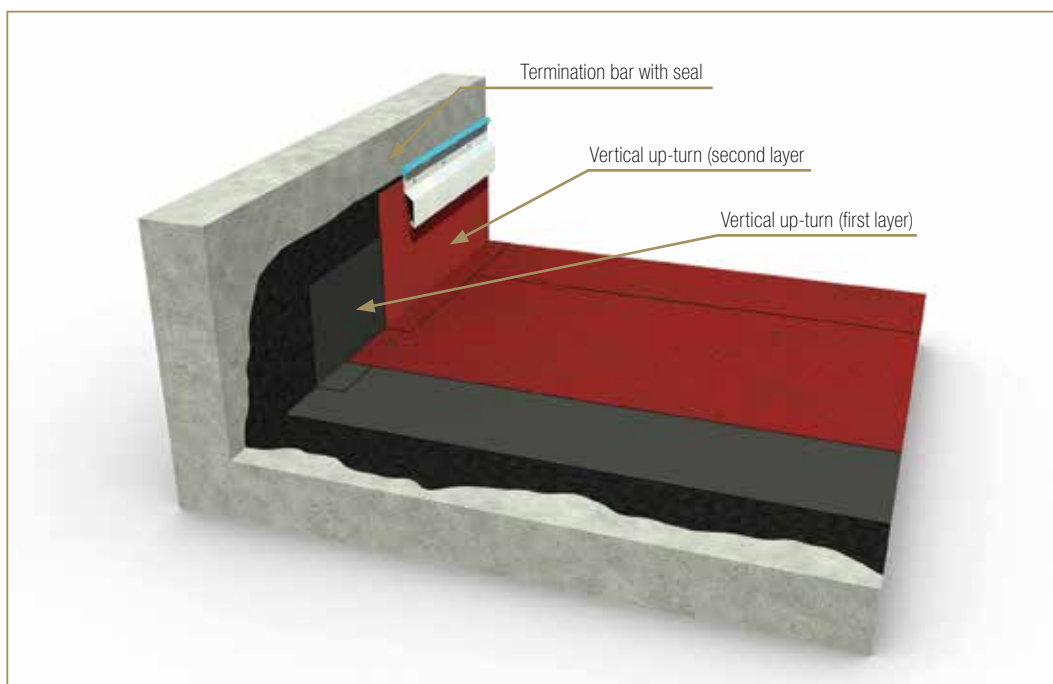

Figure 8.18: Vertical up-turn with termination bar



## 8.1.4 ADDITIONAL SURFACE FINISHING

The mineral granule surfaced versions of **ADESO**® membranes can be further protected, after at least a three months oxidation period, by the application of a solvent-based paint such as POLYVER SUPER WHITE or water-based such as POLYSINT SUN REFLECT.

It is also possible to improve the adhesion of the mineral granules to the membrane by using a transparent sealer such as MINERAL FIX. Please see the relative technical sheets and the SPECIAL PRODUCTS catalogue for all technical and application details for these products.

## 8.1.5 NEW ROOFS

Example of build-up in an exposed non insulated roof (BM1.0 Build-up) and insulated roof (BM1.1 Build-up)

### BUILD-UP BM1.0

#### Exposed roof - Non insulated

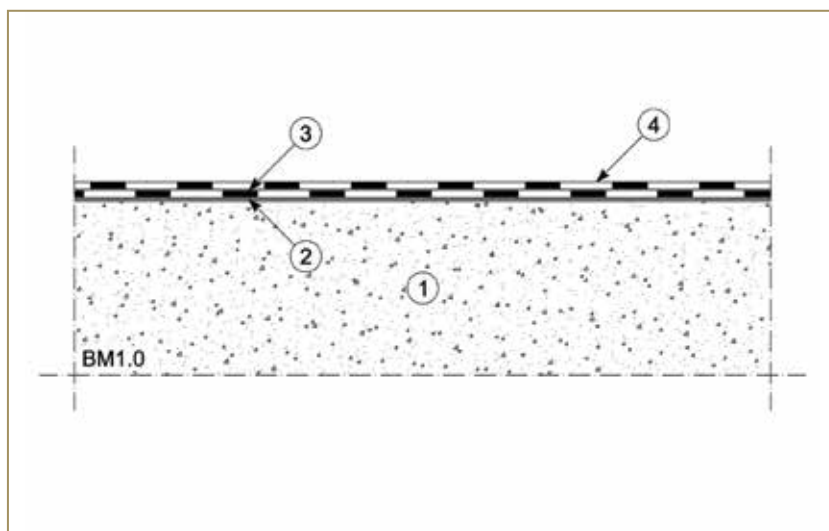
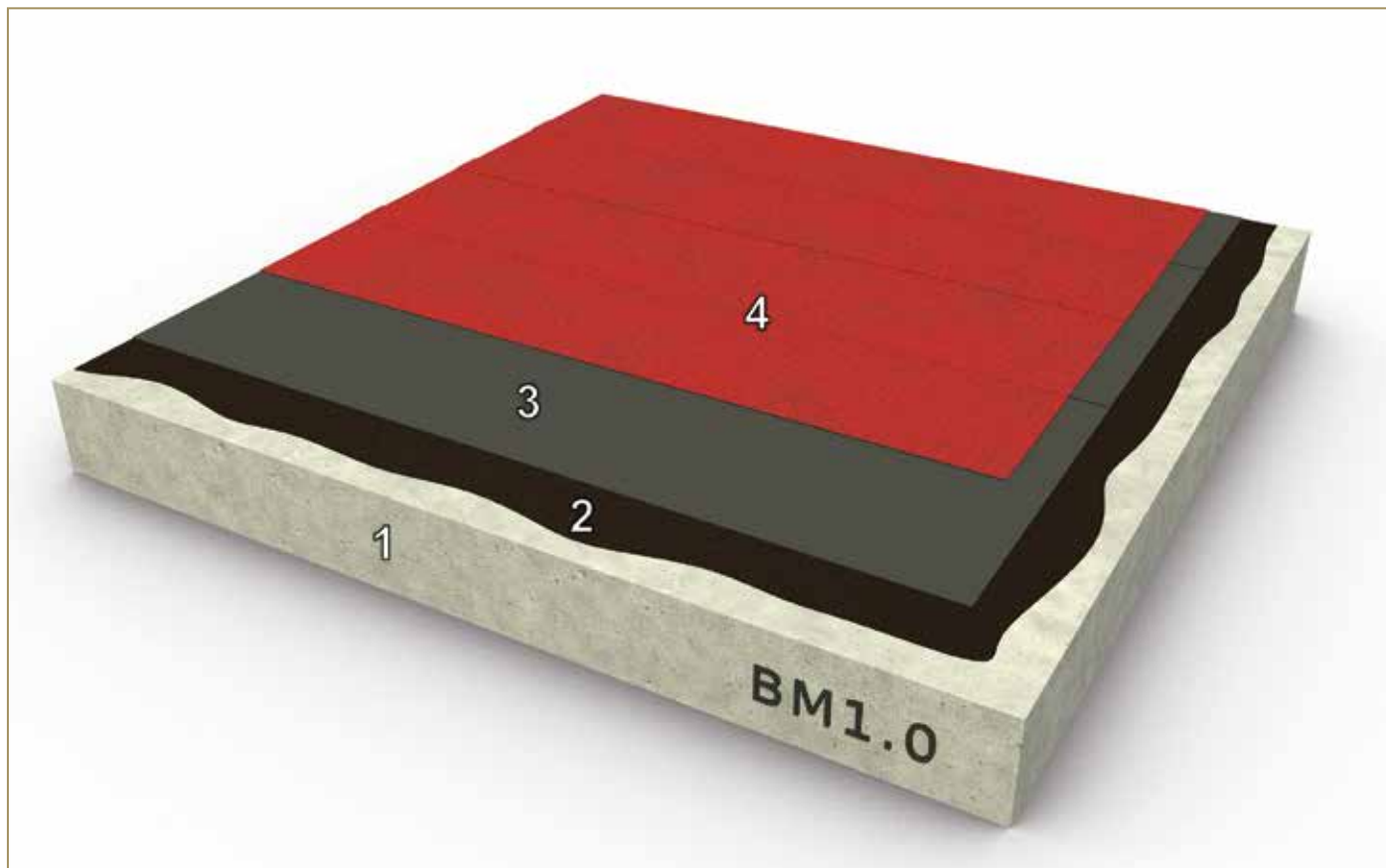

- ① Substrate/Roof deck
- ② Bituminous primer (for example **IDROPRIMER**)
- ③ Waterproofing bituminous membrane **ADESO**<sup>®</sup> (1<sup>st</sup> layer)
- ④ Waterproofing bituminous membrane **ADESO**<sup>®</sup> with mineral surface (2<sup>nd</sup> layer)

## BUILD-UP BM1.1 Exposed roof - Insulated

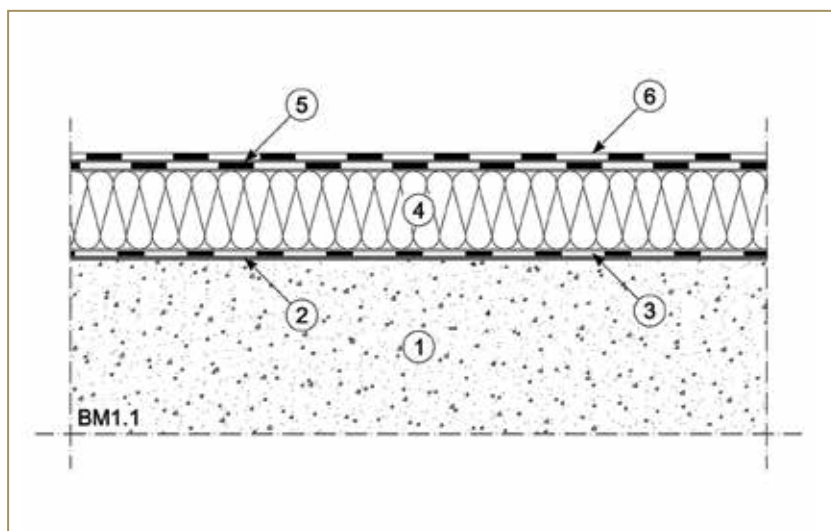
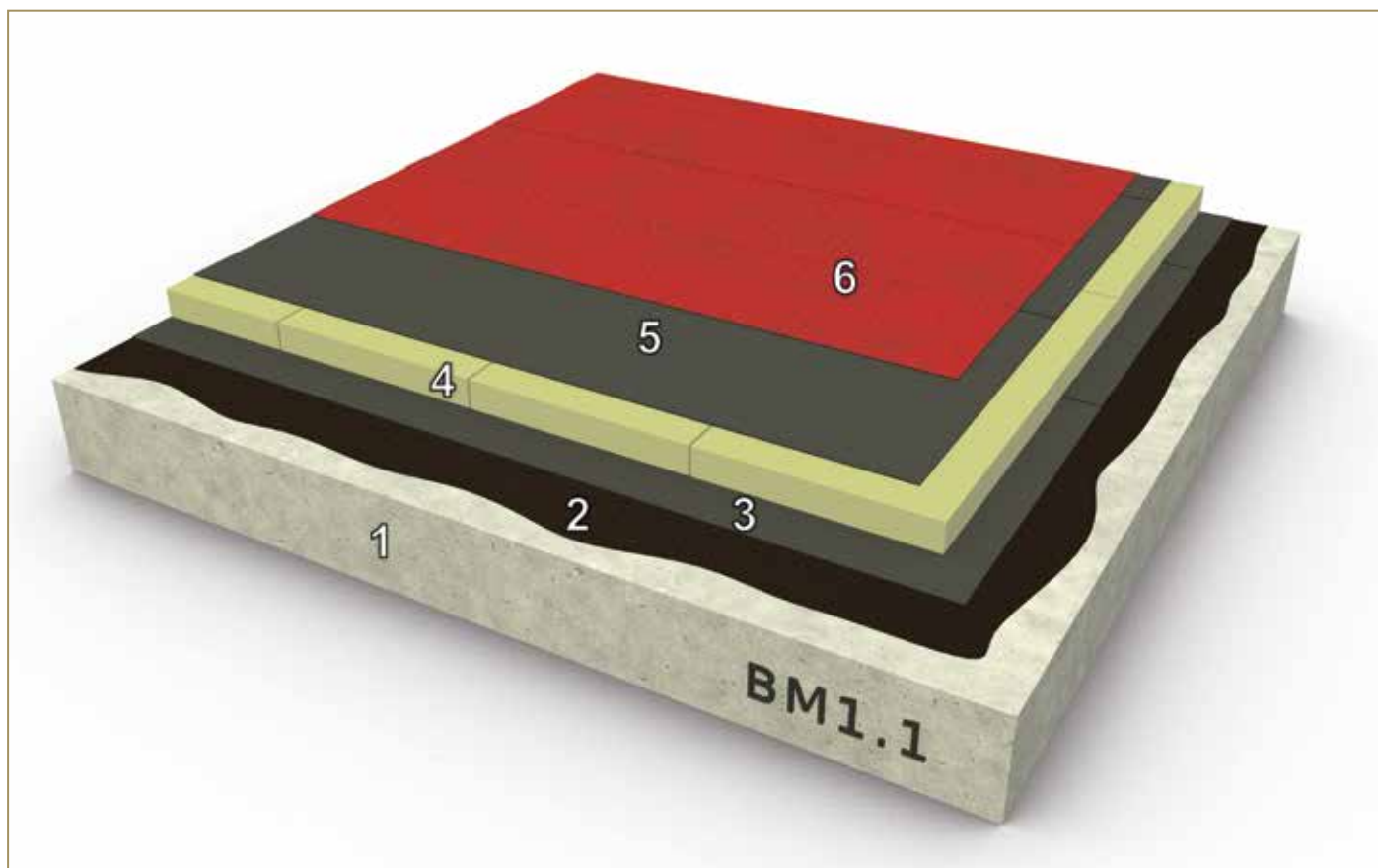

- ① Substrate/Roof deck
- ② Bituminous primer (for example **IDROPRIMER**)
- ③ Vapour barrier (for example **POLYVAP SA**)
- ④ Thermal insulation panel
- ⑤ Waterproofing bituminous membrane **ADESO**<sup>®</sup> (1<sup>st</sup> layer)
- ⑥ Waterproofing bituminous membrane **ADESO**<sup>®</sup> with mineral surface (2<sup>nd</sup> layer)



## 8.1.6 **ADESO**® SYSTEMS INCORPORATING TRADITIONAL TORCH-ON MEMBRANES

### BUILD-UP BM10.0

#### Walkable roofs - Paving on a cement screed

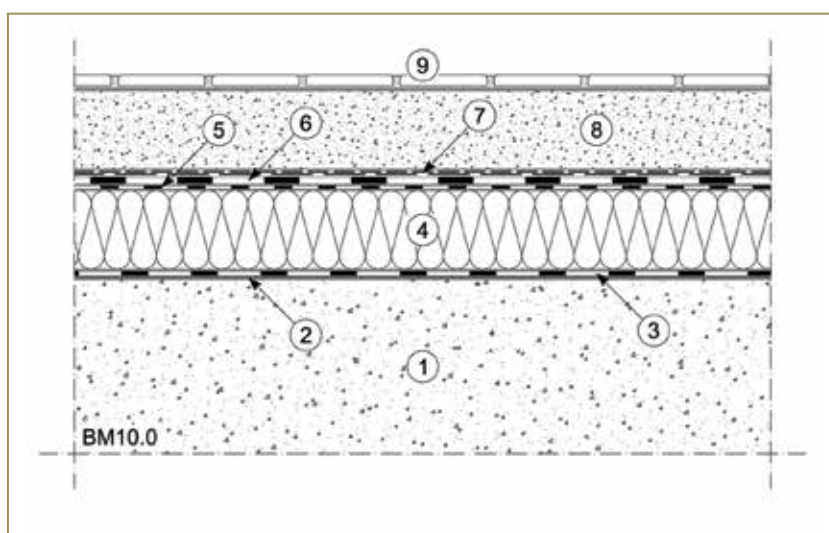
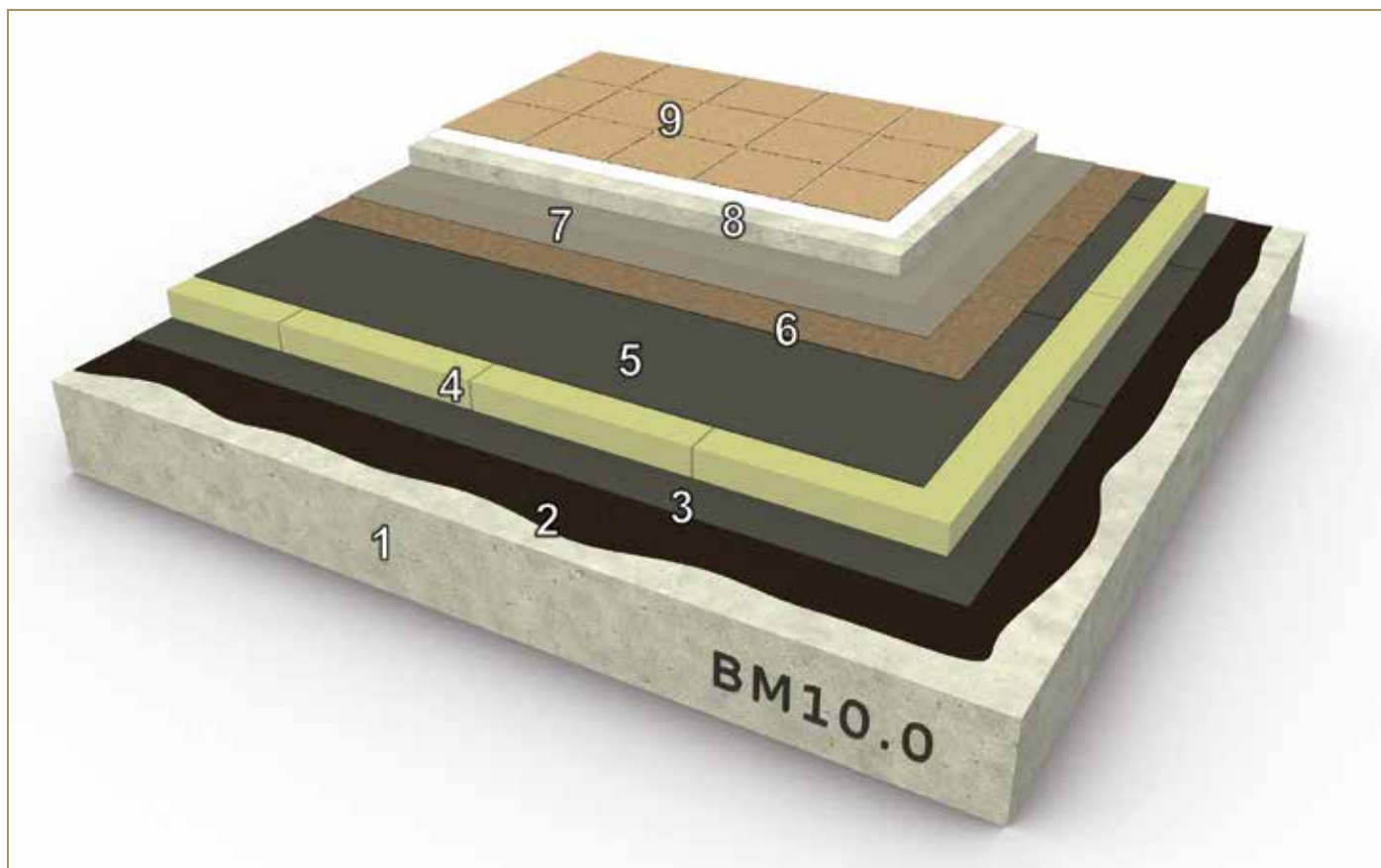

- ① Substrate/Roof deck
- ② Bituminous primer (for example **IDROPRIMER**)
- ③ Vapour barrier (for example **POLYVAP SA**)
- ④ Thermal insulation panel
- ⑤ Waterproofing bituminous membrane **ADESO**® protective layer anti-flame)
- ⑥ Waterproofing bituminous membrane (Torch applied) \*
- ⑦ Double separation layer in LDPE **MAPEPLAN PE macro-perforated** + **MAPEPLAN PE micro-perforated**
- ⑧ Protective screed with reinforced concrete
- ⑨ Paving

\* Torch-on bituminous membrane suitable for roof application on single ply.

## BUILD-UP BM10.1 Green roof

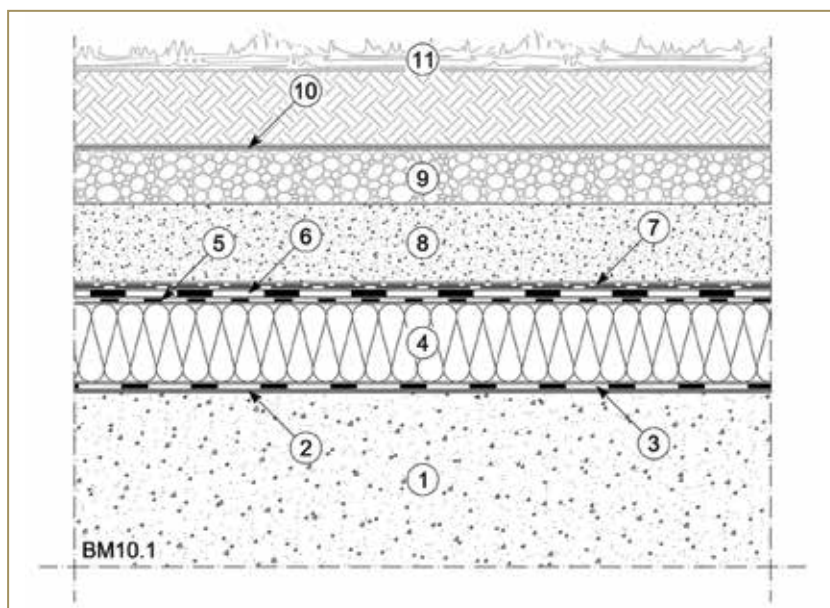
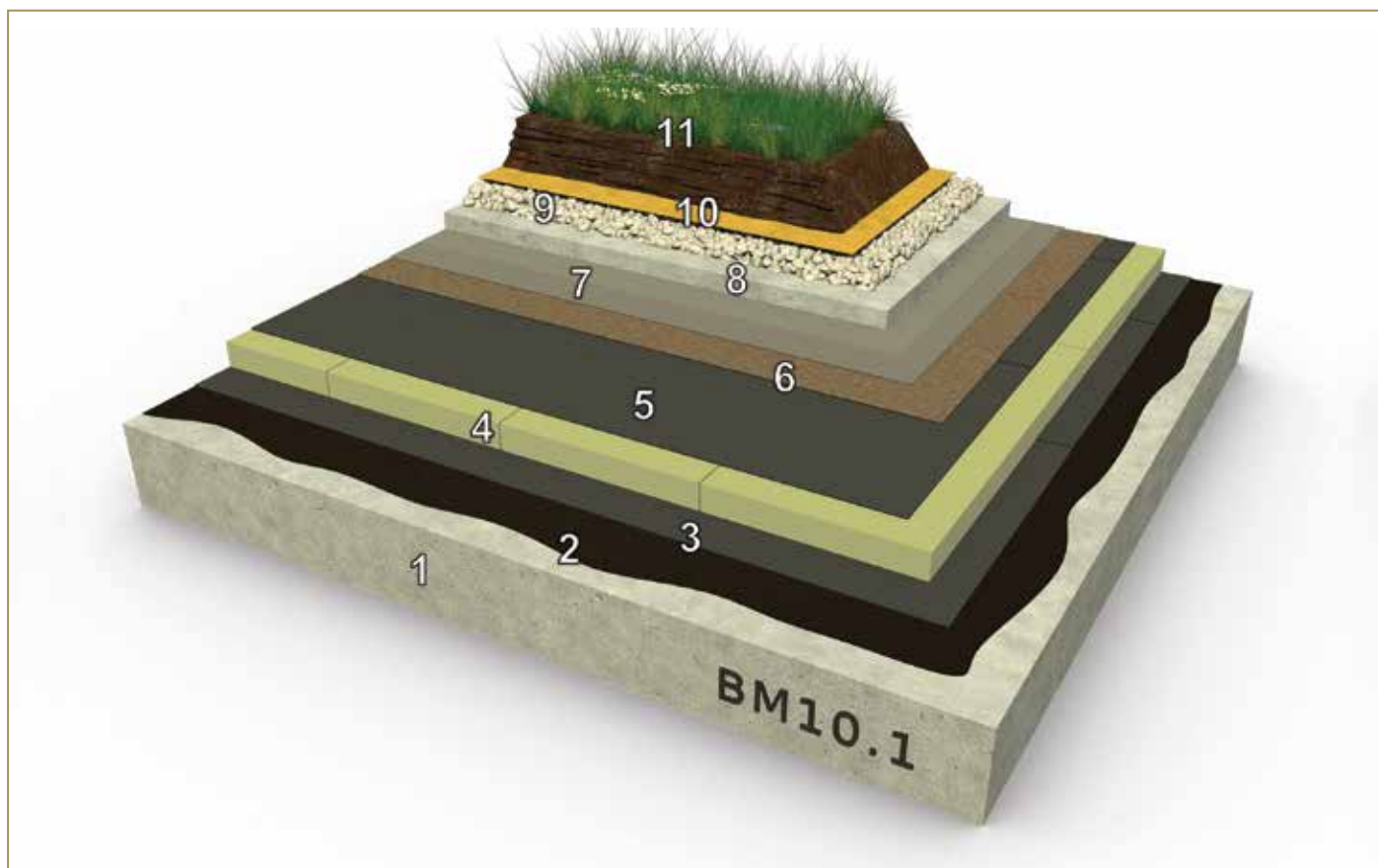

- ① Substrate/Roof deck
- ② Bituminous primer (for example **IDROPRIMER**)
- ③ Vapour barrier (for example **POLYVAP SA**)
- ④ Thermal insulation panel
- ⑤ Waterproofing bituminous membrane **ADESO**® protective layer anti-flame)
- ⑥ Waterproofing bituminous membrane **POLYGLASS ANTI-ROOT** (Torch applied) \*
- ⑦ Double separation layer in LDPE **MAPEPLAN PE macro-perforated** + **MAPEPLAN PE micro-perforated**
- ⑧ Protective screed with reinforced concrete
- ⑨ Drainage layer with gravel
- ⑩ Filtering layer **POLYDREN**
- ⑪ Soil and vegetation

\* Torch-on bituminous membrane suitable for application under soil (anti-root).

## 8.1.7 REFURBISHMENT

### BUILD-UP BM11.1

Exposed roof - Refurbishment with improved thermal insulation

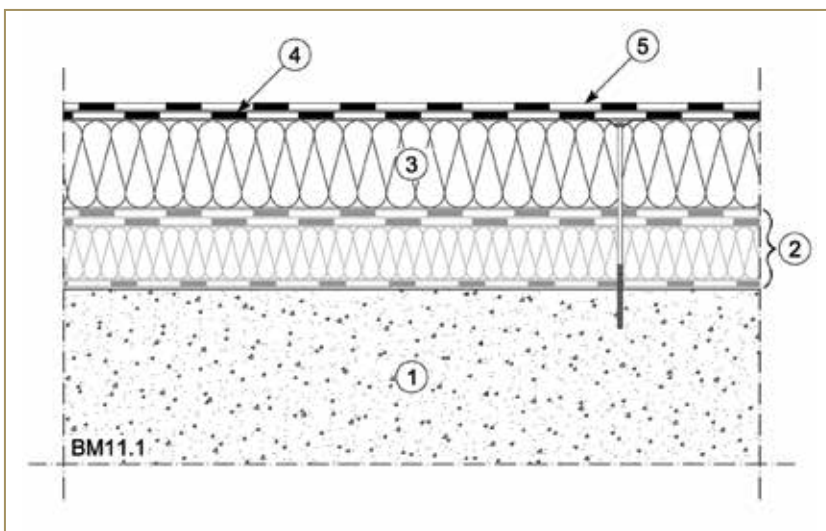

- ① Substrate/Roof deck
- ② Existing waterproofing build-up
- ③ Additional insulation layer mechanically fixed
- ④ Waterproofing bituminous membrane **ADESO**<sup>®</sup> (1<sup>st</sup> layer)
- ⑤ Waterproofing bituminous membrane **ADESO**<sup>®</sup> with mineral surface (2<sup>nd</sup> layer)

## 8.2 SLOPING ROOFS

On sloping roofs, the **ADESO**<sup>®</sup> membranes are used to create a waterproofing system in compliance with EN 13707 standard, or as safety waterproofing membrane under tiles, in compliance with the EN 13859-1 standard.

The membranes, either exposed or under tiles, must always follow the direction of the slope (perpendicular to the ridge and/or eaves line) and must be laid starting from the highest point of the pitch. Along the ridge lines, the membranes must be turned up for about 20÷30 cm on the adjacent pitch and bound with mechanical fasteners along the beginning of the roll. This application system aims at preventing the membranes from slipping, since it is hindered by the internal reinforcement, something that would not take place if the membranes were laid parallel to the eaves line.

In the presence of connections between the pitch and vertical wall, the membranes must be turned up on the latter for at least 15 cm, to allow the installation of a mechanical fastening system aimed at preventing any slippage.

### 8.2.1 ROOFS WITH EXPOSED MEMBRANES

The installation of exposed waterproofing systems on sloping roofs provides should contain two layers of waterproofing membranes. As previously described, the second waterproof layer must be applied in the same direction as the first one, taking care to offset the lateral overlaps (side lateral selvedge joining two sheets). The upper face of a membrane of the second layer of an exposed roof must always be protected by mineral granules. To help maintain and maximize the lifespan of the roof, the final waterproofing layer can be protected using one of Polyglass's SPECIAL PRODUCTS, as previously described and stated in the relative technical sheets.

On build-ups without an insulating layer and slope greater than or equal to 30% and on thermally insulated build-ups with slopes greater than or equal to 20%, in order to guarantee the stability of the membrane and thermal insulation, we recommend to installing a mechanical fastening system, with suitable fixings and washers on concrete substrates, or with wood screws and metal washers on timber substrates, applied underneath the side lateral and end lap selvedges line of the first waterproof layer. Ensure that the mechanical fasteners are then fully covered by the lateral selvedge of the adjacent layer.

Finally, we recommend you use a softwood timber batten of the same thickness as the insulating layer, placed on the pitch along the eaves line, in order to restrain the panels. This is in addition to mechanically fixing each individual panel as previously described.

## BUILD-UP BM8.0 Sloped exposed roof - Non insulated

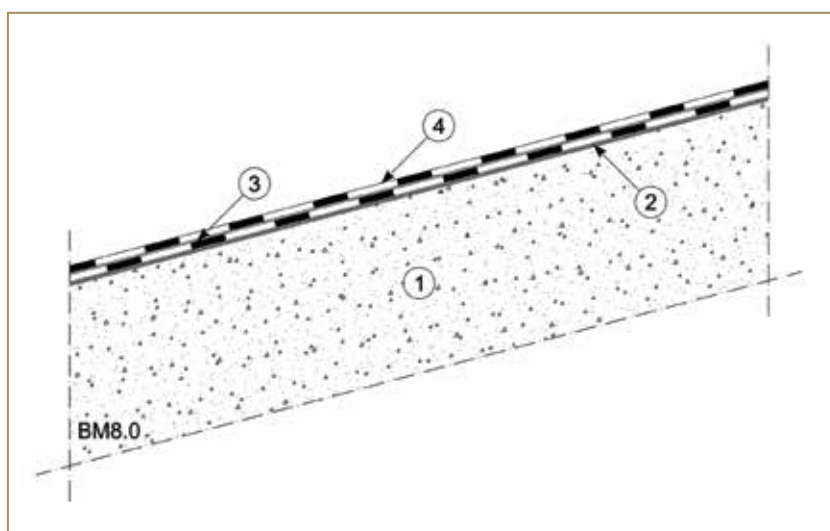
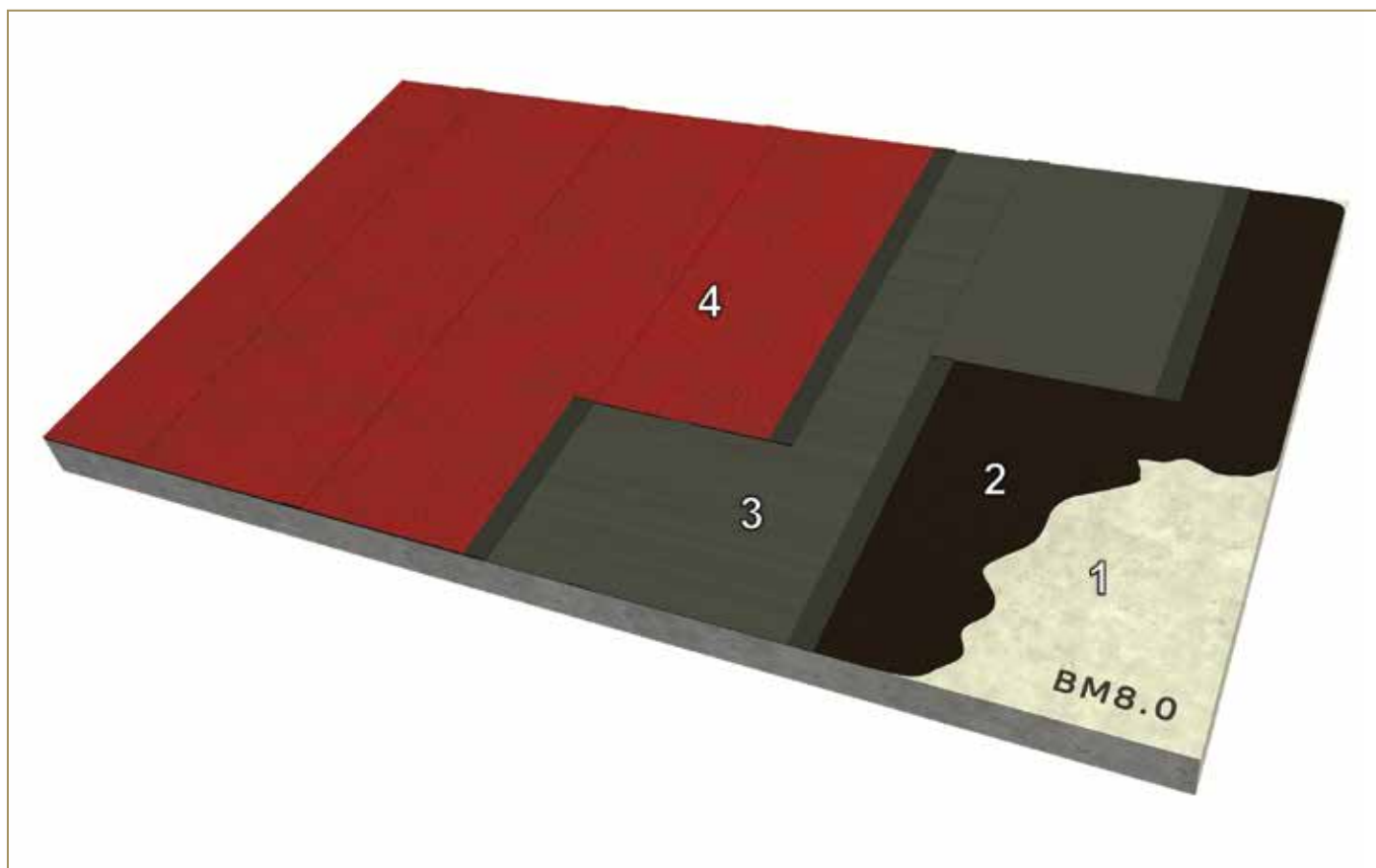

- ① Substrate/Roof deck
- ② Bituminous primer (for example **IDROPRIMER**)
- ③ Waterproofing bituminous membrane **ADESO**<sup>®</sup> (1<sup>st</sup> layer)
- ④ Waterproofing bituminous membrane **ADESO**<sup>®</sup> with mineral surface (2<sup>nd</sup> layer)

## BUILD-UP BM8.1

### Sloped exposed roof - Insulated

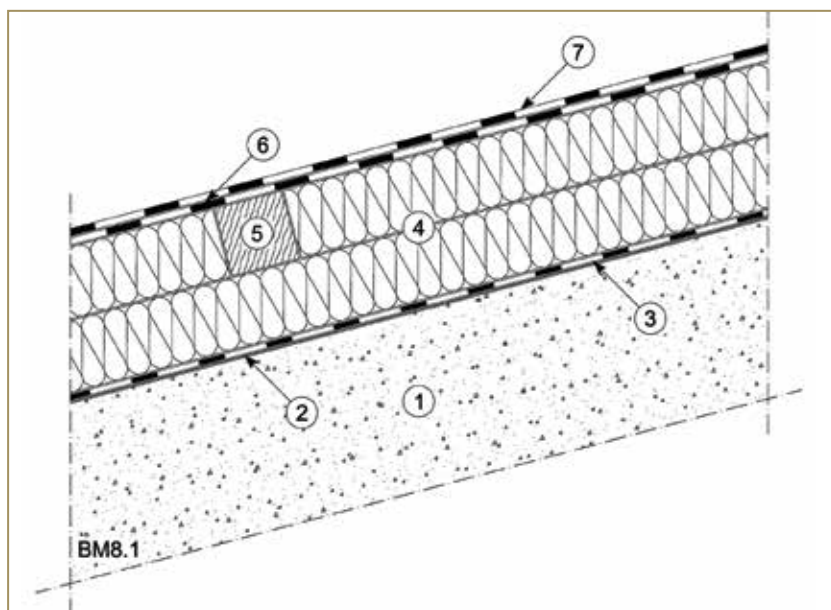
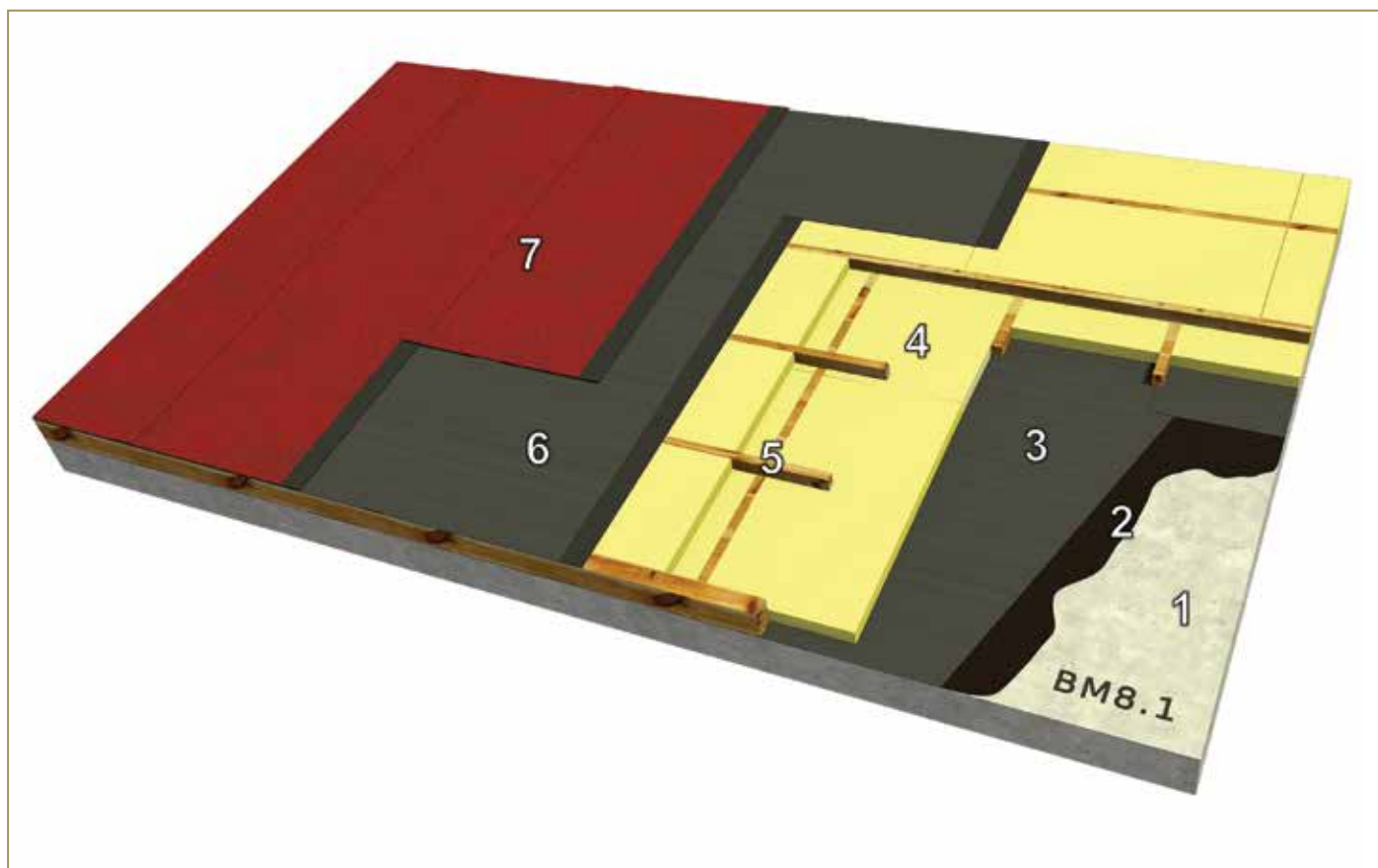

- ① Substrate/Roof deck
- ② Bituminous primer (for example **IDROPRIMER**)
- ③ Vapour barrier (for example **POLYVAP SA**)
- ④ Thermal insulation panel
- ⑤ Restraint wooden batten
- ⑥ Waterproofing bituminous membrane **ADESO**<sup>®</sup> (1<sup>st</sup> layer)
- ⑦ Waterproofing bituminous membrane **ADESO**<sup>®</sup> with mineral surface (2<sup>nd</sup> layer)

## 8.2.2 TILED ROOFS WITH MEMBRANE UNDERLAYS

On tiled roofs, where the tiles act as a discontinuous waterproofing layer, **ADESO**® self-adhesive membranes, applied in just one layer, have the function of providing a continuous waterproofing safety layer.

In compliance with the current regulations, tiles must be laid on appropriate battens/support components. Laying tiles directly on the bitumen membranes with mortar, glue or expanding foam is not allowed, since they do not guarantee adhesion of the various components and do not allow the correct micro-ventilation of the tiles themselves.

On sloping warm roofs, the insulating layer must be inserted after laying the vapour barrier between adequate containing battens. Before laying the tiles, a batten must be laid perpendicular to the eaves line, on which suitably spaced strips are fixed, used to anchor the tiles themselves.

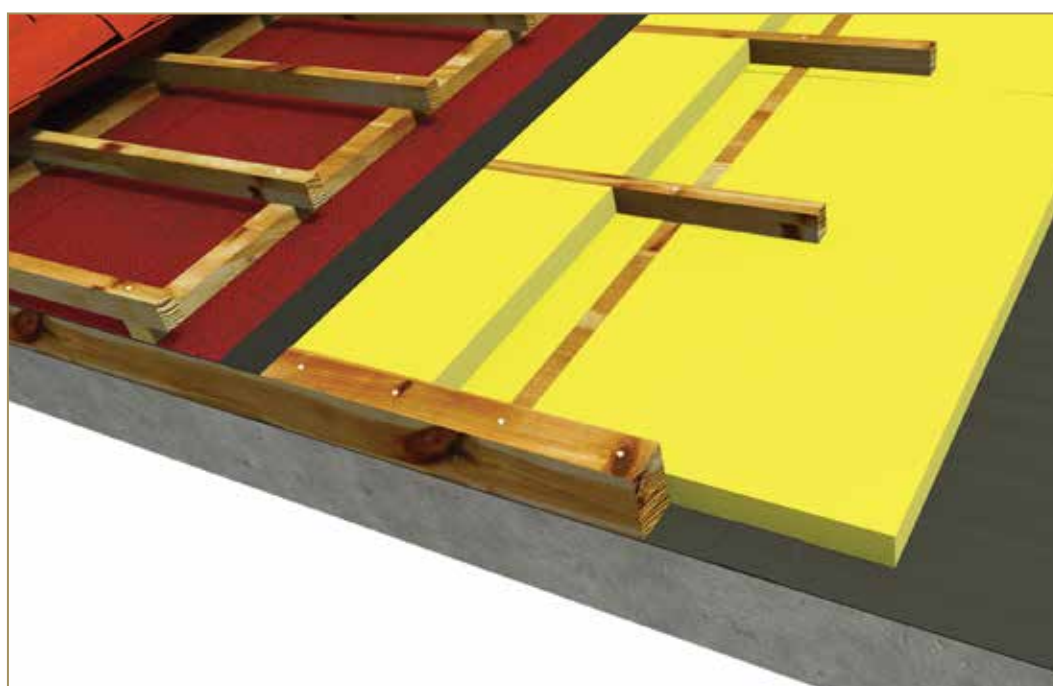

Figure 8.19: Laying the insulating panels between containing battens and layout of the tile anchoring battens.

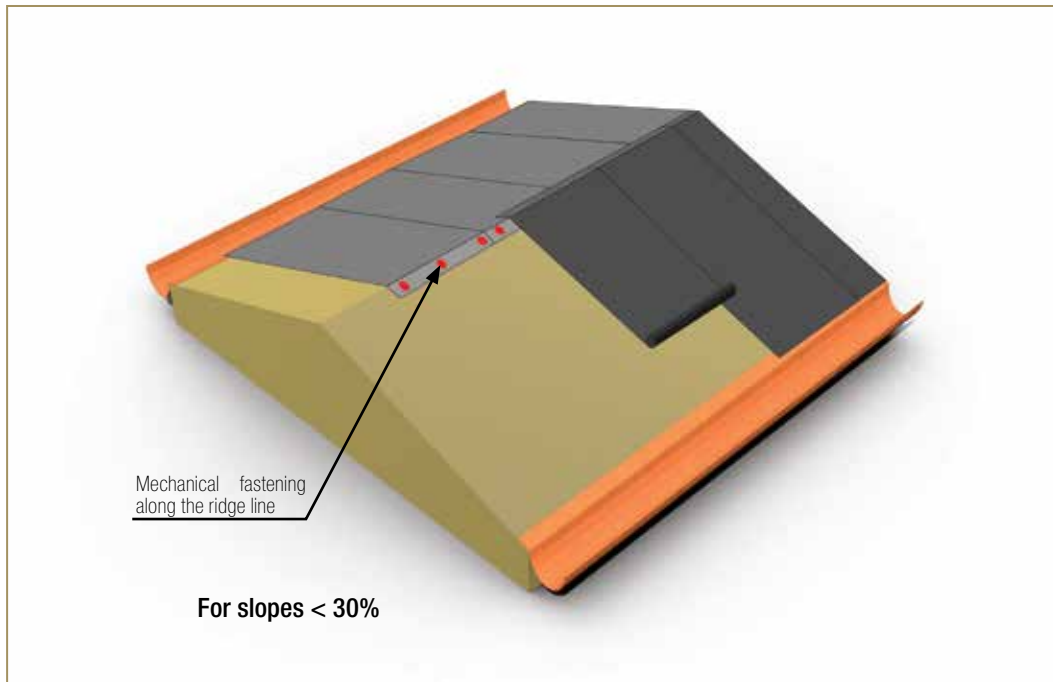

Figure 8.20: Layout and fixing of the membranes on roofs with < 30% slope (cold roof) and < 20% (warm roof)

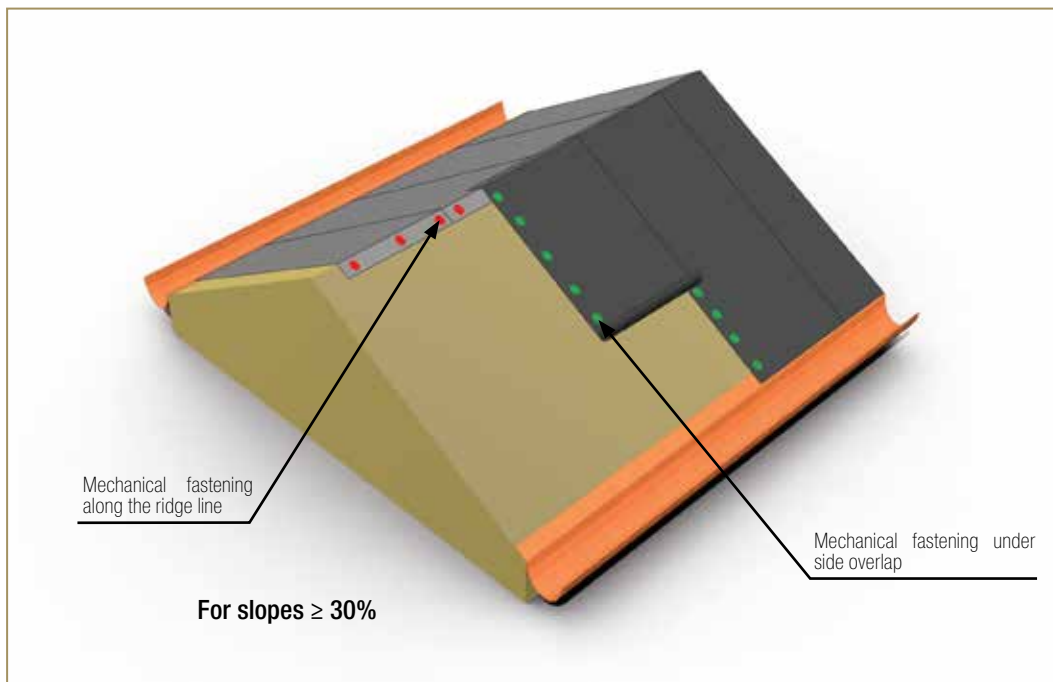

Figure 8.21: Layout and fixing of the membranes on roofs ≥ 30% slope (cold roof) and ≥ 20% (warm roof)



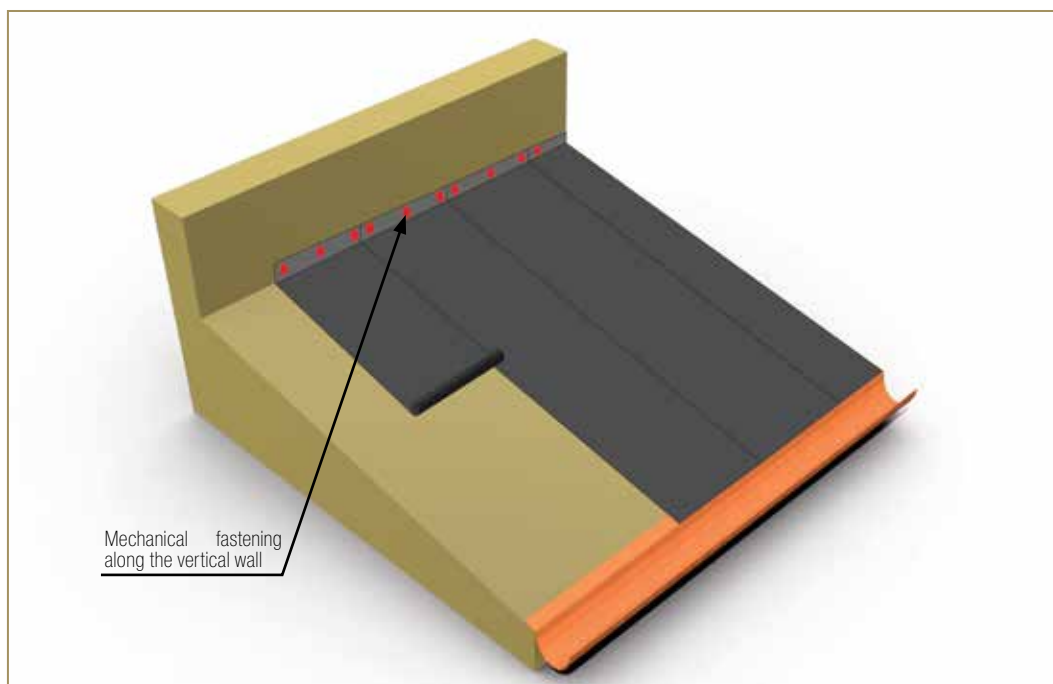
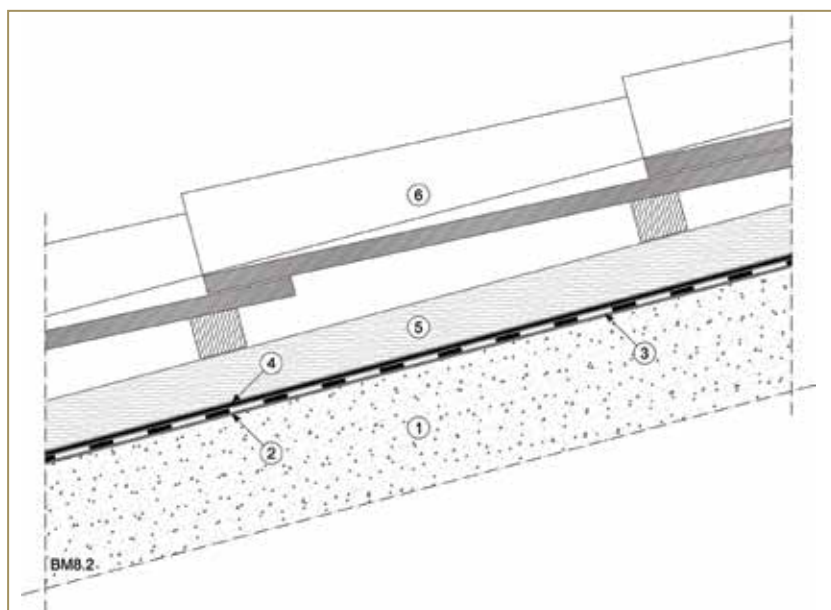
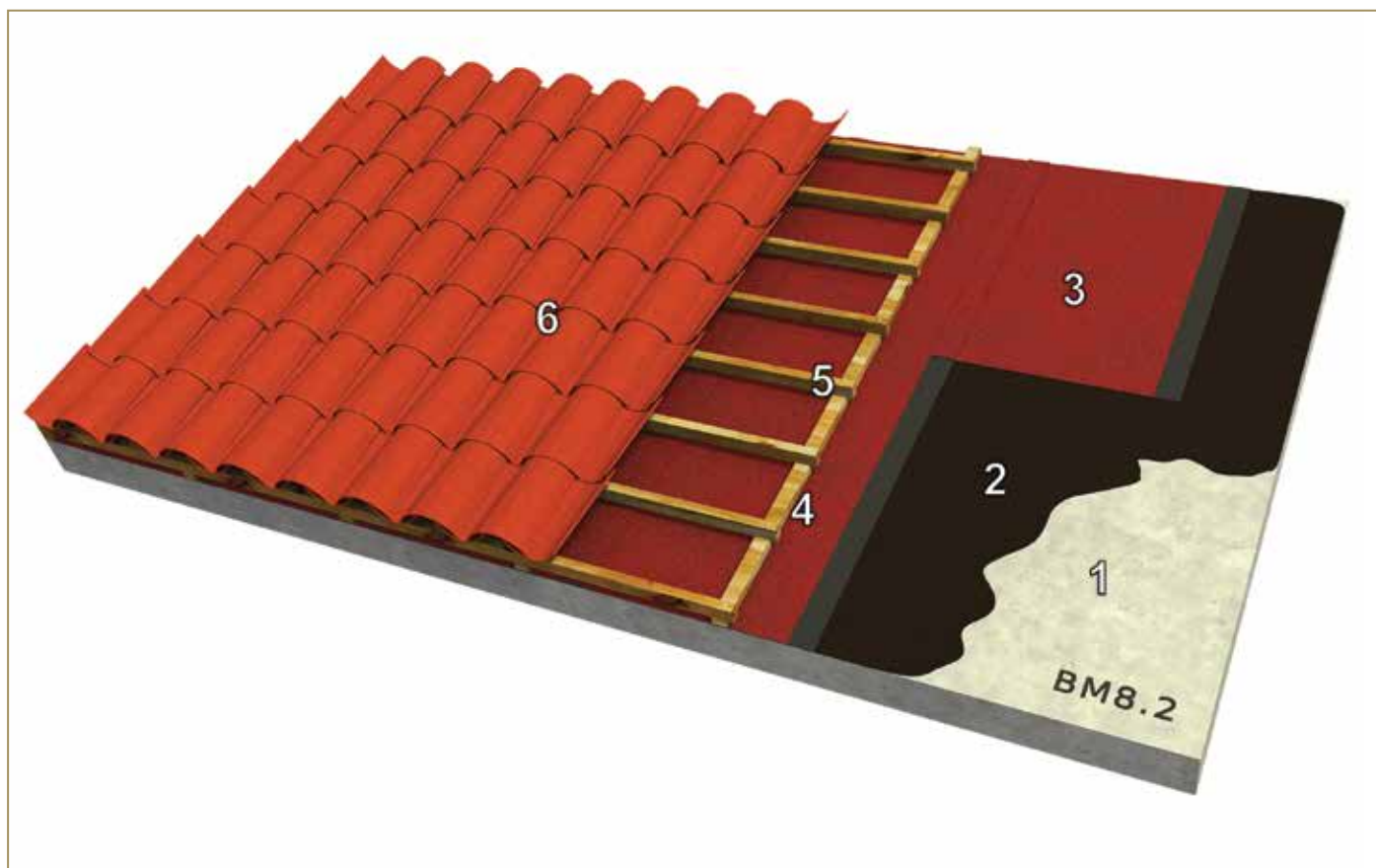

Figure 8.22: Layout and fixing of the membranes when there are connections between pitch and vertical wall



## BUILD-UP BM8.2 Sloped roof with tiles - Non insulated



- ① Substrate/Roof deck
- ② Bituminous primer (for example **IDROPRIMER**)
- ③ Waterproofing bituminous membrane **ADESO**<sup>®</sup> suitable for use under roof tiles
- ④ Sealing tape **POLYTAPE PE FOAM**
- ⑤ Wooden batten for anchorage of roof tiles
- ⑥ Roof tiles

## BUILD-UP BM8.3

### Sloped roof with tiles - Insulated

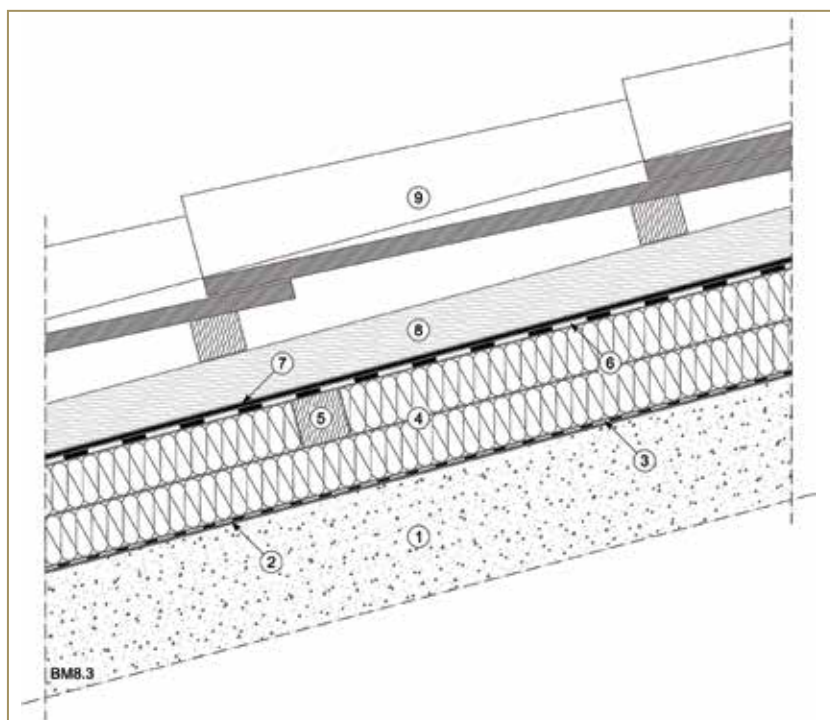
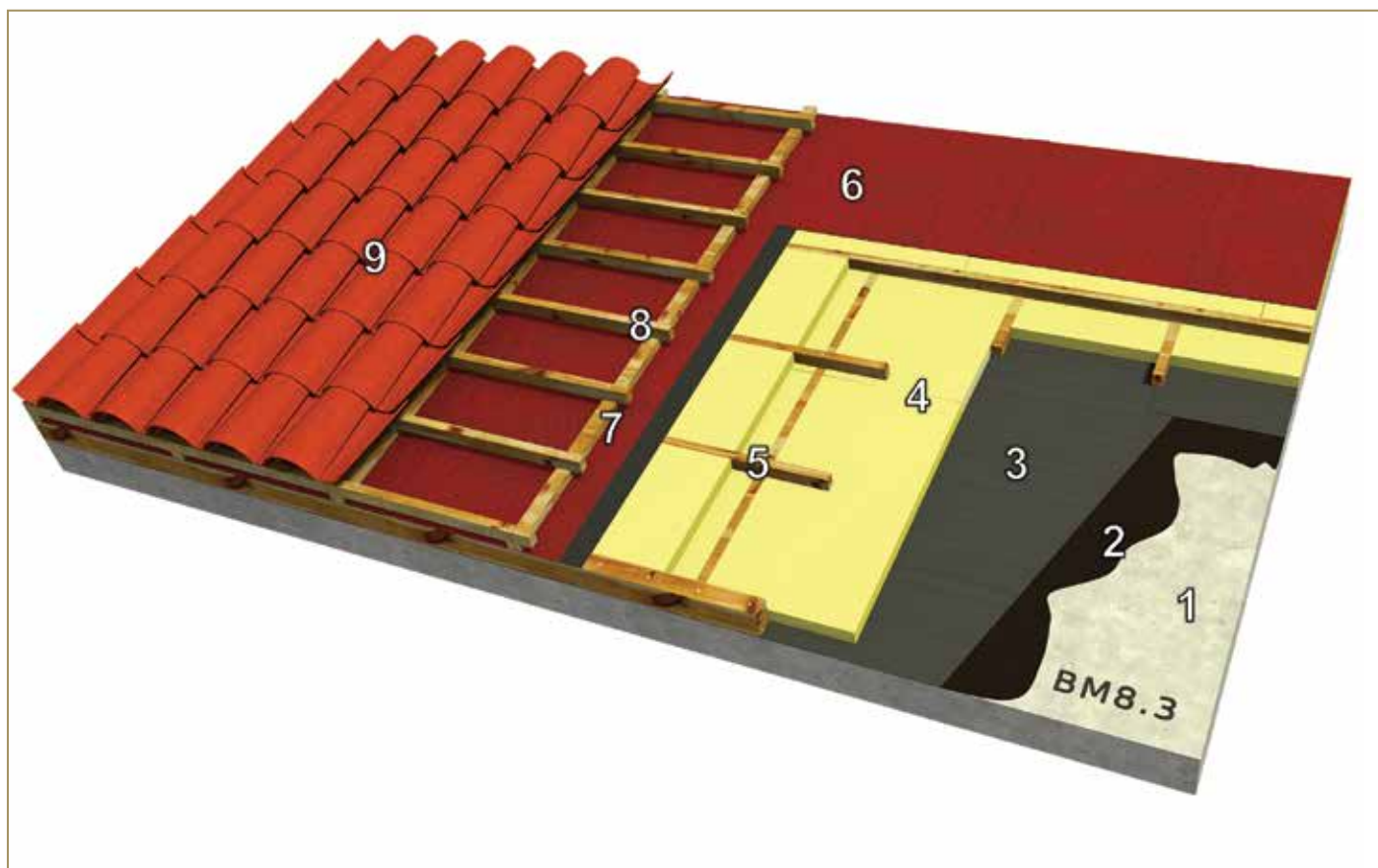

- ① Substrate/Roof deck
- ② Bituminous primer (for example **IDROPRIMER**)
- ③ Vapour barrier (for example **POLYVAP SA**)
- ④ Double layer of thermal insulation panel
- ⑤ Restraint wooden batten
- ⑥ Waterproofing bituminous membrane **ADESO**<sup>®</sup> suitable for use under roof tiles
- ⑦ Sealing tape **POLYTAPE PE FOAM**
- ⑧ Wooden batten for anchorage of roof tiles
- ⑨ Roof tiles

## BUILD-UP BM8.5

### Sloped roof with tiles - Insulated and ventilated

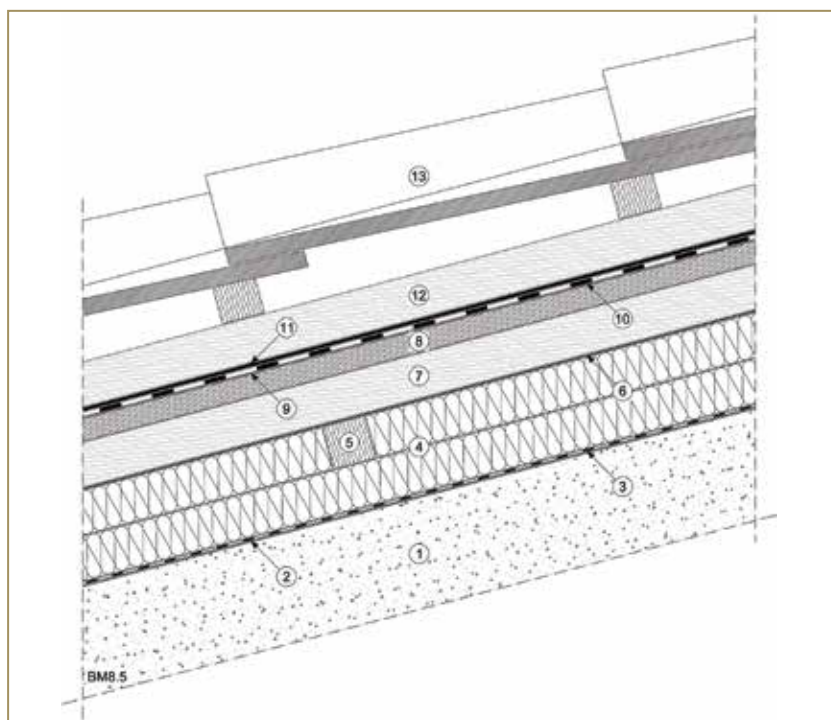
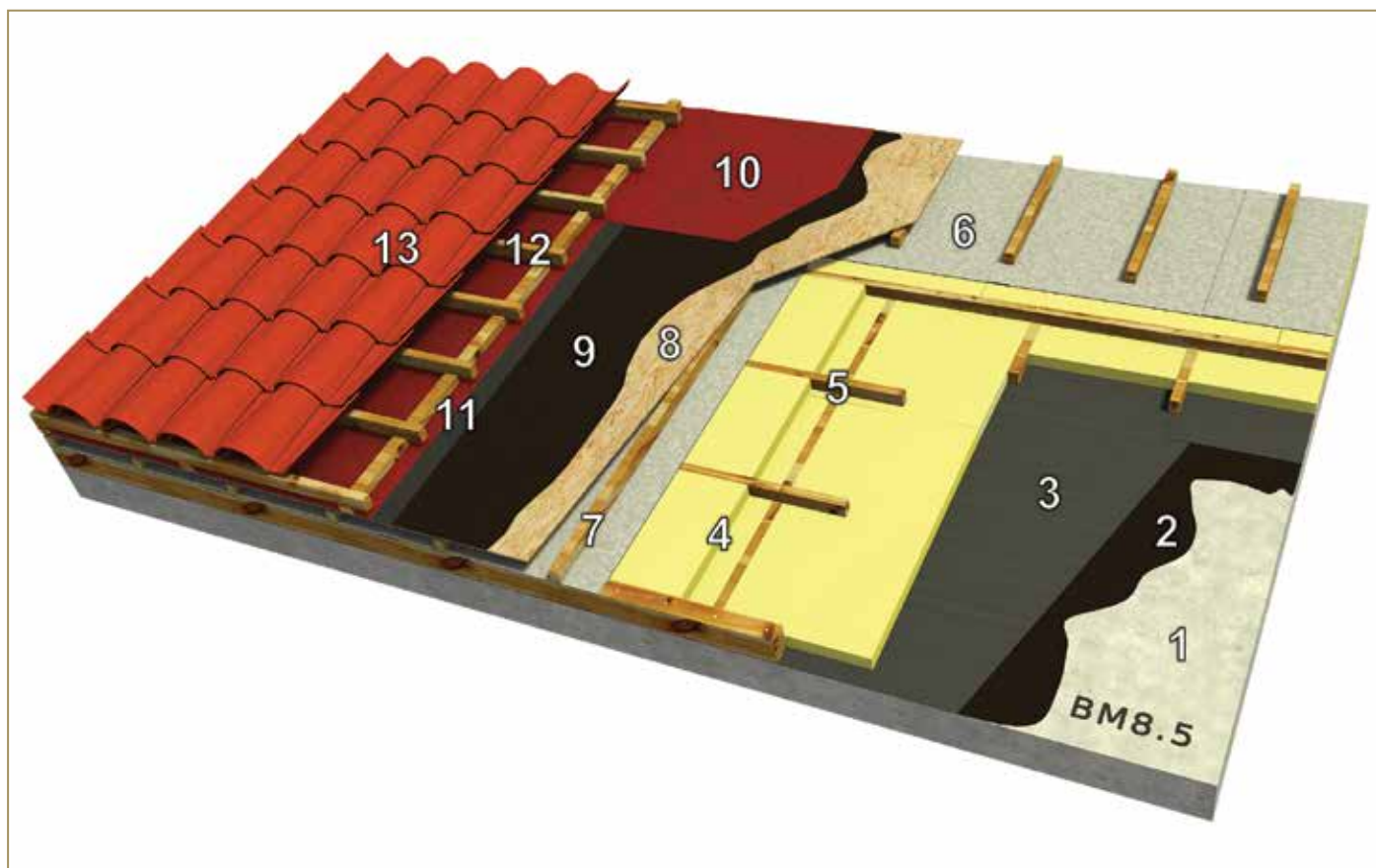

- ① Substrate/roof deck
- ② Bituminous primer (for example **IDROPRIMER**)
- ③ Vapour barrier (for example **POLYVAP SA**)
- ④ Double layer of thermal insulation panel
- ⑤ Restraint wooden batten
- ⑥ Highly breathable waterproofing underlay (for example **SILVERTEK 15 SEAL LAP**)
- ⑦ Secondary wooden batten for ventilation gap
- ⑧ OSB or PLYWOOD panels
- ⑨ Bituminous primer (for example **IDROPRIMER**)
- ⑩ Waterproofing bituminous membrane **ADESO**® suitable for use under roof tiles
- ⑪ Sealing tape **POLYTAPE PE FOAM**
- ⑫ Wooden batten for anchorage of roof tiles
- ⑬ Roof tiles

### 8.3 RETAINING WALLS

**ADESO**® membranes can be used to waterproof and protect underground structures from rising damp. However, they are unsuitable where groundwater is present. If thermal insulation is required, a two layer system should be used, otherwise a single layer system may be used.

Any excavation work must first of all be made safe, in compliance with all applicable health and safety requirements.

When damp-proofing underground structures from permeating water, allowances should be made where there is no waterproof connection between the base of the wall and the horizontal surface of the raft foundation, therefore, in order to prevent the water from rising behind the waterproof layer, and before the backfilling phase, a micro-perforated tube must be positioned which, when connected to soakaways, will adequately drain the structure.

If, during the casting process, release agents or additives have been used, the concrete walls must be power washed and the surface must also be carefully checked, in order to identify any metal components used as formwork spacers to ensure they have no sharp points or components that may crack or damage the waterproofing membrane.

After a thorough check, a bituminous primer can be applied by roller or Airless spray; water-based bituminous primers are preferred to solvent-based ones.

When the bituminous primer has dried (about 24 hours from application) and the surface preparation has been completed, the waterproof layer can be laid. The height of the wall should be taken in to account, with the membrane height not exceeding 2 m in length, as shown in the following drawings, this is to facilitate ease and accuracy of installation. (Figure 8.23).

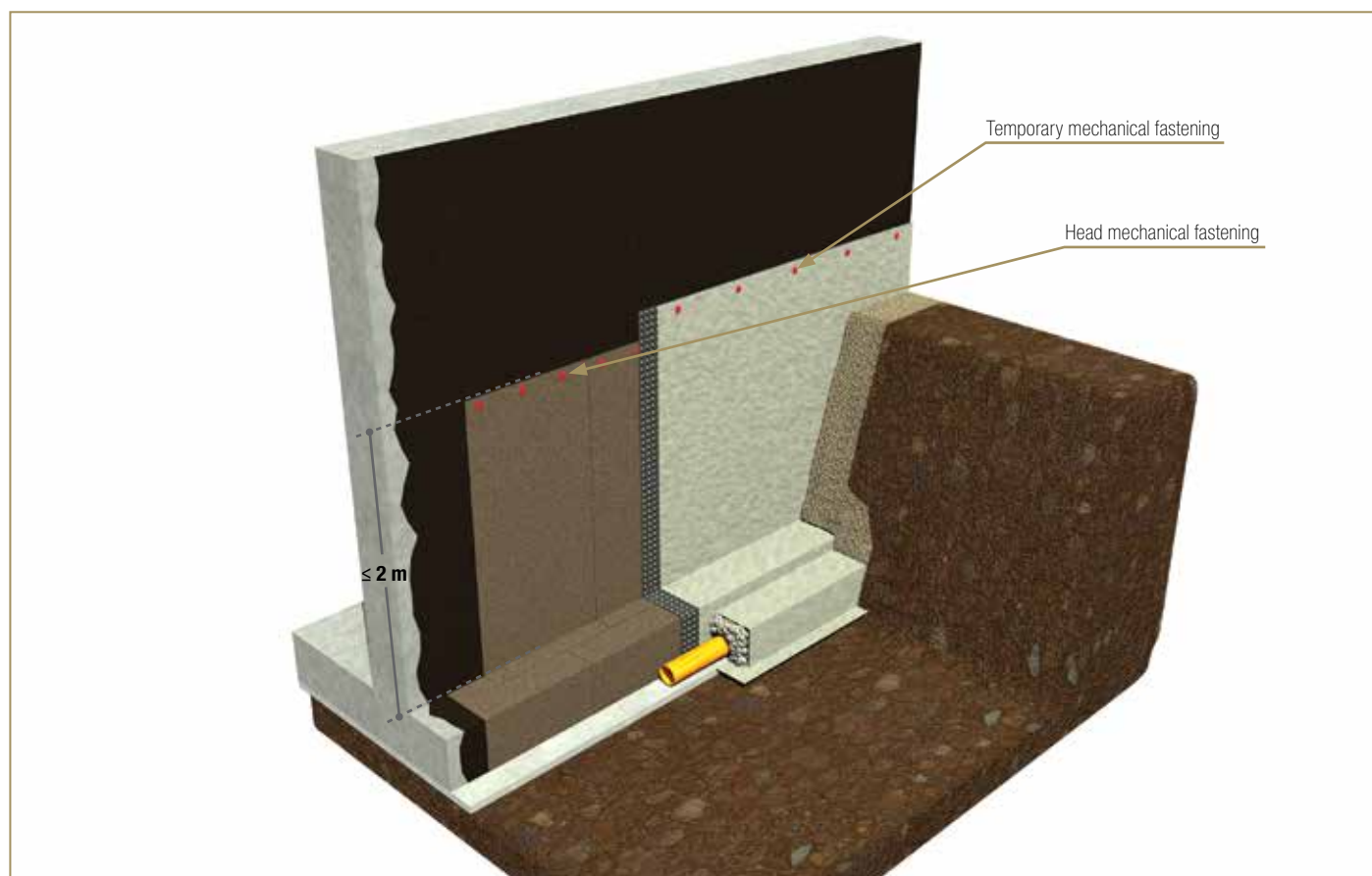

Figure 8.23: First waterproofing phase and associated accessories (first 2 m in height)



The membranes must be positioned and applied onto the wall removing the release mono-silicone film, mechanical fastening is required at the top of the roll in order to stabilize the sheet.

At the end of the works and before backfilling, the membranes must be secured using a metal profile, mechanically fixed to the surface and sealed at the top with POLYDETAIL MS or silicone glue. When the waterproofing layers have been installed, a protective and draining layer must be used (POLYFOND KIT DRAIN type), should be suitably laid on the membrane, before backfilling and closing the excavation.

The waterproofing layer must always extend up by at least 15 cm above the finished level of the ground works and be protected at the top by a sealed metal profile and the drainage protective system; this will protect it from UV rays and any mechanical damage (Figure 8.24).

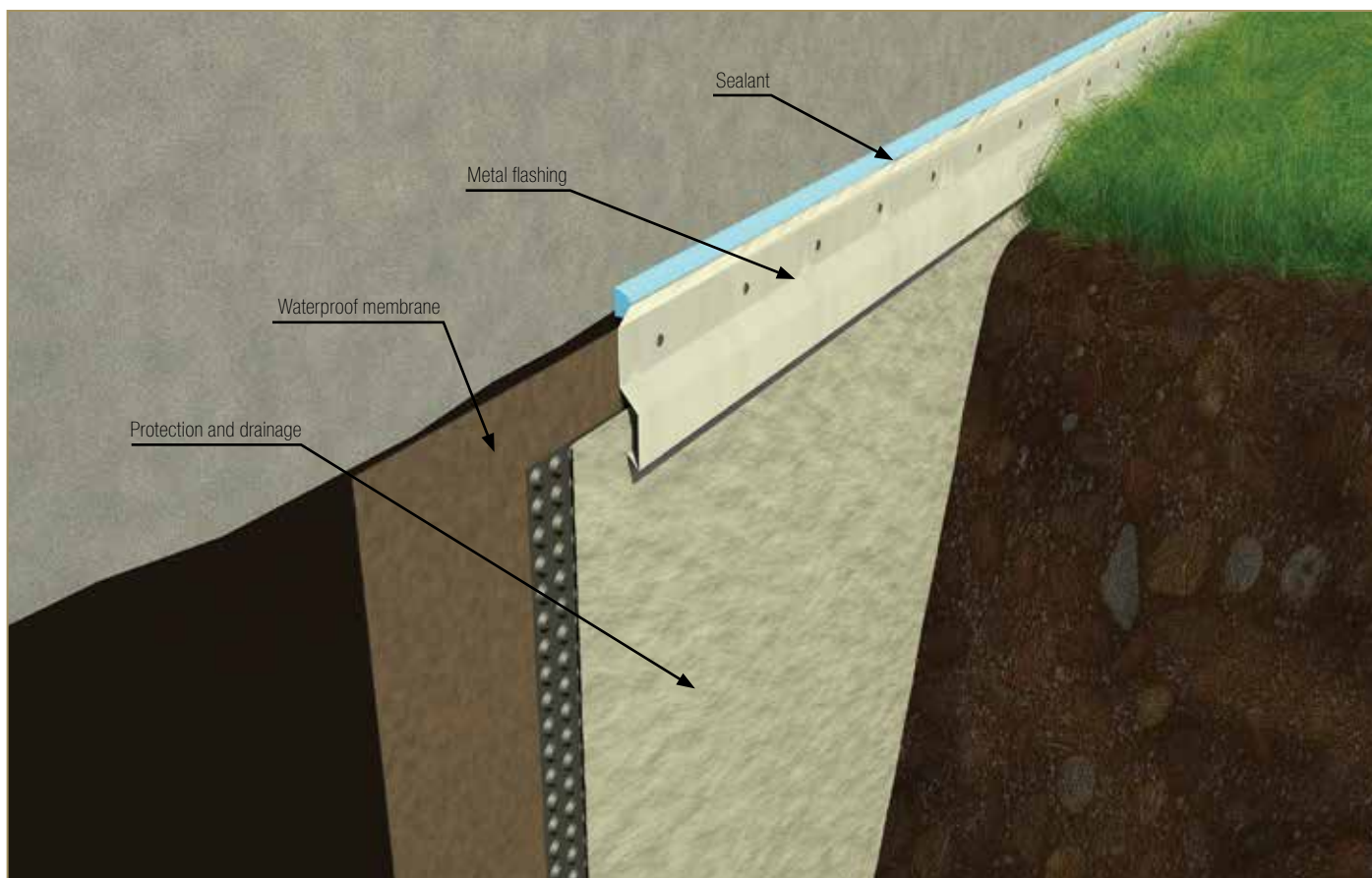
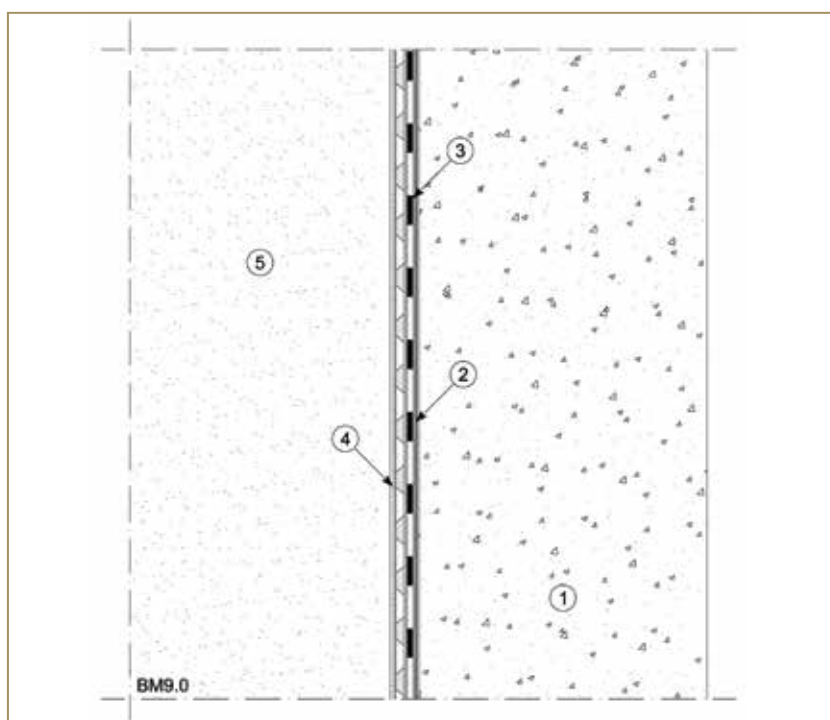
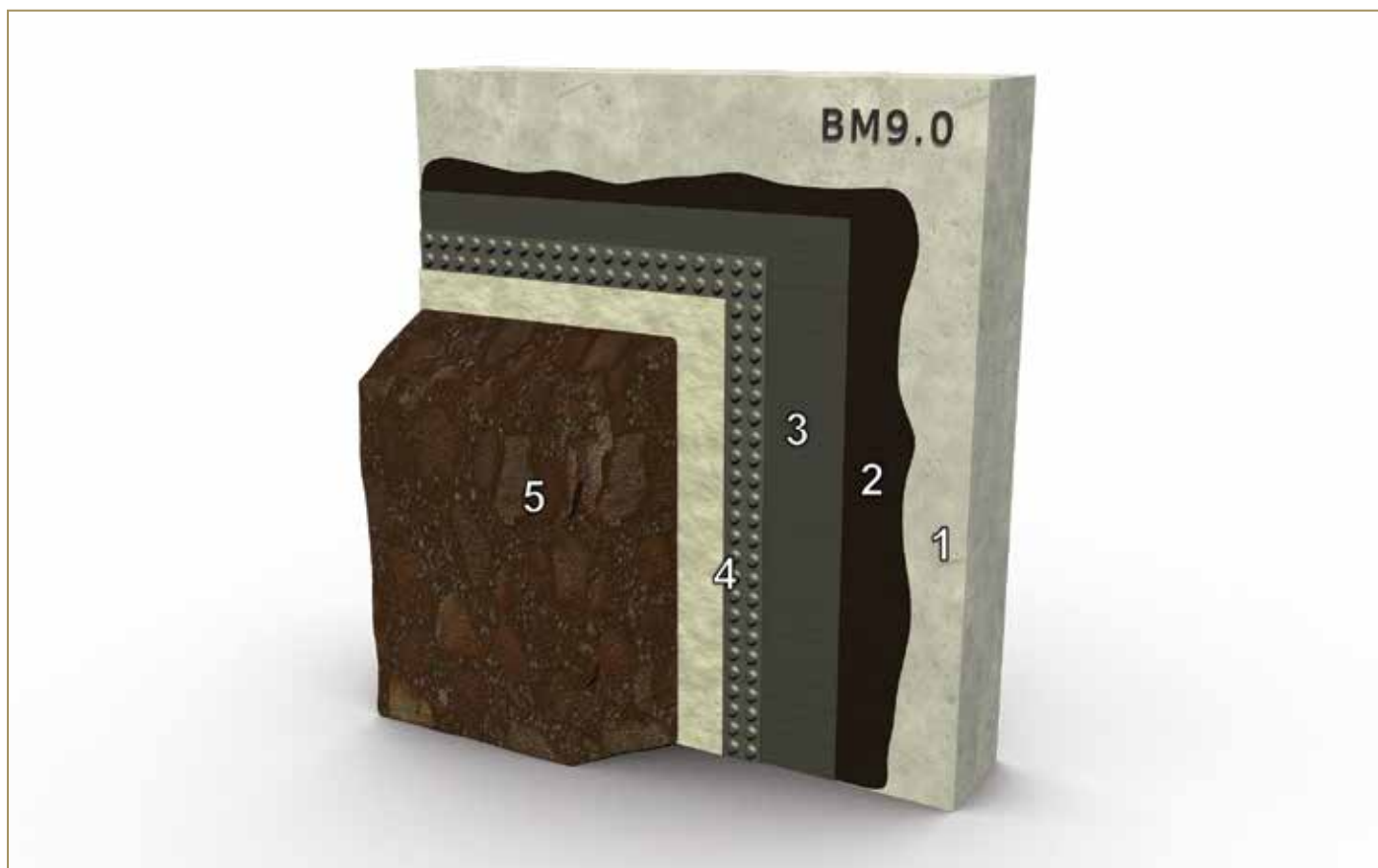

Figure 8.24: Detail of the closure and seal

## BUILD-UP BM9.0 Retaining wall - Single layer



- ① Perimeter foundation wall
- ② Bituminous primer (for example **IDROPRIMER**)
- ③ Waterproofing bituminous membrane **ADESO**<sup>®</sup> suitable for use against rising damp
- ④ Protective and drainage layer **POLYFOND KIT DRAIN**
- ⑤ Refill with soil

## BUILD-UP BM9.1 Retaining wall - Double layer with insulation

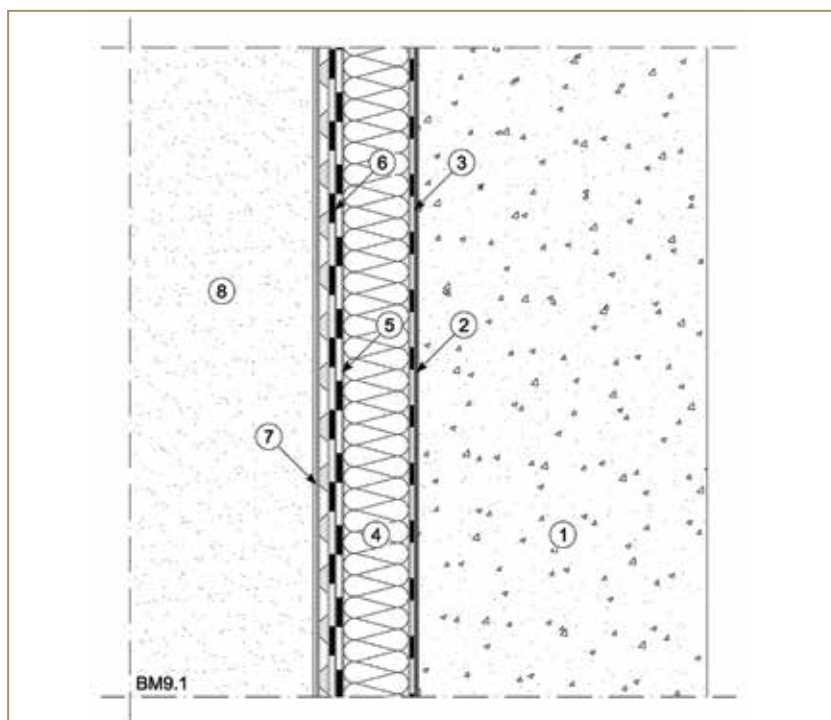
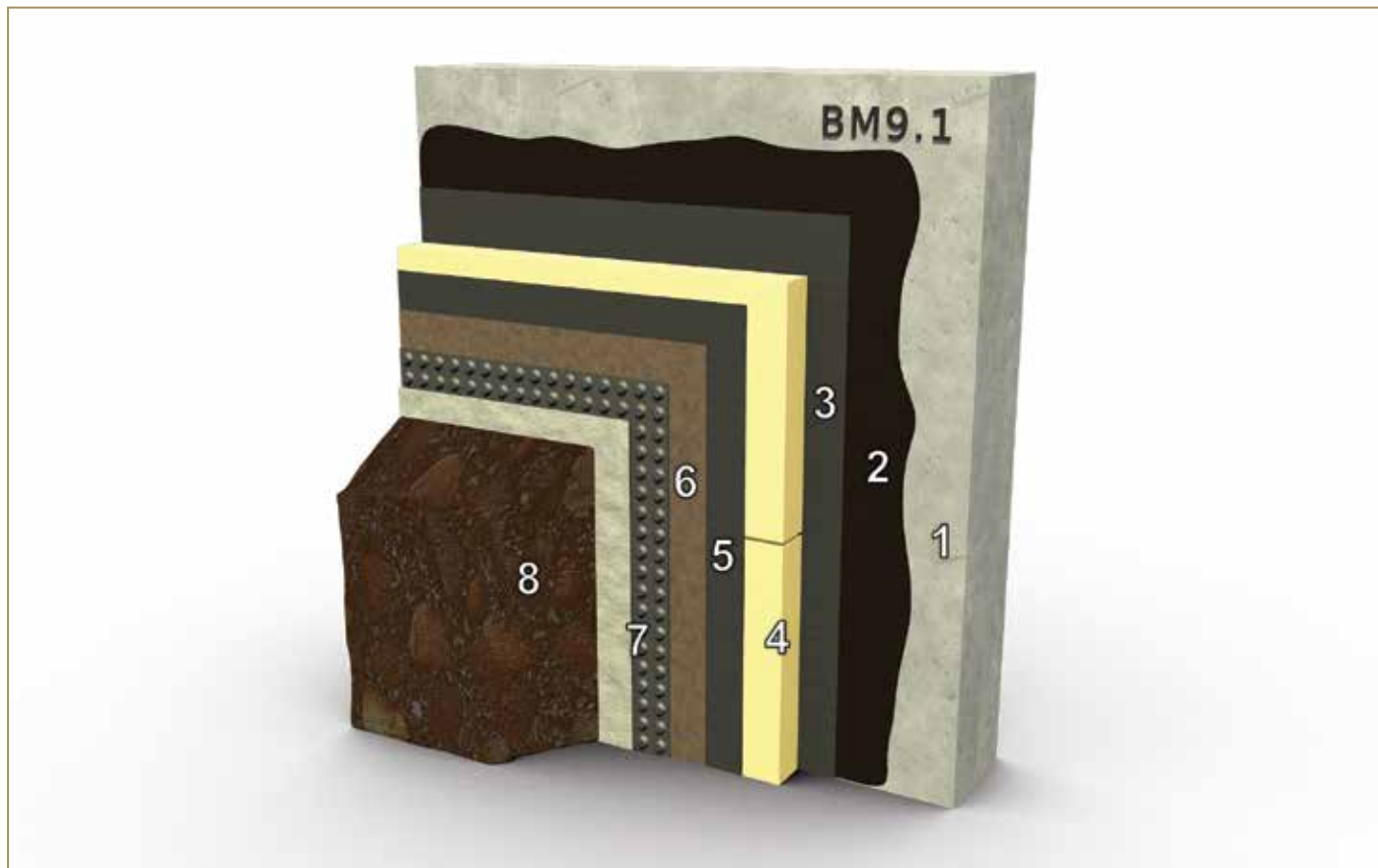

- ① Perimeter foundation wall
- ② Bituminous primer (for example **IDROPRIMER**)
- ③ Vapour barrier (for example **POLYVAP SA**)
- ④ Thermal insulation panels
- ⑤ Waterproofing bituminous membrane **ADESO**<sup>®</sup> suitable for use against rising damp (1<sup>st</sup> layer)
- ⑥ Waterproofing bituminous membrane **ADESO**<sup>®</sup> suitable for use against rising damp (2<sup>nd</sup> layer)
- ⑦ Protective and drainage layer **POLYFOND KIT DRAIN**
- ⑧ Refill with soil



## 9. INSTALLATION OF CONSTRUCTION DETAILS

### INTERNAL CORNER AND PREPARATION OF THE VERTICAL UP-TURN ON MINERAL GRANULE SURFACED MEMBRANES



Figure 9.1: Preparation of the internal corner



Figure 9.2: Up-turn vertical welding



Figure 9.3: Flat welding



Figure 9.4: Cutting a 20x20 cm patch of membrane



Figure 9.5: Folding the patch of membrane into 4 parts



Figure 9.6: Rolling to mark the 4 corner portions

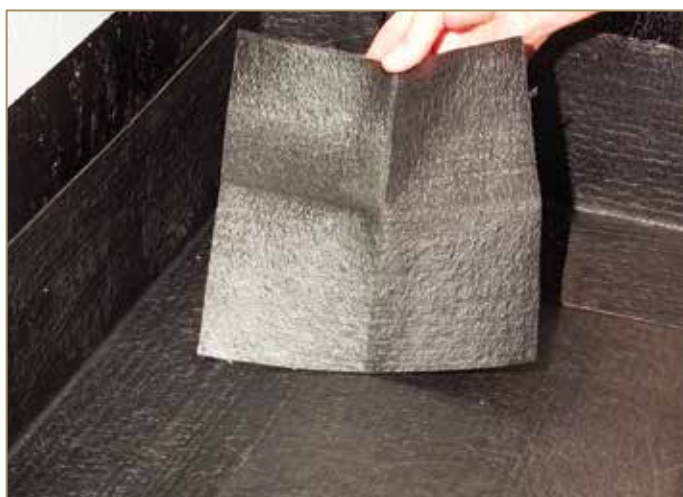

Figure 9.7: Patch of shaped membrane ready to close the corner



Figure 9.8: Application and gluing of the patch on the vertical wall



Figure 9.9: Removing the protective film



Figure 9.10: Horizontal gluing and rolling



Figure 9.11: Hermetically closing and welding the corner



Figure 9.12: Finished corner



Figure 9.13: Preparing the vertical up-turn on granule surfaced membrane



Figure 9.14: Partially removing the protective film



Figure 9.15: Positioning and gluing on the vertical up-turn



Figure 9.16: Rolling the top part



Figure 9.17: Removing the protective film



Figure 9.18: Welding the overlap on the flat surface



Figure 9.19: Preparing the vertical up-turn on the adjacent wall



Figure 9.20: Rolling the vertical detail



Figure 9.21: Total removal of the release film



Figure 9.22: Vertical up-turn adhered to the wall



Figure 9.23: Welding the overlap on the flat surface



Figure 9.24: Preparing the shaped patch of membrane for the corner



Figure 9.25: First gluing phase of the membrane patch



Figure 9.26: Welding the patch on the vertical wall



Figure 9.27: Welding the patch overlap on the flat surface



Figure 9.28: Hermetically closing and welding the corner



Figure 9.29: Corner and equipment used



Figure 9.30: Overlap of two adjacent vertical up-turn



Figure 9.31: Welding the overlap on the flat surface



Figure 9.32: Up-turn at vertical welding



Figure 9.33: Fixing the termination profile to the wall



Figure 9.34: Sealing using POLYDETAIL MS



Figure 9.35: Completed internal corner with profile and studs

## EXTERNAL CORNER AND PROTRUDING STRUCTURES

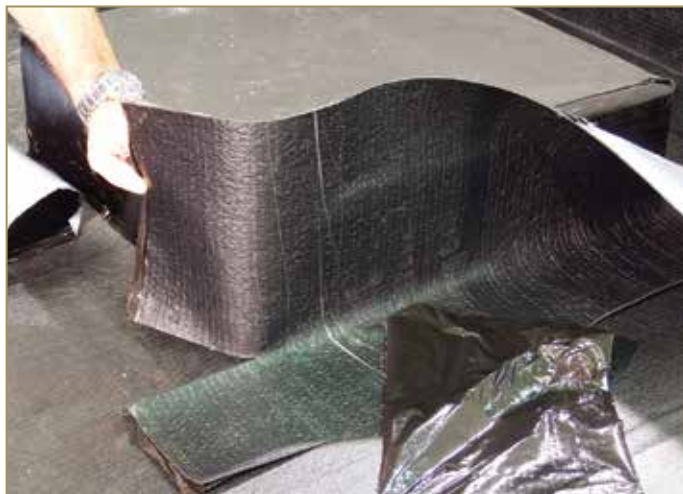

Figure 9.36: Preparing the vertical up-turn of the first waterproof layer



Figure 9.37: Welding the overlap on the flat surface



Figure 9.38: Folding the membrane on the upper edge

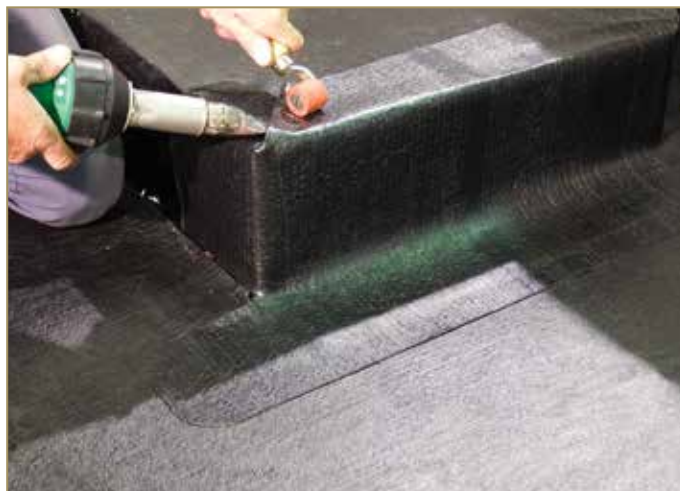

Figure 9.39: Hermetically closing and welding the upper corner

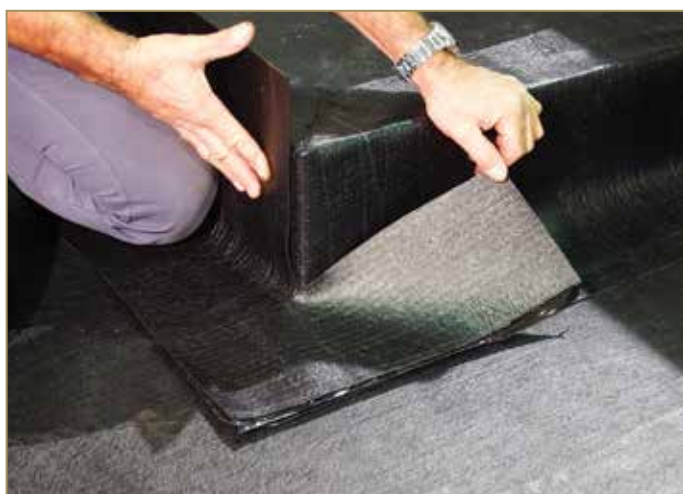

Figure 9.40: Making the part of vertical up-turn adjacent to the first one



Figure 9.41: Cut at 45° of the overlapping part on the flat surface





Figure 9.42: Gluing on the vertical wall of the up-turn



Figure 9.43: Up-turn at vertical welding

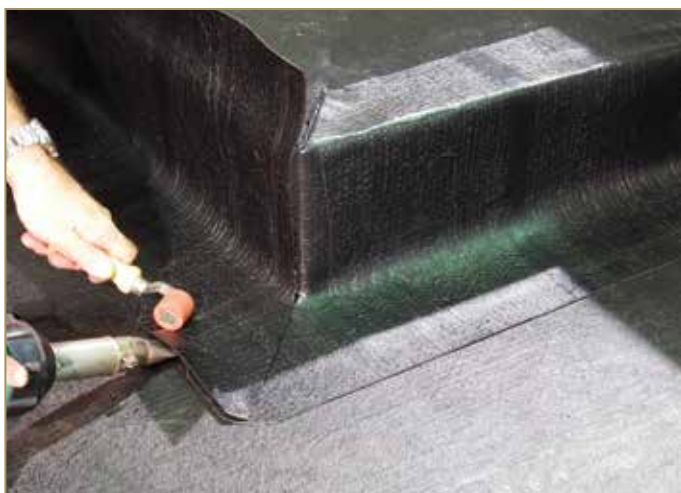

Figure 9.44: Welding the overlap on the flat surface



Figure 9.45: Welding the upper corner



Figure 9.46: Preparing the shaped patch of membrane for the corner



Figure 9.47: Positioning and gluing the closing patch



Figure 9.48: Welding the patch on the vertical wall



Figure 9.49: Welding the patch on the flat surface



Figure 9.50: Preparing the top of the protruding structure



Figure 9.51: Closing weld of the top of the protruding structure



Figure 9.52: Preparing the vertical up-turn of the second waterproof layer with slate chipping finish



Figure 9.53: Gluing and rolling the vertical up-turn

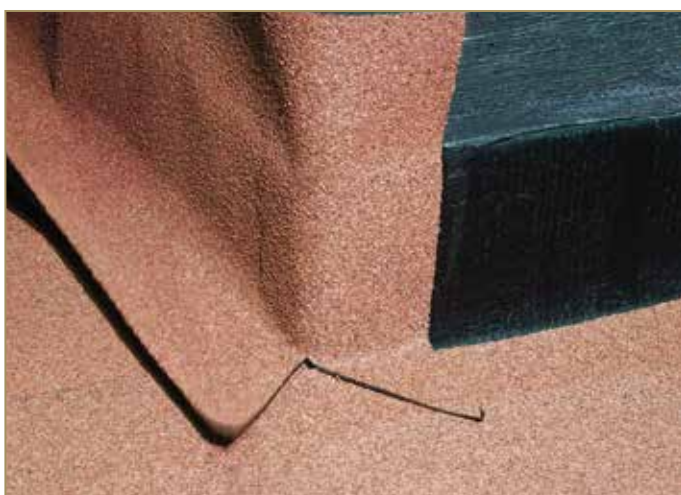

Figure 9.54: Cutting at 45° and folding the up-turn on the corner



Figure 9.55: Welding the overlap on the flat surface



Figure 9.56: Trimming and cutting off the excess membrane (triangle)



Figure 9.57: Folding the membrane on the upper edge



Figure 9.58: Hermetically closing and welding the corner



Figure 9.59: Preparing and gluing the adjacent vertical up-turn



Figure 9.60: Cut at 45° of the overlapping part on the surface



Figure 9.61: Welding the overlap on the flat surface



Figure 9.62: Welding the vertical overlap



Figure 9.63: Welding the upper corner

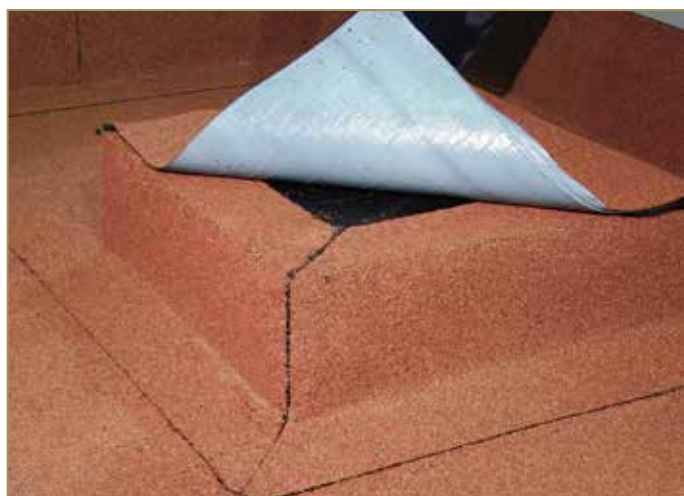

Figure 9.64: Preparing the base end closure



Figure 9.65: Welding the upper edge



Figure 9.66: Preparing the closing membrane patch



Figure 9.67: Welding the patch



Figure 9.68: Finished external corners



## DRAIN OUTLETS



Figure 9.69: Preparing the membrane to place under the outlet flange for vapour barrier 50x50 cm



Figure 9.70: Positioning the membrane and removing the protective film

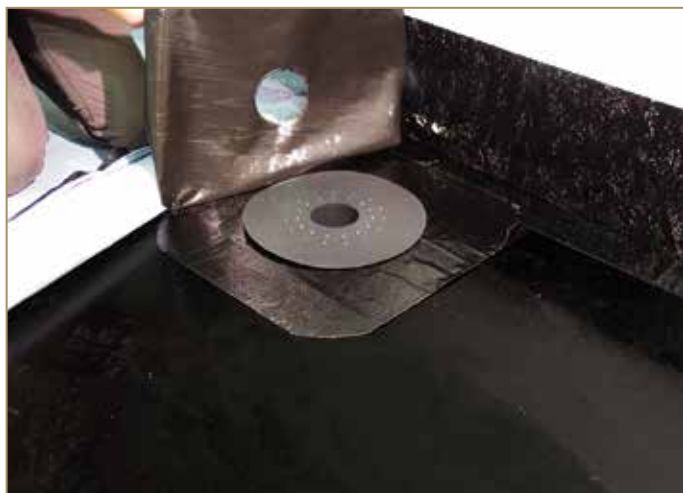

Figure 9.71: Partial removal of the protective film and outlet positioning



Figure 9.72: Replacing the protective film and rolling to glue outlet



Figure 9.73: Positioning the **ADESO**® vapour barrier and rolling



Figure 9.74: Removing the protective film and gluing the panel



Figure 9.75: Positioning the membrane under the outlet

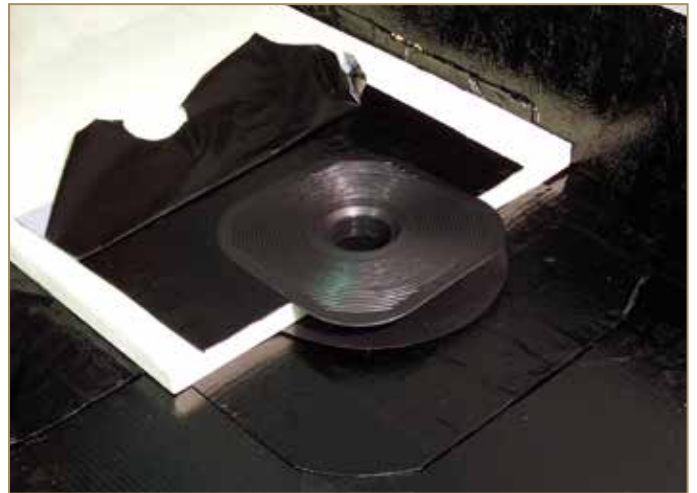

Figure 9.76: Partial removal of the protective film and outlet positioning



Figure 9.77: Replacing the protective film and rolling to glue outlet



Figure 9.78: Removing the protective film



Figure 9.79: Positioning the first waterproof layer

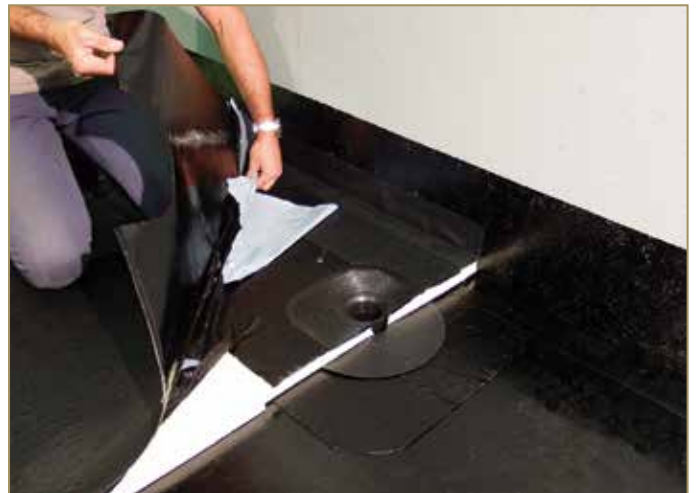

Figure 9.80: Removing the protective film and gluing the first layer



Figure 9.81: Membrane gluing and rolling



Figure 9.82: Closing weld of the first layer on outlet

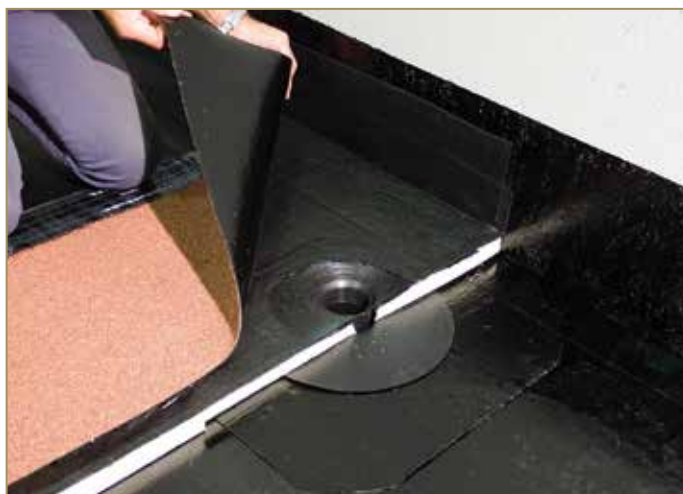

Figure 9.83: Laying the second waterproof layer with slate chipping finish



Figure 9.84: Rolling and gluing on the flat surface



Figure 9.85: Closing weld of the second layer on outlet

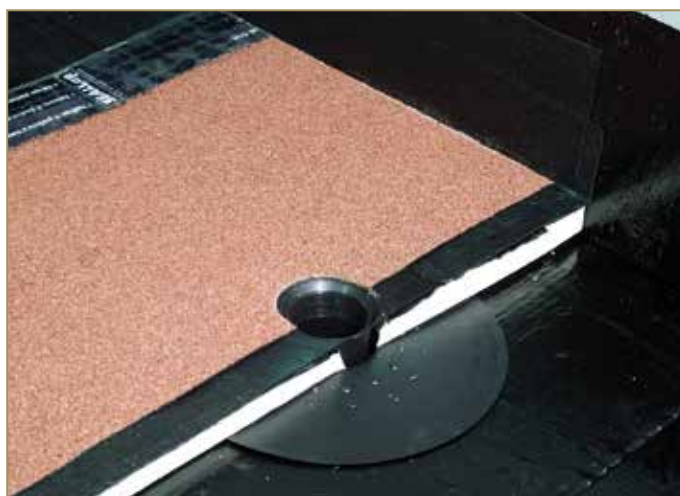

Figure 9.86: Finished waterproofing of the drain outlet

**NOTE:** the photos show the assembly of the layers with the fitting of a part of the drain outlet. However, as a thin insulating panel was used for illustration purposes, it was not possible to create a 50x50 cm tray, which would normally be incorporated improve drainage.



## TUBE AND VENT PIPE



Figure 9.87: Positioning and cutting the first waterproof layer



Figure 9.88: Removing the protective film and gluing the first layer



Figure 9.89: Laying the second roll and making the side overlap



Figure 9.90: Removing the protective film and gluing the second waterproof layer



Figure 9.91: Positioning the adjacent membrane and preparing the overlap at the beginning of the roll



Figure 9.92: Removing the protective films and gluing the membrane

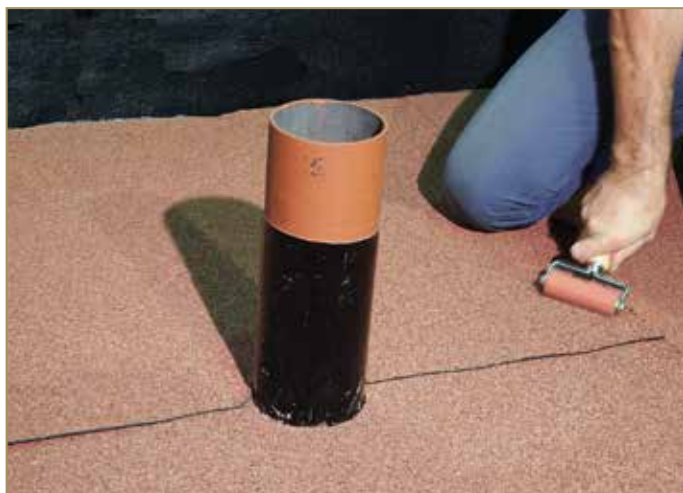

Figure 9.93: Rolling the overlaps



Figure 9.94: Closing weld of the overlap at the beginning of the roll



Figure 9.95: Preparing the elements to line the tube



Figure 9.96: Gluing the vertical up-turn on the tube



Figure 9.97: Welding and rolling the up-turn foot



Figure 9.98: Welding the vertical part



Figure 9.99: Welding the overlap on the vertical tube



Figure 9.100: Positioning the covering patch



Figure 9.101: Welding the covering patch on the flat surface



Figure 9.102: Positioning the closing patch



Figure 9.103: Closing weld of the patch cut



Figure 9.104: Sealing the tube base connection with POLYDETAIL MS



Figure 9.105: Levelling the POLYDETAIL MS



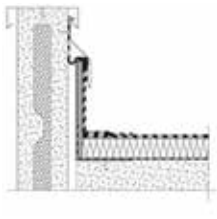
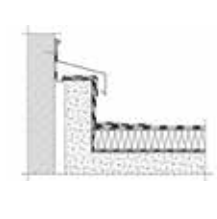
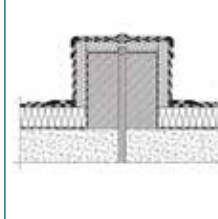
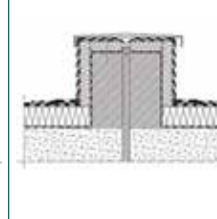
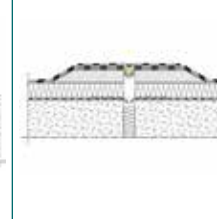
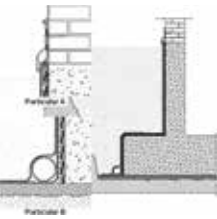



Figure 9.106: Top seal and aesthetic finish of the seal with slate chippings



# ADDENDUM

## FINISHING ELEMENTS AND DETAILS: TECHNICAL DRAWINGS

ROOF PARAPET					
Drawing B-0123 - Pag. II	Drawing B-0135 - Pag. III				
WALL CONNECTION					
Drawing B-0211 - Pag. IV					
SKYLIGHT CONNECTION					
Drawing B-0311 - Pag. V	Drawing B-0315 - Pag. VI				
ROOF OUTLET					
Drawing B-0403 - Pag. VII	Drawing B-0405 - Pag. VIII				
PIPE CONNECTION					
Drawing B-0500 - Pag. IX	Drawing B-0513 - Pag. X				

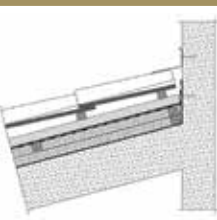
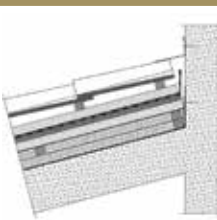
EXPANSION JOINT					
					
Drawing B-0603 - Pag. XI	Drawing B-0607 - Pag. XII	Drawing B-0608 - Pag. XIII	Drawing B-0609 - Pag. XIV	Drawing B-0610 - Pag. XV	Drawing B-0611 - Pag. XVI
FOUNDATION WALL					
					
Drawing B-0902 - Pag. XVII					
RIDGE OF SLOPED ROOF					
					
Drawing B-1112 - Pag. XIX	Drawing B-1113 - Pag. XX				
EAVE OF SLOPED ROOF					
					
Drawing B-1114 - Pag. XXII	Drawing B-1115 - Pag. XXIII				
WALL CONNECTION ON SLOPED ROOF					
					
Drawing B-1116 - Pag. XXIV	Drawing B-1117 - Pag. XXV				

## Drawing B-0123 - Roof parapet

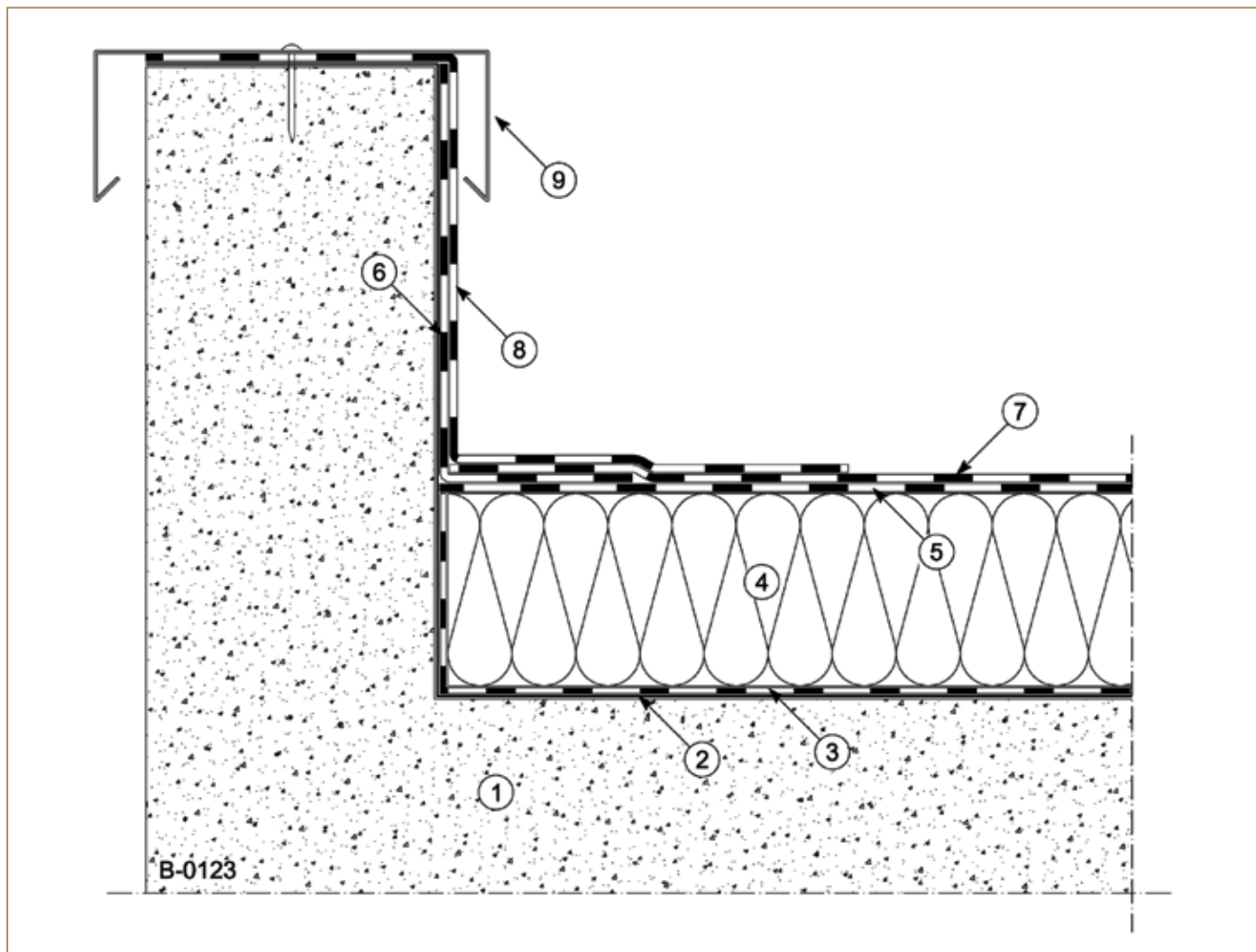

- ① Substrate/roof deck
- ② Bituminous primer (for example **IDROPRIMER**)
- ③ Vapour barrier (for example **POLYVAP SA**)
- ④ Thermal insulation panel
- ⑤ 1<sup>st</sup> waterproofing layer, **ADESO**® waterproofing membrane
- ⑥ 1<sup>st</sup> waterproofing layer for vertical up-turn, **ADESO**® waterproofing membrane
- ⑦ 2<sup>nd</sup> Waterproofing layer, **ADESO**® mineral surfaced waterproofing membrane
- ⑧ 2<sup>nd</sup> Waterproofing layer for vertical up-turn, **ADESO**® mineral surfaced waterproofing membrane
- ⑨ Metal flashing



## Drawing B-0135 - Roof parapet

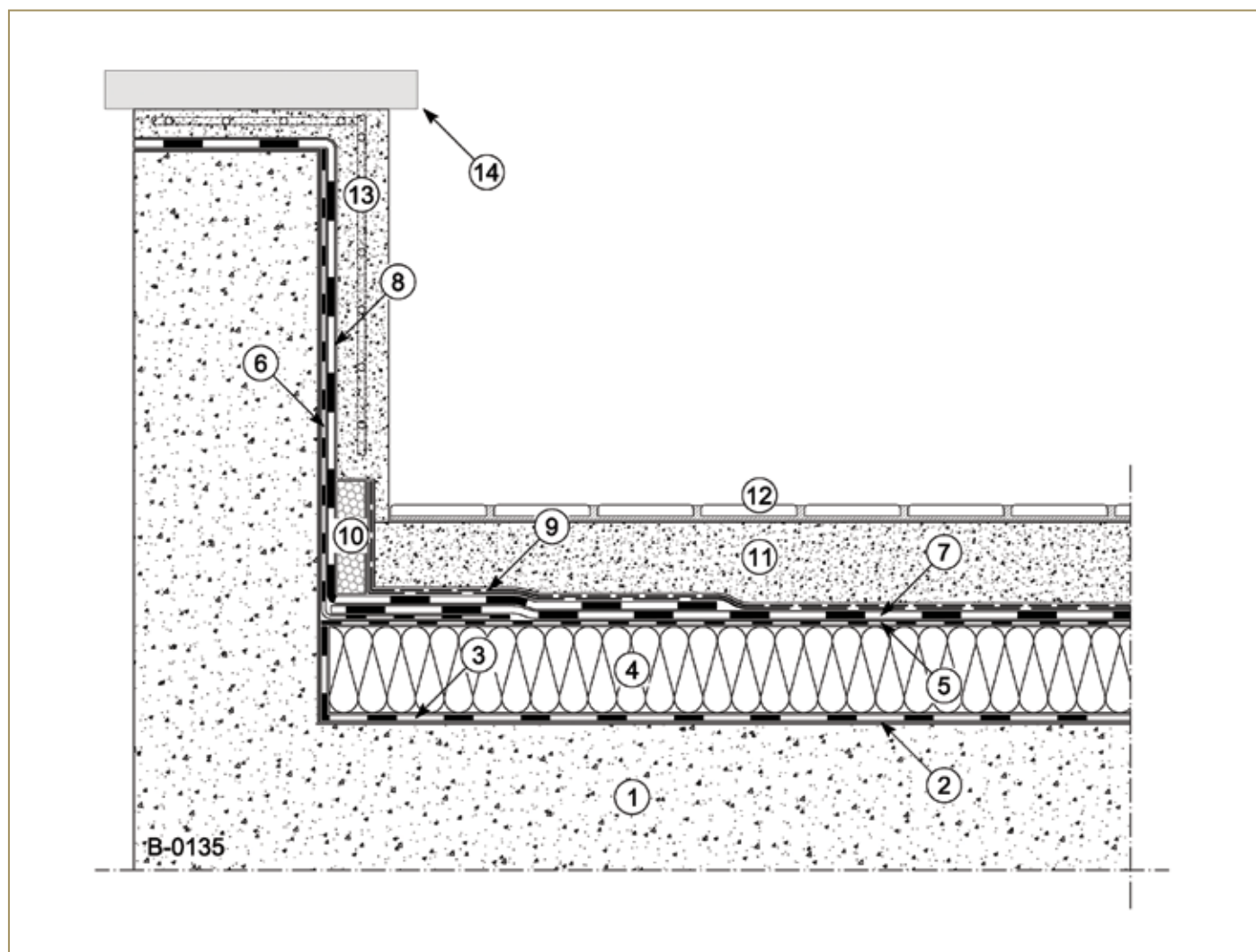

- ① Substrate/roof deck
- ② Bituminous primer (for example **IDROPRIMER**)
- ③ Vapour barrier (for example **POLYVAP SA**)
- ④ Thermal insulation panel
- ⑤ **ADESO**® waterproofing membrane (protective layer anti-flame)
- ⑥ **ADESO**® waterproofing membrane for vertical up-turn (protective layer anti-flame)
- ⑦ **POLYGLASS** waterproofing membrane, torch applied (top layer) \*
- ⑧ **POLYGLASS** waterproofing membrane torch applied at vertical up-turn (top layer) \*
- ⑨ Double separation layer in LDPE **MAPEPLAN PE macro-perforated** + **MAPEPLAN PE micro-perforated**
- ⑩ Shock absorber with expanded element
- ⑪ Protective screed with reinforced concrete
- ⑫ Paving tiles
- ⑬ Vertical up-turn protection with mesh and plaster
- ⑭ Finishing element

\* Traditional waterproofing membrane applied by torch, for single ply use.

## Drawing B-0211 - Wall connection

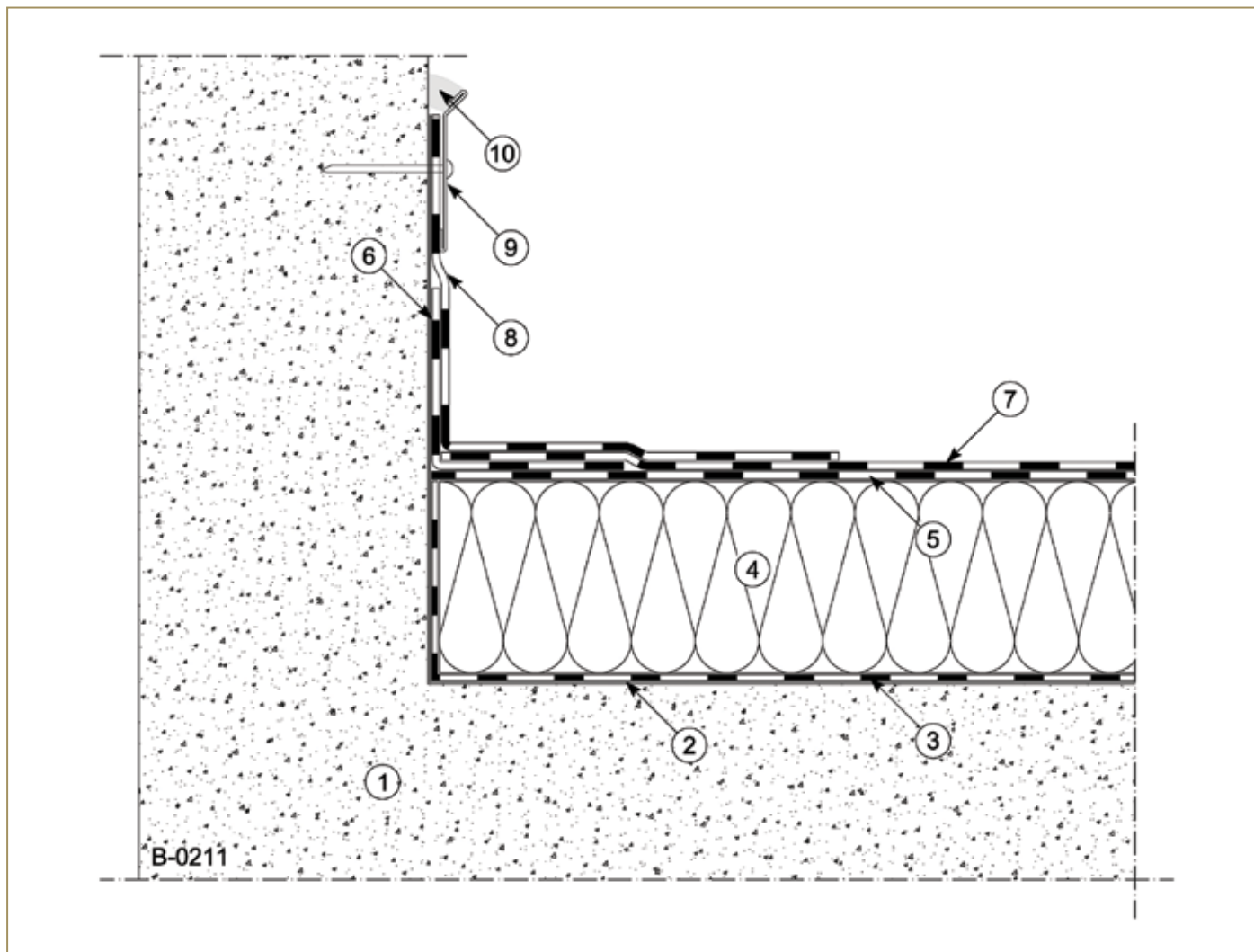

- ① Substrate/roof deck
- ② Bituminous primer (for example **IDROPRIMER**)
- ③ Vapour barrier (for example. **POLYVAP SA**)
- ④ Thermal insulation panel
- ⑤ 1<sup>st</sup> waterproofing layer, **ADESO**<sup>®</sup> waterproofing membrane
- ⑥ 1<sup>st</sup> waterproofing layer for vertical up-turn, **ADESO**<sup>®</sup> waterproofing membrane
- ⑦ 2<sup>nd</sup> Waterproofing layer, **ADESO**<sup>®</sup> mineral surfaced waterproofing membrane
- ⑧ 2<sup>nd</sup> Waterproofing layer for vertical up-turn, **ADESO**<sup>®</sup> mineral surfaced waterproofing membrane
- ⑨ Metal termination profile
- ⑩ Sealant (for example **POLYDETAIL MS**)

## Drawing B-0311 - Skylight connection

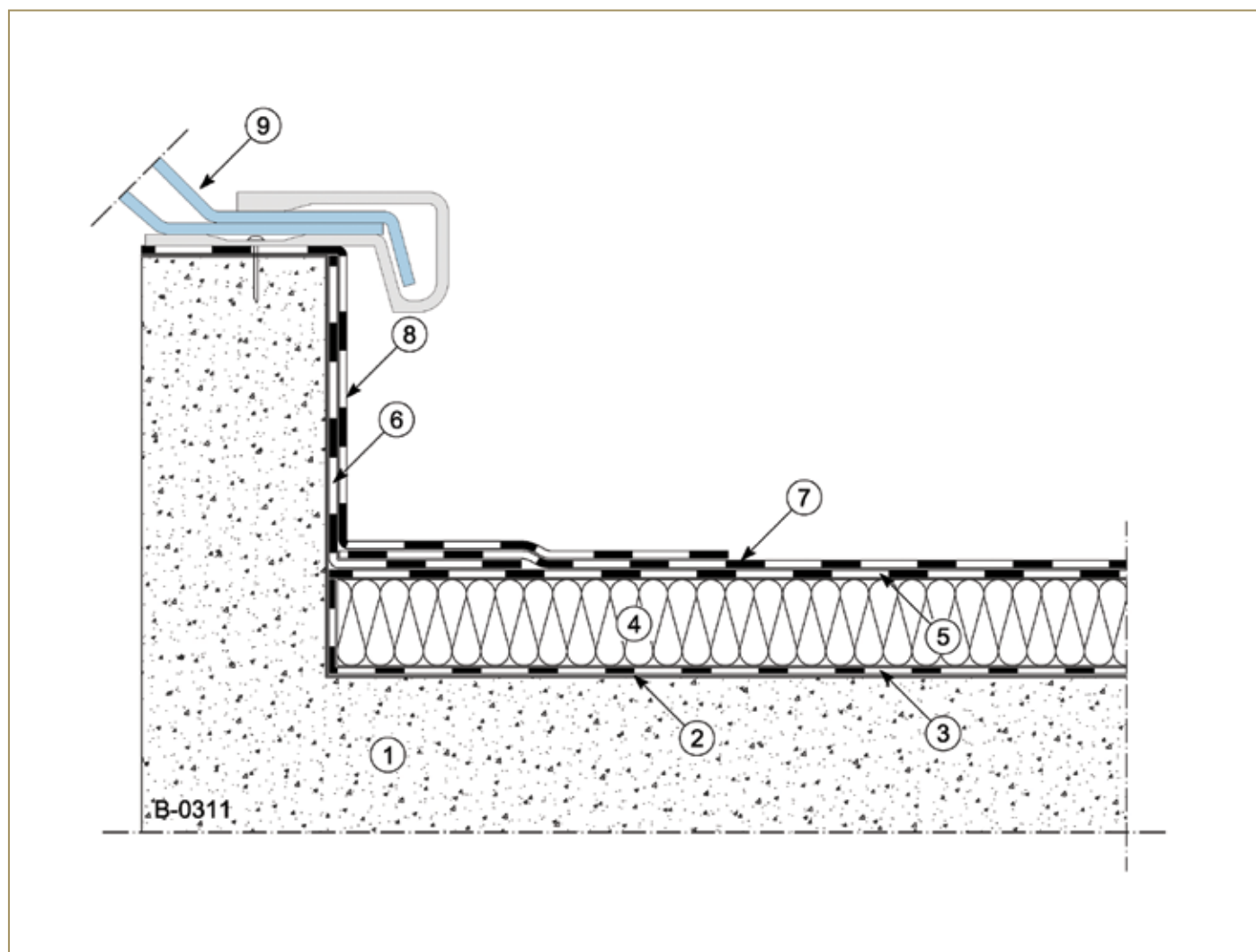

- ① Substrate/roof deck
- ② Bituminous primer (for example. IDROPRIMER)
- ③ Vapour barrier (for example POLYVAP SA)
- ④ Thermal insulation panel
- ⑤ 1<sup>st</sup> waterproofing layer, **ADESO**® waterproofing membrane
- ⑥ 1<sup>st</sup> waterproofing layer for vertical up-turn, **ADESO**® waterproofing membrane
- ⑦ 2<sup>nd</sup> Waterproofing layer, **ADESO**® mineral surfaced waterproofing membrane
- ⑧ 2<sup>nd</sup> Waterproofing layer for vertical up-turn, **ADESO**® mineral surfaced waterproofing membrane
- ⑨ Skylight

## Drawing B-0315 - Skylight

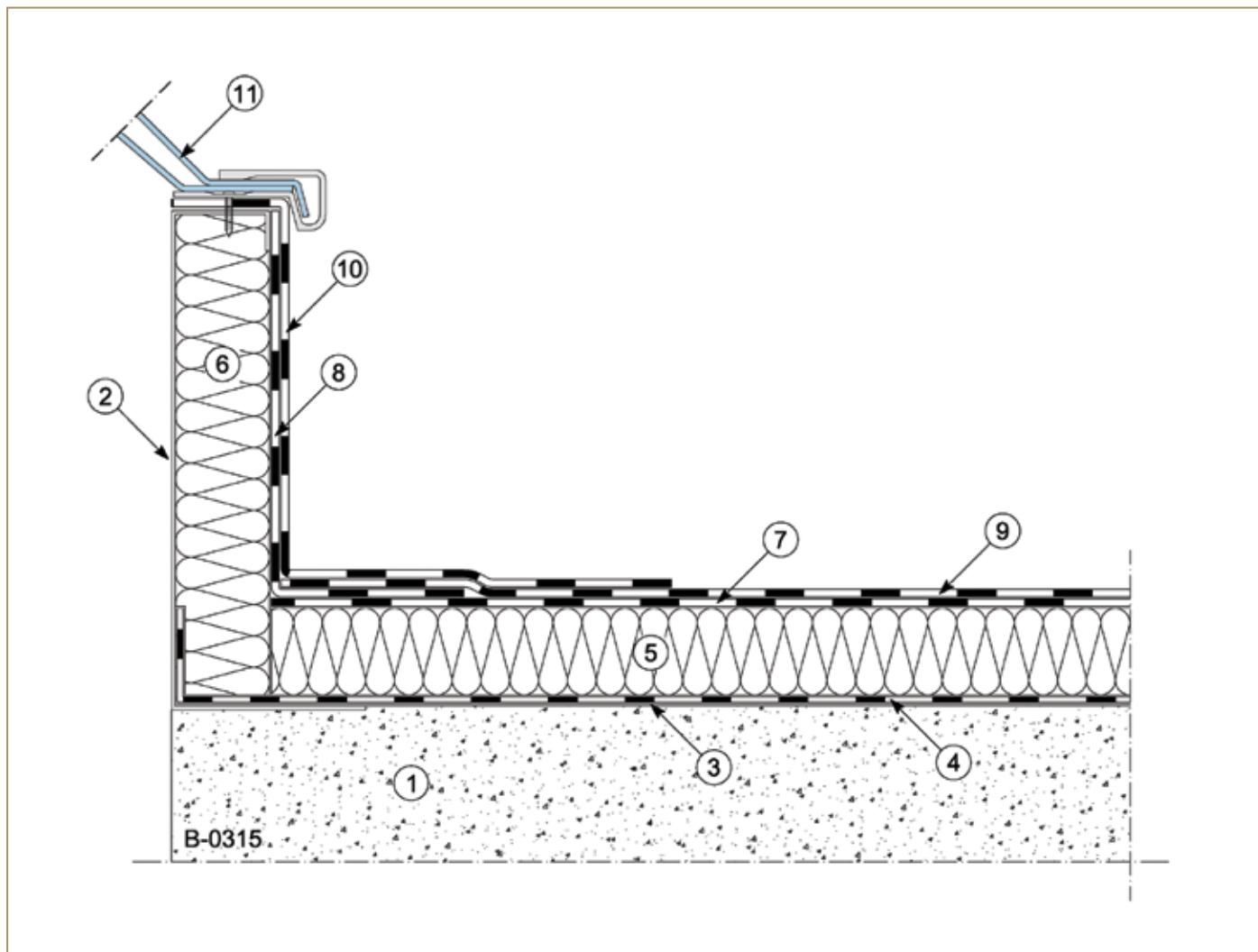

- ① Substrate/roof deck
- ② Skylight base
- ③ Bituminous primer (for example **IDROPRIMER**)
- ④ Vapour barrier (for example **POLYVAP SA**)
- ⑤ Thermal insulation panel
- ⑥ Thermal insulation panel on skylight base
- ⑦ 1<sup>st</sup> waterproofing layer, **ADESO**® waterproofing membrane
- ⑧ 1<sup>st</sup> waterproofing layer for vertical up-turn, **ADESO**® waterproofing membrane
- ⑨ 2<sup>nd</sup> Waterproofing layer, **ADESO**® mineral surfaced waterproofing membrane
- ⑩ 2<sup>nd</sup> Waterproofing layer for vertical up-turn, **ADESO**® mineral surfaced waterproofing membrane
- ⑪ Skylight

## Drawing B-0403 - Roof outlet

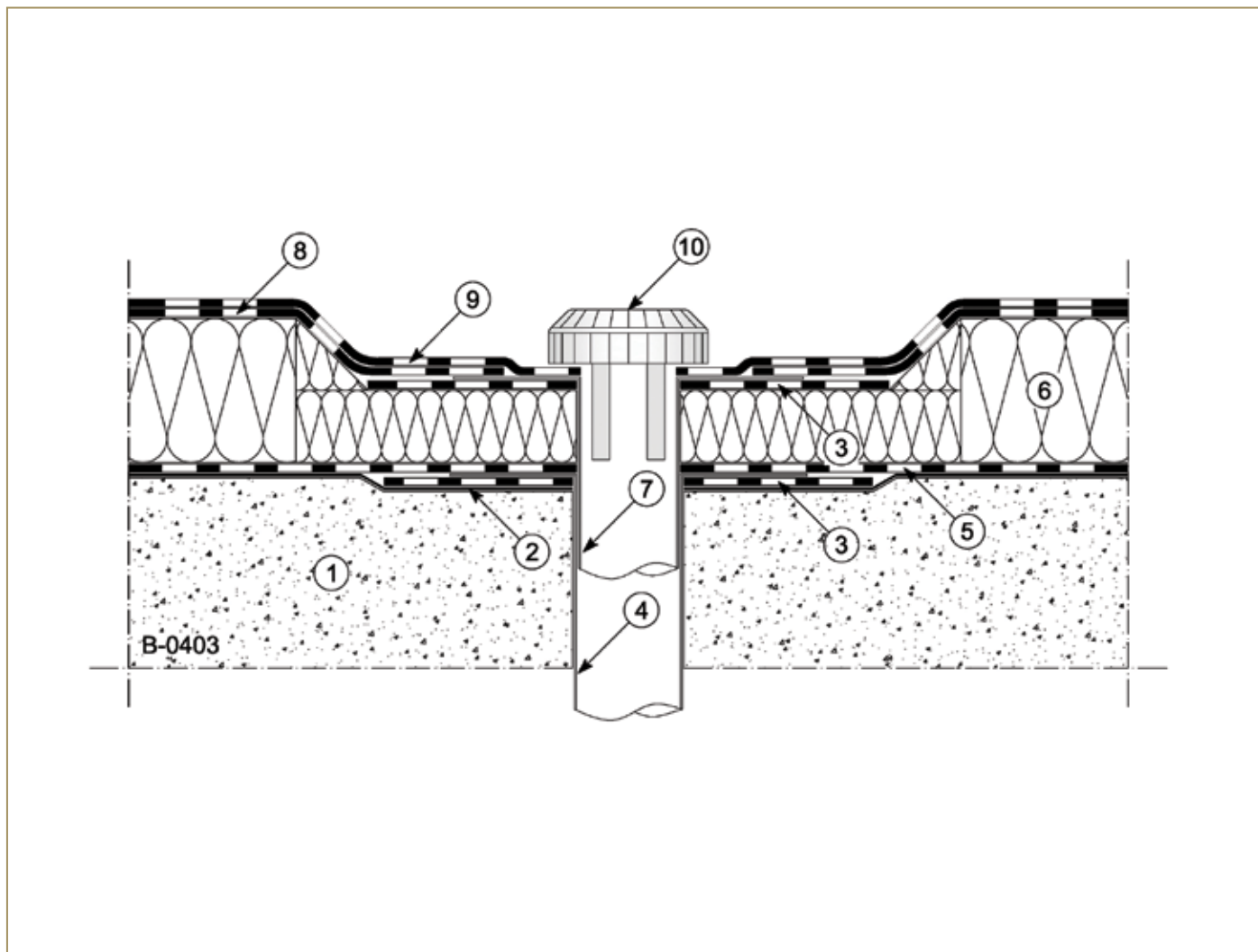

- ① Substrate/roof deck
- ② Bituminous primer (for example **IDROPRIMER**)
- ③ **ADESO**® Waterproofing bituminous membrane under roof outlet component
- ④ Roof outlet component for vapour barrier
- ⑤ Vapour barrier (for example. **POLYVAP SA**)
- ⑥ Thermal insulation panel
- ⑦ Roof outlet component for waterproofing layer
- ⑧ 1<sup>st</sup> waterproofing layer, **ADESO**® waterproofing membrane
- ⑨ 2<sup>nd</sup> Waterproofing layer, **ADESO**® mineral surfaced waterproofing membrane
- ⑩ Gravel/leaves guard

## Drawing B-0405 - Roof outlet

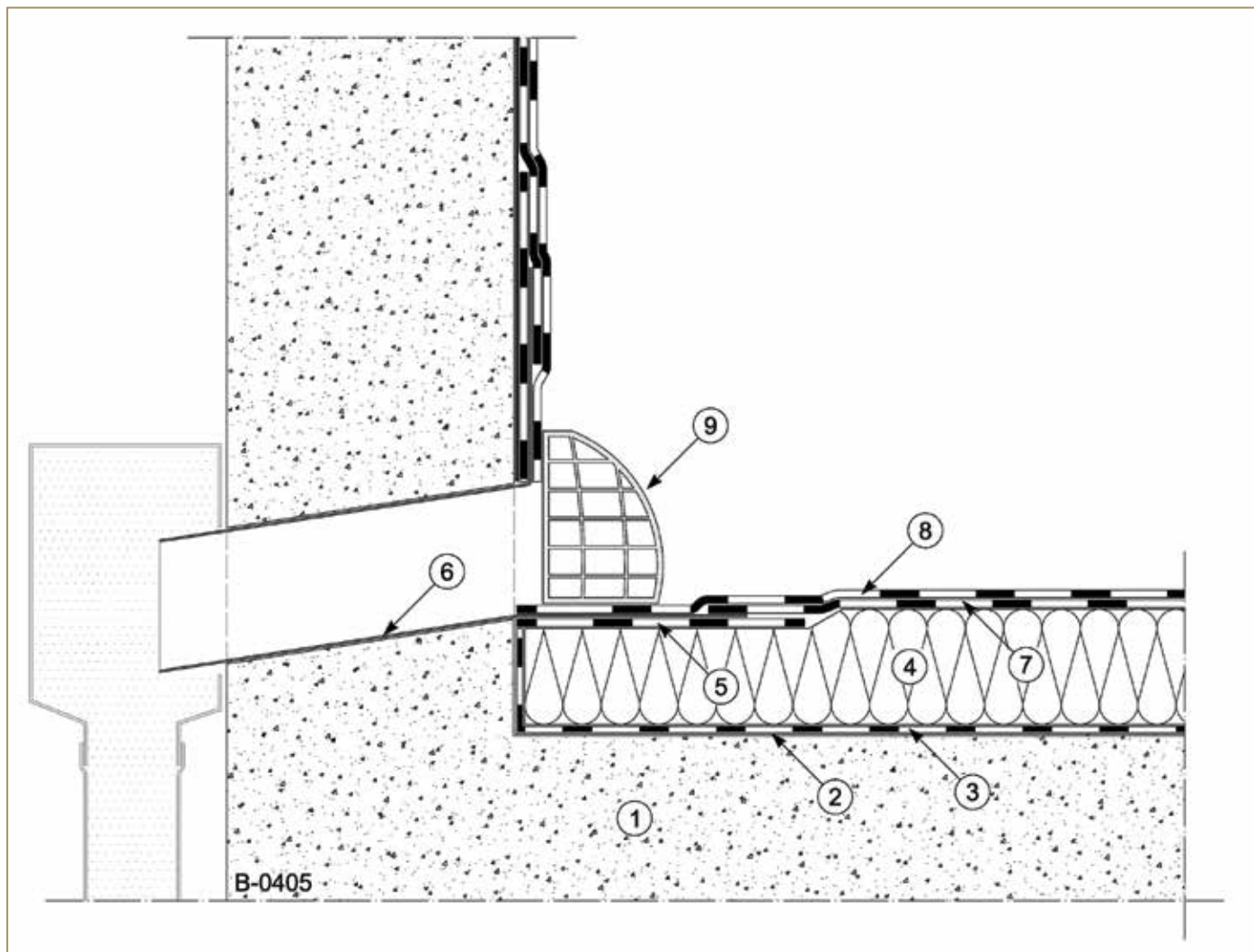

- ① Substrate/roof deck
- ② Bituminous primer (for example **IDROPRIMER**)
- ③ Vapour barrier (for example **POLYVAP SA**)
- ④ Thermal insulation panel
- ⑤ **ADESO**® waterproofing membrane under roof outlet component
- ⑥ Roof outlet component for waterproofing layer
- ⑦ 1<sup>st</sup> waterproofing layer, **ADESO**® waterproofing membrane
- ⑧ 2<sup>nd</sup> Waterproofing layer, **ADESO**® mineral surfaced waterproofing membrane
- ⑨ Gravel/leaf guard

## Drawing B-0500 - Vent pipe

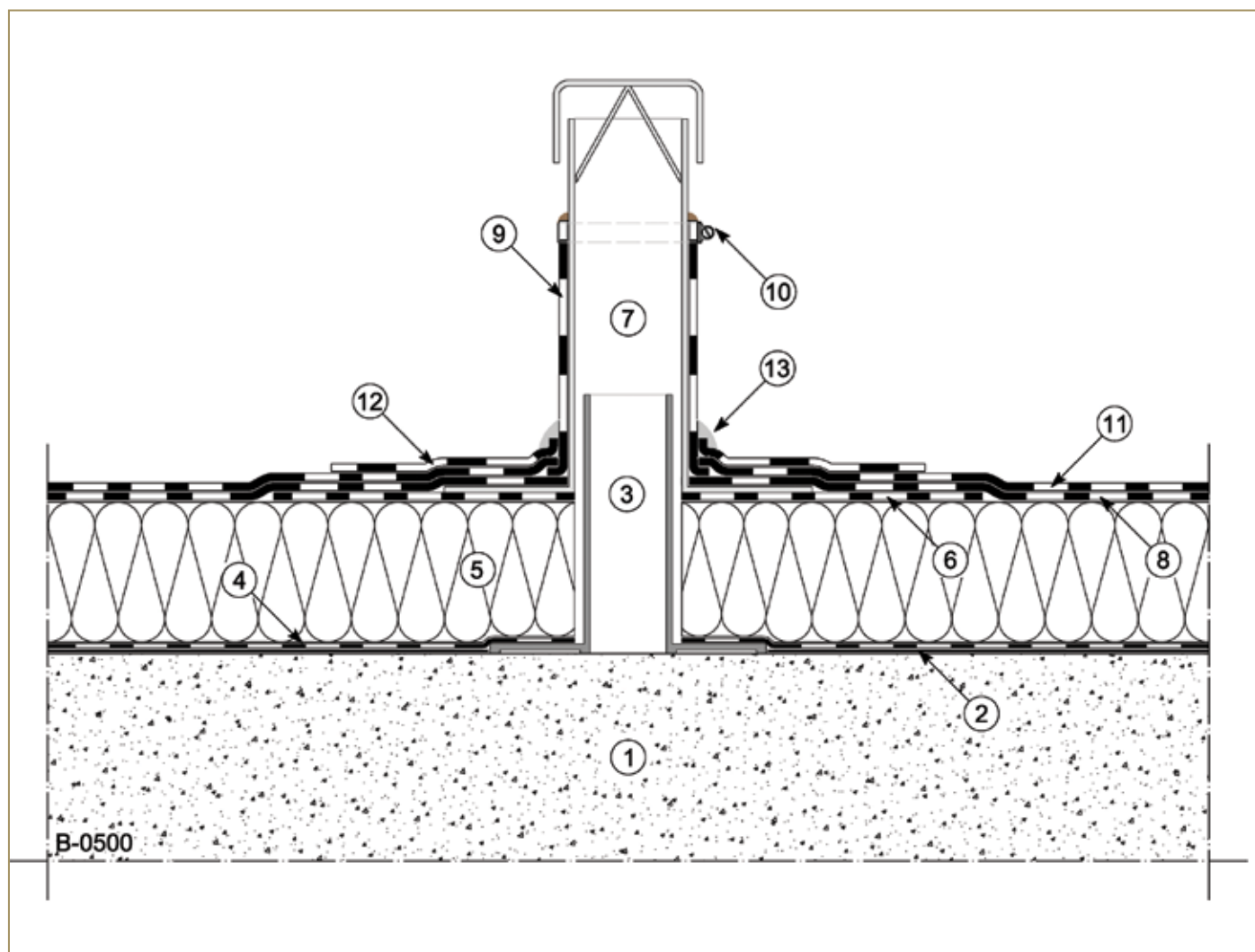

- ① Substrate/roof deck
- ② Bituminous primer (for example **IDROPRIMER**)
- ③ Vent pipe element for vapour barrier
- ④ Vapour barrier (for example **POLYVAP SA**)
- ⑤ Thermal insulation panel
- ⑥ **ADESO**® waterproofing membrane under vent pipe component
- ⑦ Vent pipe component for waterproofing layer
- ⑧ 1<sup>st</sup> waterproofing layer, **ADESO**® waterproofing membrane
- ⑨ Waterproofing bituminous membrane **ADESO**® with mineral surface for pipe covering
- ⑩ Stainless steel worm gear hose clamp
- ⑪ 2<sup>nd</sup> Waterproofing layer, **ADESO**® mineral surfaced waterproofing membrane
- ⑫ Circular piece of **ADESO**® waterproofing membrane with mineral surface
- ⑬ Sealant (for example **POLYDETAIL MS**)

## Drawing B-0513 - Pipe penetration

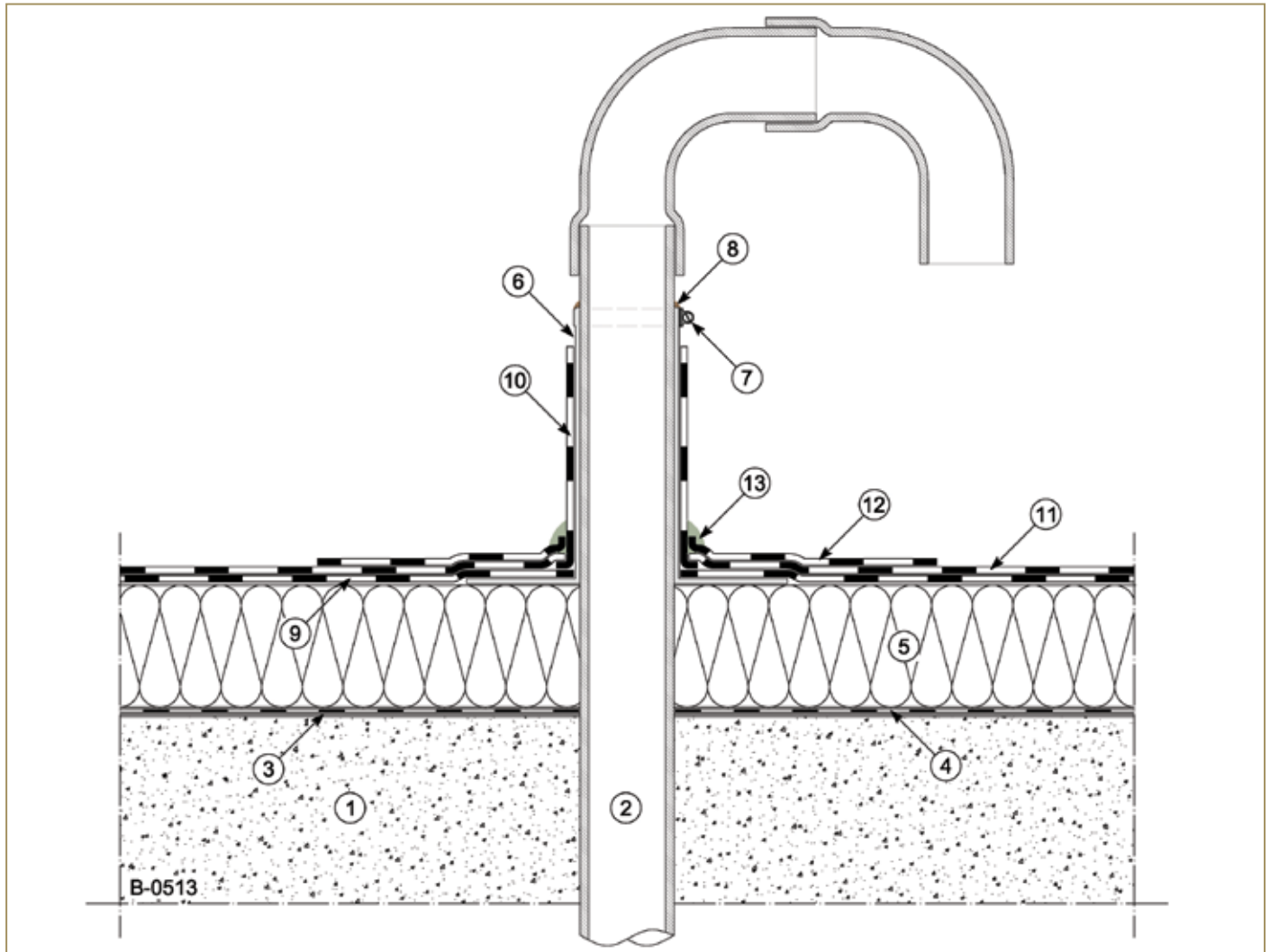

- ① Substrate/roof deck
- ② Pipe
- ③ Bituminous primer (for example **IDROPRIMER**)
- ④ Vapour barrier (for example **POLYVAP SA**)
- ⑤ Thermal insulation panel
- ⑥ Pipe covering element
- ⑦ Stainless steel worm gear hose clamp
- ⑧ Sealant (for example **POLYDETAIL MS**)
- ⑨ 1<sup>st</sup> waterproofing layer, **ADESO**® waterproofing membrane
- ⑩ Waterproofing bituminous membrane **ADESO**® with mineral surface for pipe covering
- ⑪ 2<sup>nd</sup> Waterproofing layer, **ADESO**® mineral surfaced waterproofing membrane
- ⑫ Circular piece of **ADESO**® waterproofing membrane with mineral surface
- ⑬ Sealant (for example **POLYDETAIL MS**)



## Drawing B-0603 - Expansion joint

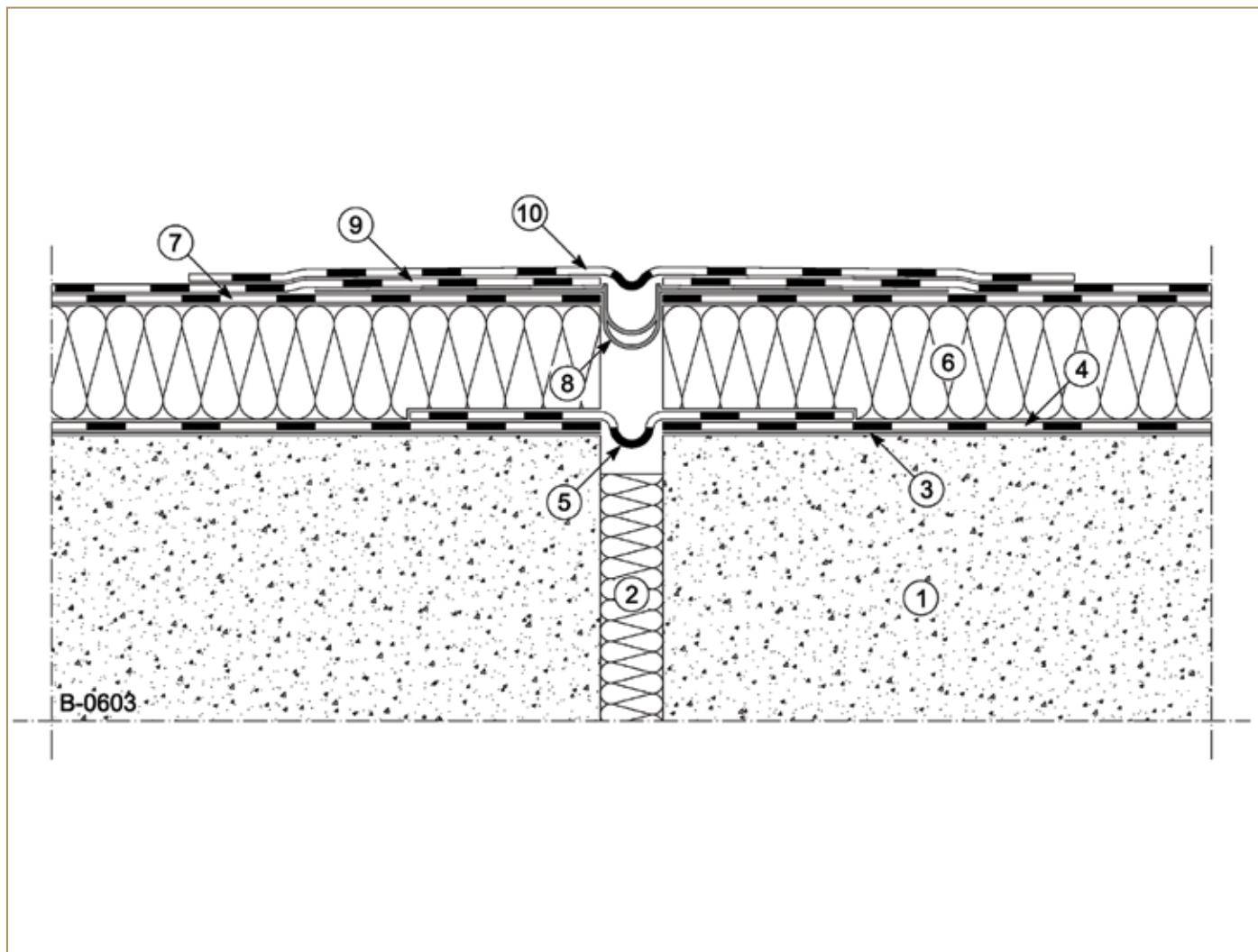

- ① Substrate/roof deck
- ② Compressible insulation element
- ③ Bituminous primer (for example **IDROPRIMER**)
- ④ Vapour barrier (for example **POLYVAP SA**)
- ⑤ Expansion joint made with a strip of **ADESO**® vapour barrier
- ⑥ Thermal insulation panel
- ⑦ 1<sup>st</sup> waterproofing layer, **ADESO**® waterproofing membrane
- ⑧ Expansion joint **OMEGA**
- ⑨ 2<sup>nd</sup> Waterproofing layer, **ADESO**® mineral surfaced waterproofing membrane
- ⑩ **ADESO**® mineral surfaced bituminous membrane for covering the joint

## Drawing B-0607 - Expansion joint in precast structure

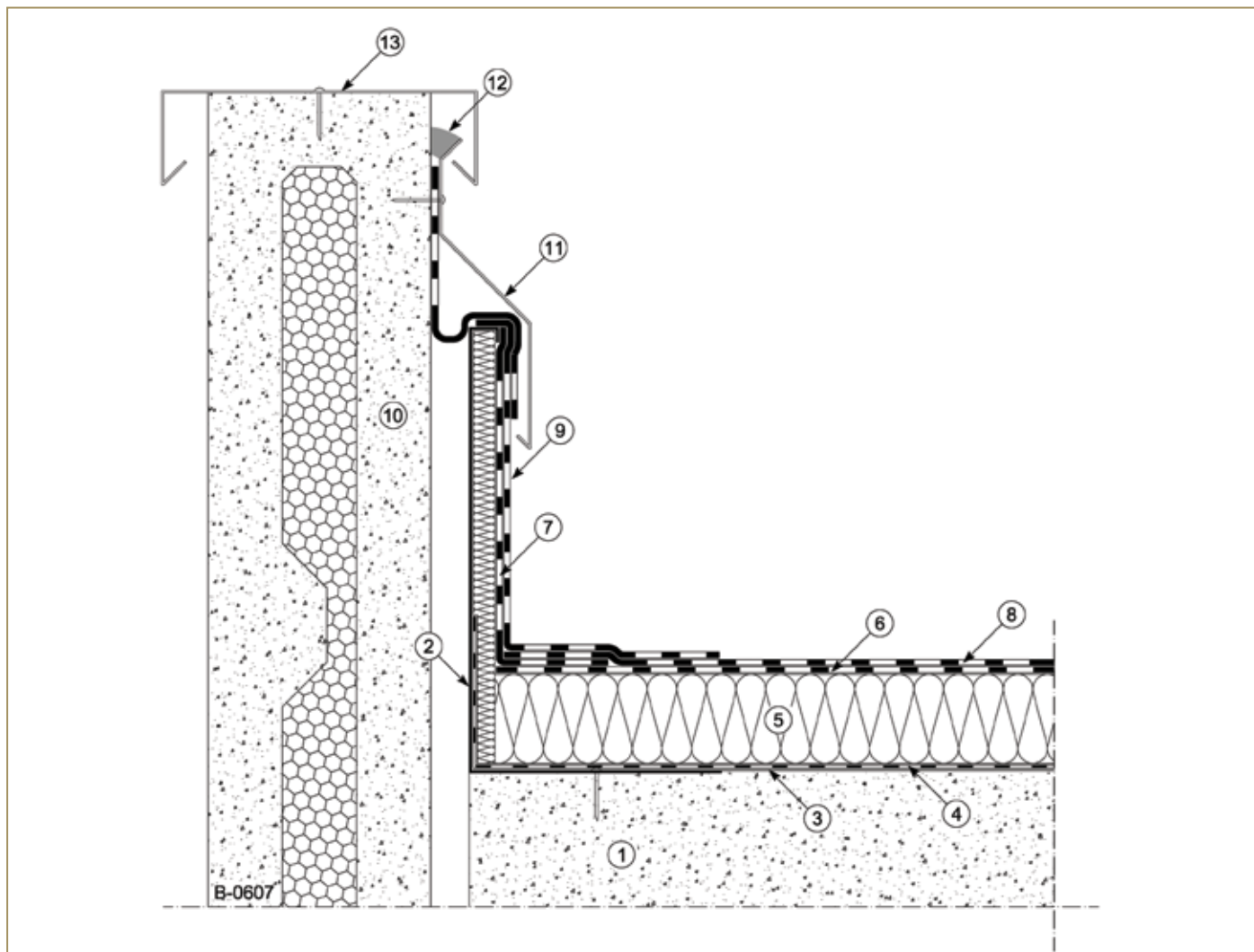

- ① Substrate/roof deck
- ② Galvanized perimeter metal profile
- ③ Bituminous primer (for example **IDROPRIMER**)
- ④ Vapour barrier (for example **POLYVAP SA**)
- ⑤ Thermal insulation panel
- ⑥ 1<sup>st</sup> waterproofing layer, **ADESO**® waterproofing membrane
- ⑦ 1<sup>st</sup> waterproofing layer for vertical up-turn, **ADESO**® waterproofing membrane
- ⑧ 2<sup>nd</sup> Waterproofing layer, **ADESO**® mineral surfaced waterproofing membrane
- ⑨ 2<sup>nd</sup> Waterproofing layer for vertical up-turn, **ADESO**® mineral surfaced waterproofing membrane
- ⑩ Precast vertical perimeter element
- ⑪ Metal flashing profile for joint covering
- ⑫ Sealant (for example **POLYDETAIL MS**)
- ⑬ Perimeter metal flashing profile

## Drawing B-0608 - Perimeter expansion joint

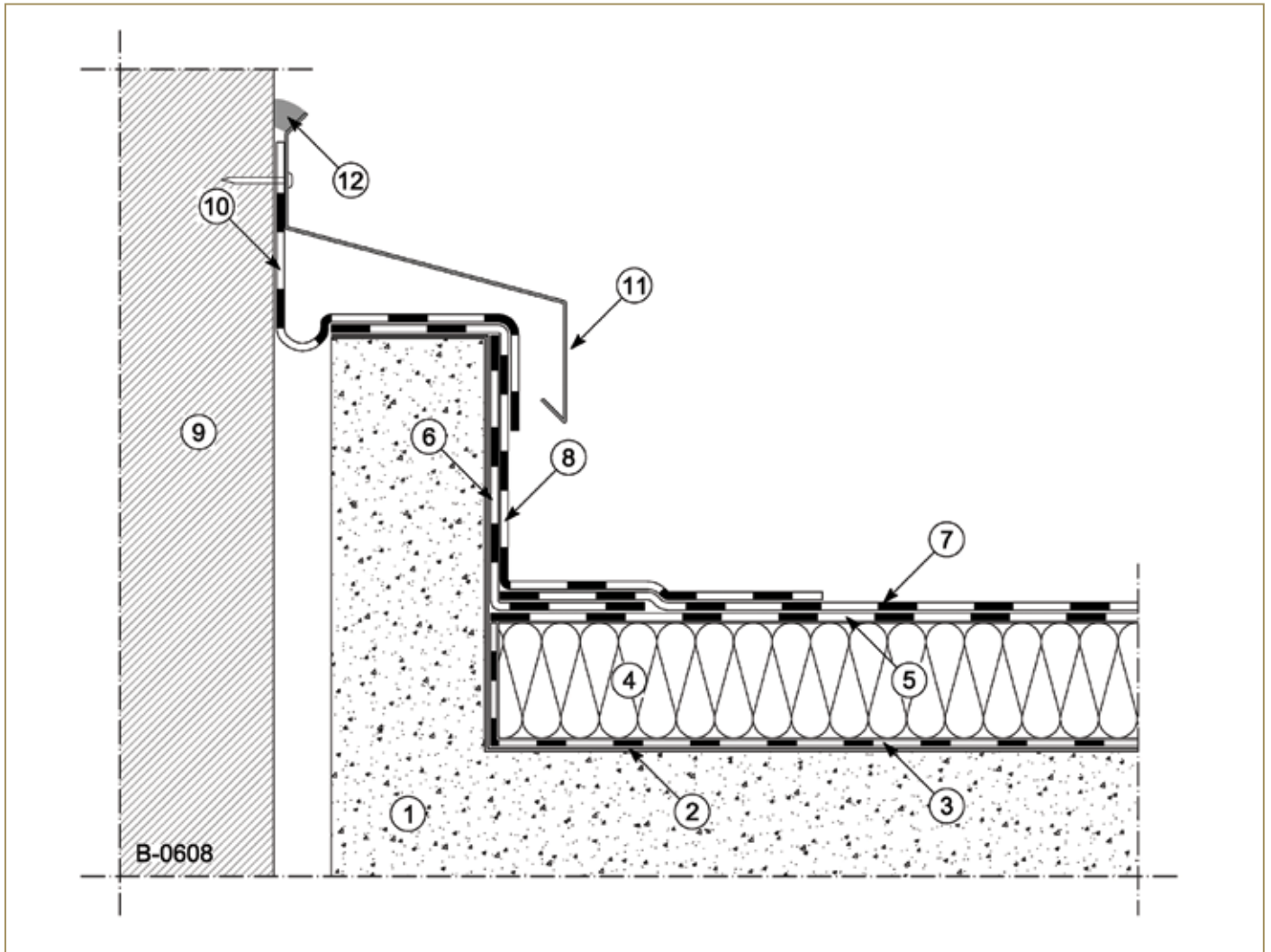

- ① Substrate/roof deck
- ② Bituminous primer (for example **IDROPRIMER**)
- ③ Vapour barrier (for example **POLYVAP SA**)
- ④ Thermal insulation panel
- ⑤ 1<sup>st</sup> waterproofing layer, **ADESO**® waterproofing membrane
- ⑥ 1<sup>st</sup> waterproofing layer for vertical up-turn, **ADESO**® waterproofing membrane
- ⑦ 2<sup>nd</sup> Waterproofing layer, **ADESO**® mineral surfaced waterproofing membrane
- ⑧ 2<sup>nd</sup> Waterproofing layer for vertical up-turn, **ADESO**® mineral surfaced waterproofing membrane
- ⑨ Vertical wall of adjacent structure
- ⑩ Connection membrane
- ⑪ Metal flashing
- ⑫ Sealant (for example **POLYDETAIL MS**)

## Drawing B-0609 - Expansion joint

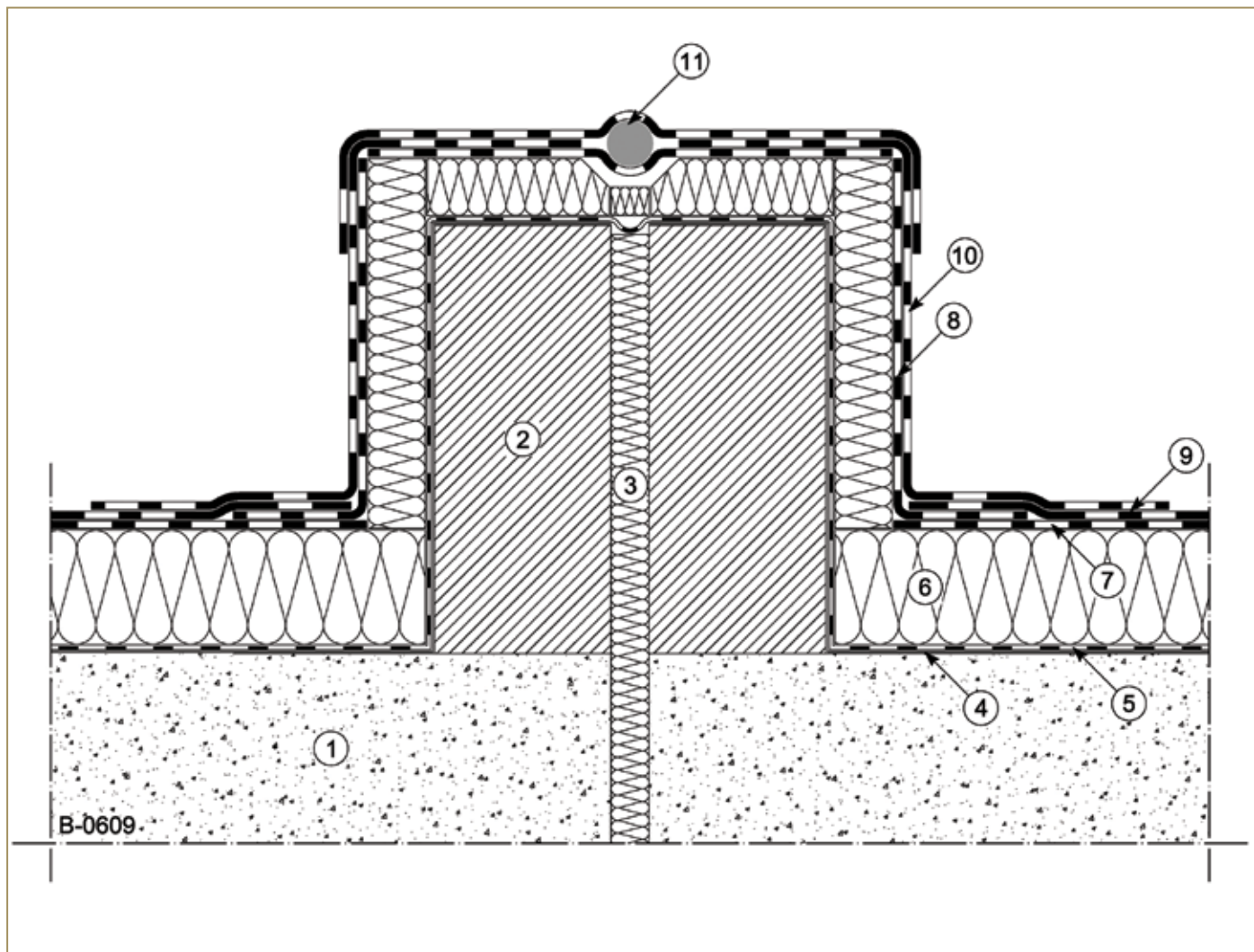

- ① Substrate/roof deck
- ② Concrete kerb for the joint
- ③ Compressible insulation element
- ④ Bituminous primer (for example **IDROPRIMER**)
- ⑤ Vapour barrier (for example **POLYVAP SA**)
- ⑥ Thermal insulation panel
- ⑦ 1<sup>st</sup> waterproofing layer, **ADESO**® waterproofing membrane
- ⑧ 1<sup>st</sup> waterproofing layer for vertical up-turn, **ADESO**® waterproofing membrane
- ⑨ 2<sup>nd</sup> Waterproofing layer, **ADESO**® mineral surfaced waterproofing membrane
- ⑩ 2<sup>nd</sup> Waterproofing layer for vertical up-turn, **ADESO**® mineral surfaced waterproofing membrane
- ⑪ Expanded polyurethane cord

## Drawing B-0610 - Expansion joint

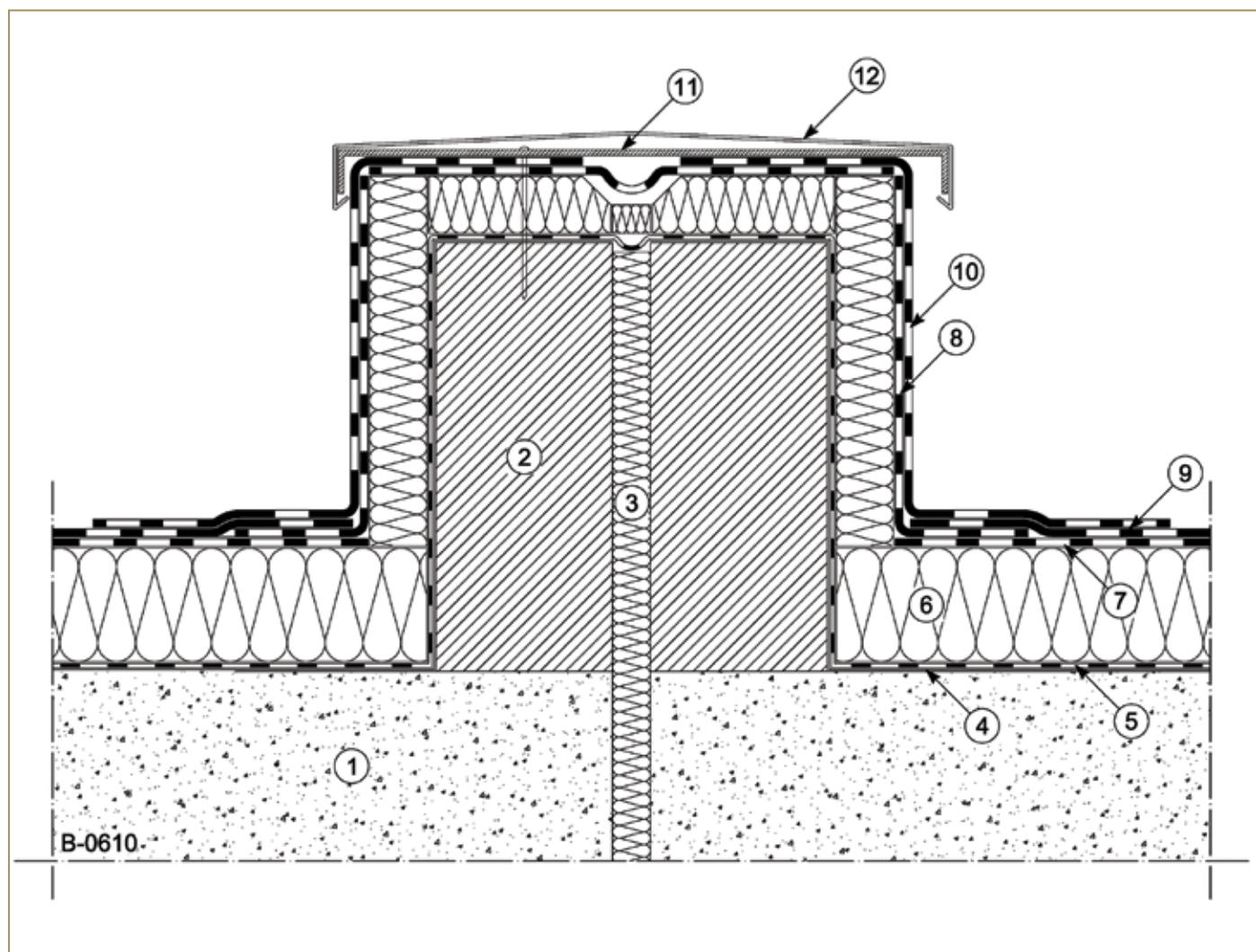

- ① Substrate/roof deck
- ② Concrete kerb for the joint
- ③ Compressible insulation element
- ④ Bituminous primer (for example **IDROPRIMER**)
- ⑤ Vapour barrier (for example **POLYVAP SA**)
- ⑥ Thermal insulation panel
- ⑦ 1<sup>st</sup> waterproofing layer, **ADESO**<sup>®</sup> waterproofing membrane
- ⑧ 1<sup>st</sup> waterproofing layer for vertical up-turn, **ADESO**<sup>®</sup> waterproofing membrane
- ⑨ 2<sup>nd</sup> Waterproofing layer, **ADESO**<sup>®</sup> mineral surfaced waterproofing membrane
- ⑩ 2<sup>nd</sup> Waterproofing layer for vertical up-turn, **ADESO**<sup>®</sup> mineral surfaced waterproofing membrane
- ⑪ Metallic bracket anchored only on one side
- ⑫ Metal flashing

## Drawing B-0611 - Expansion joint

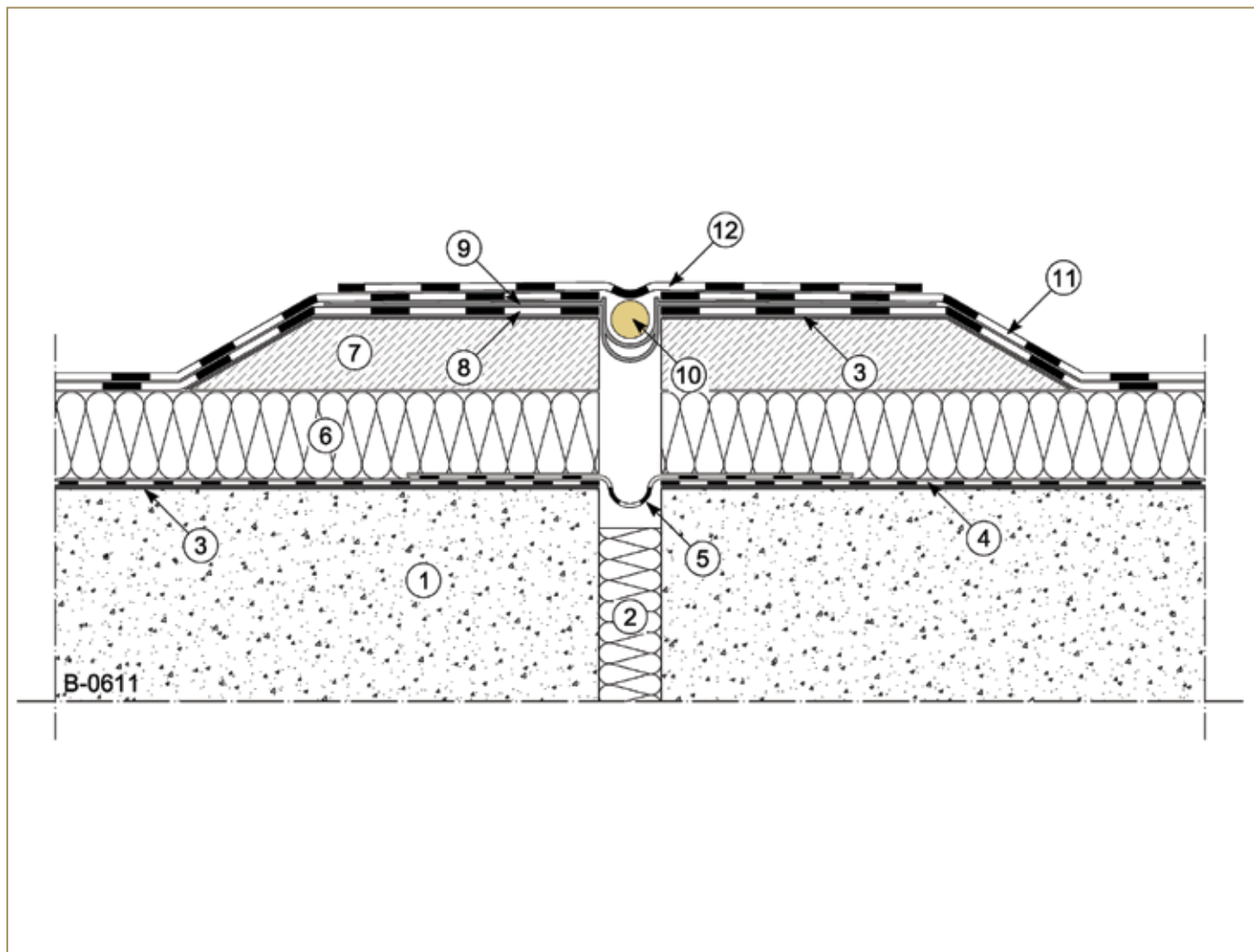

- ① Substrate/roof deck
- ② Compressible insulation element
- ③ Bituminous primer (for example **IDROPRIMER**)
- ④ Vapour barrier (for example **POLYVAP SA**)
- ⑤ Expansion joint made with a strip of **ADESO**® vapour barrier
- ⑥ Thermal insulation layer
- ⑦ Rased component
- ⑧ 1<sup>st</sup> waterproofing layer, **ADESO**® waterproofing membrane )
- ⑨ Expansion joint **OMEGA**
- ⑩ Expanded polyurethane cord
- ⑪ 2<sup>nd</sup> Waterproofing layer, **ADESO**® mineral surfaced waterproofing membrane
- ⑫ **ADESO**® mineral surface bituminous membrane for joint covering

## Drawing B-0902 - Foundation wall with rising damp

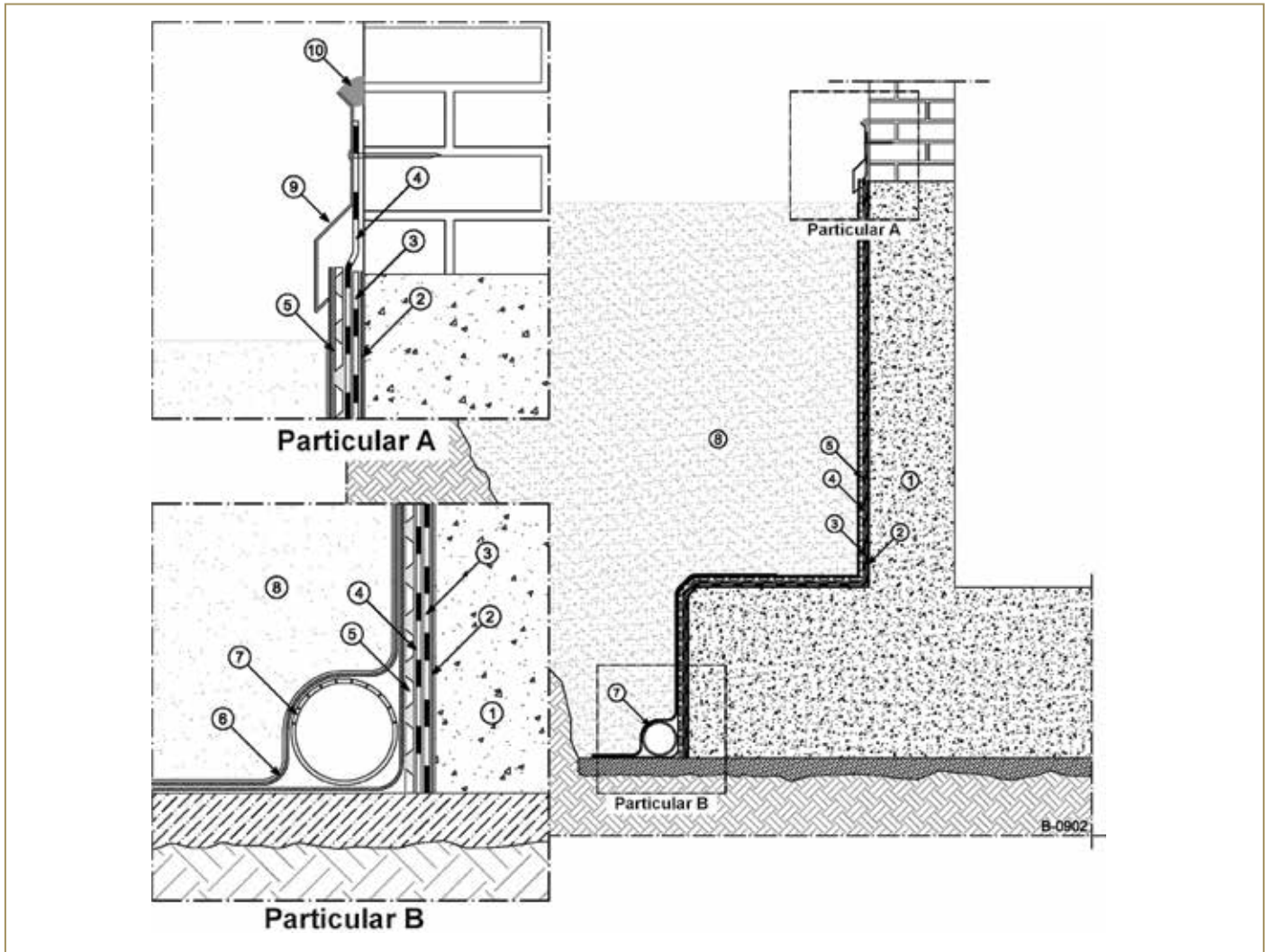

- ① Foundation perimeter wall
- ② Bituminous primer (for example **IDROPRIMER**)
- ③ 1<sup>st</sup> waterproofing layer, **ADESO**® waterproofing membrane
- ④ 2<sup>nd</sup> Waterproofing layer, **ADESO**® waterproofing membrane
- ⑤ Protective and drainage layer **POLYFOND KIT DRAIN**
- ⑥ Filtering layer with non-woven geotextile
- ⑦ Micro-perforated drainage pipe
- ⑧ Refill with soil
- ⑨ Stainless steel flashing profile
- ⑩ Sealant (for example **POLYDETAIL MS**)

## Drawing B-1112 - Ridge of sloped roof

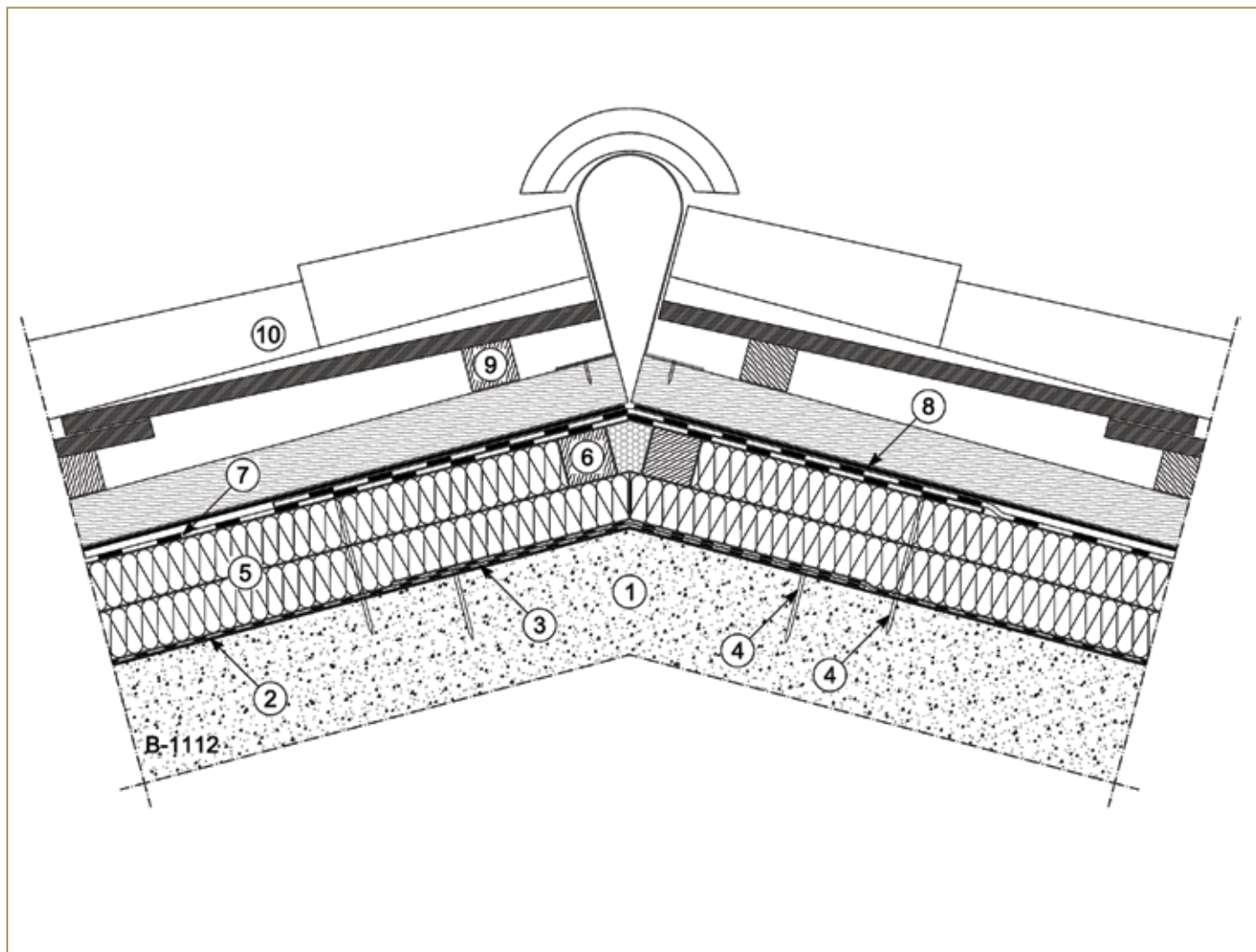

- ① Substrate/roof deck
- ② Bituminous primer (for example **IDROPRIMER**)
- ③ Vapour barrier (for example **POLYVAP SA**)
- ④ Mechanical fixation on top edge of the roll
- ⑤ Double layer of thermal insulation panel
- ⑥ Restraint wooden batten
- ⑦ **ADESO**® waterproofing membrane suitable for use under roof tiles
- ⑧ Sealing tape **POLYTape PE FOAM**
- ⑨ Restraint wooden batten for anchorage of roof tiles
- ⑩ Roof tiles



## Drawing B-1113 - Ridge of sloped roof

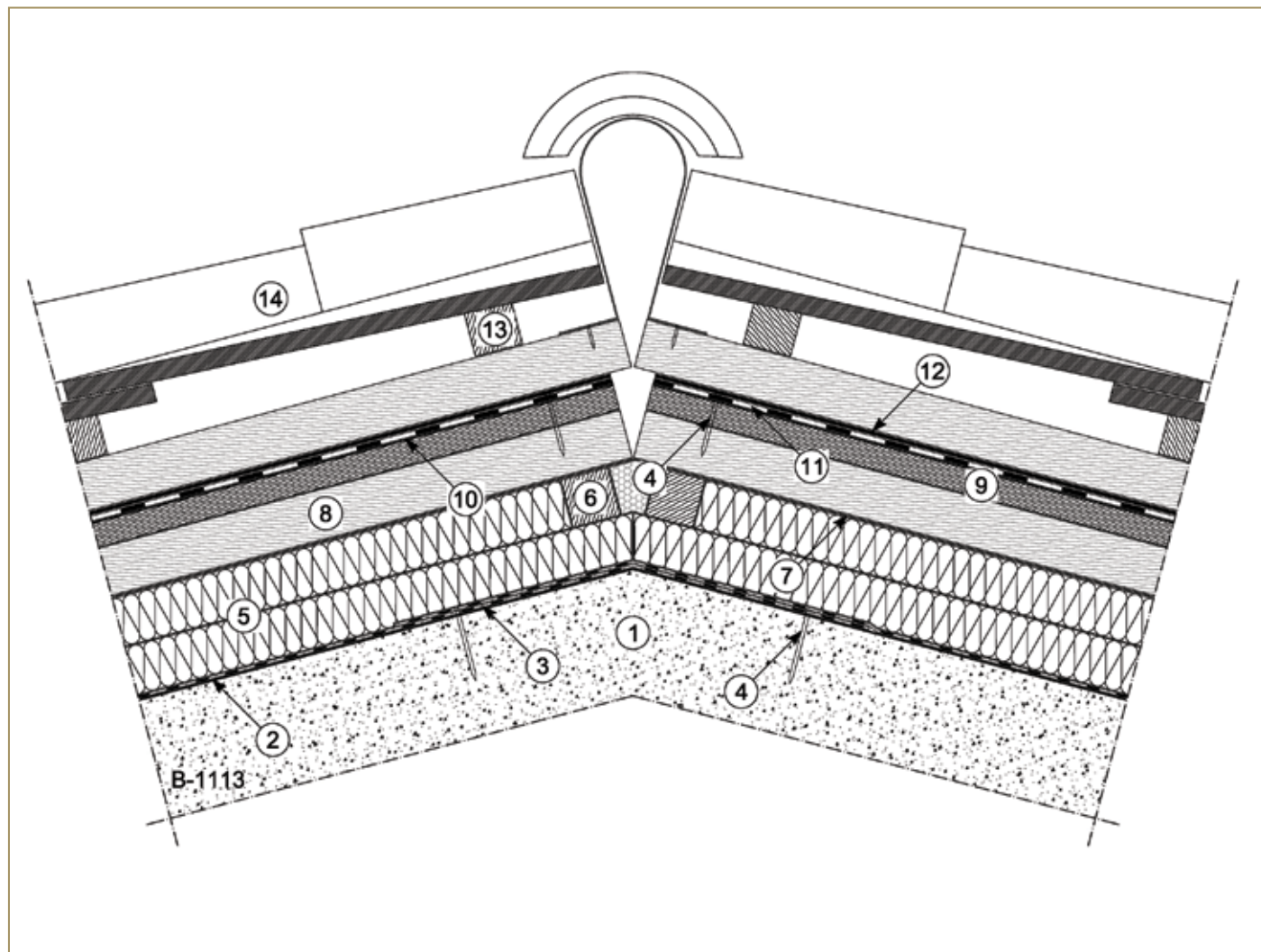

- ① Substrate/roof deck
- ② Bituminous primer (for example **IDROPRIMER**)
- ③ Vapour barrier (for example **POLYVAP SA**)
- ④ Mechanical fixing on top edge of the roll
- ⑤ Double layer of thermal insulation panel
- ⑥ Restraint wooden batten
- ⑦ Waterproofing highly breathable underlay (for example **SILVERTEK 15 SEAL LAP**)
- ⑧ Secondary timber batten for ventilation gap
- ⑨ OSB or PLYWOOD panels
- ⑩ Bituminous primer (for example **IDROPRIMER**)
- ⑪ **ADESO**® waterproofing membrane suitable for use under roof tiles
- ⑫ Sealing tape **POLYTAPE PE FOAM**
- ⑬ Restraint wooden batten for anchorage of roof tiles
- ⑭ Roof tiles

## Drawing B-1114 - Eave of sloped roof

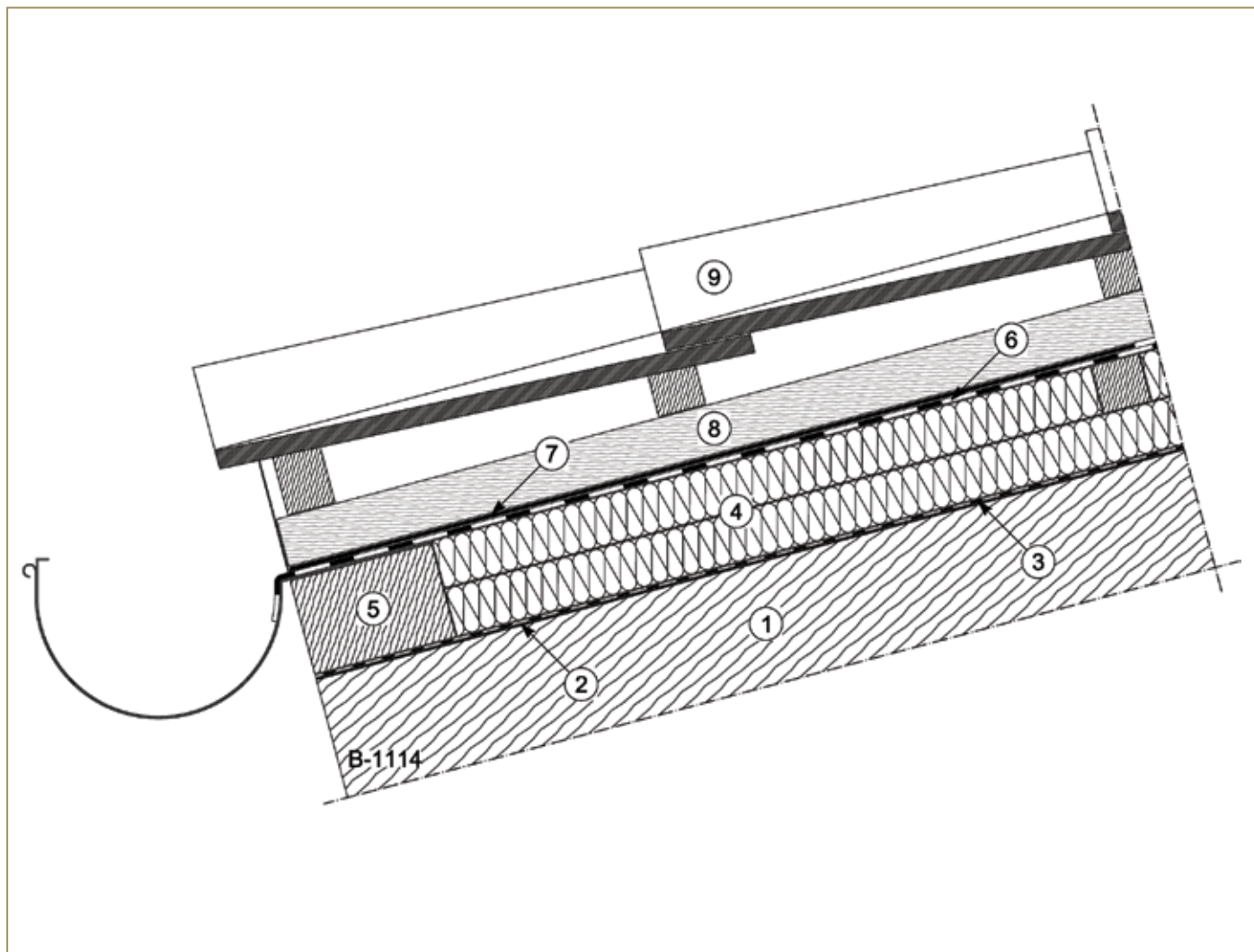

- ① Substrate/roof deck
- ② Bituminous primer (for example **IDROPRIMER**)
- ③ Vapour barrier (for example **POLYVAP SA**)
- ④ Double layer of thermal insulation panel
- ⑤ Restraint wooden batten
- ⑥ **ADESO**® waterproofing membrane suitable for use under roof tiles
- ⑦ Sealing tape **POLYTape PE FOAM**
- ⑧ Restraint wooden batten for anchorage of roof tiles
- ⑨ Roof tiles

## Drawing B-1115 - Eave of sloped roof

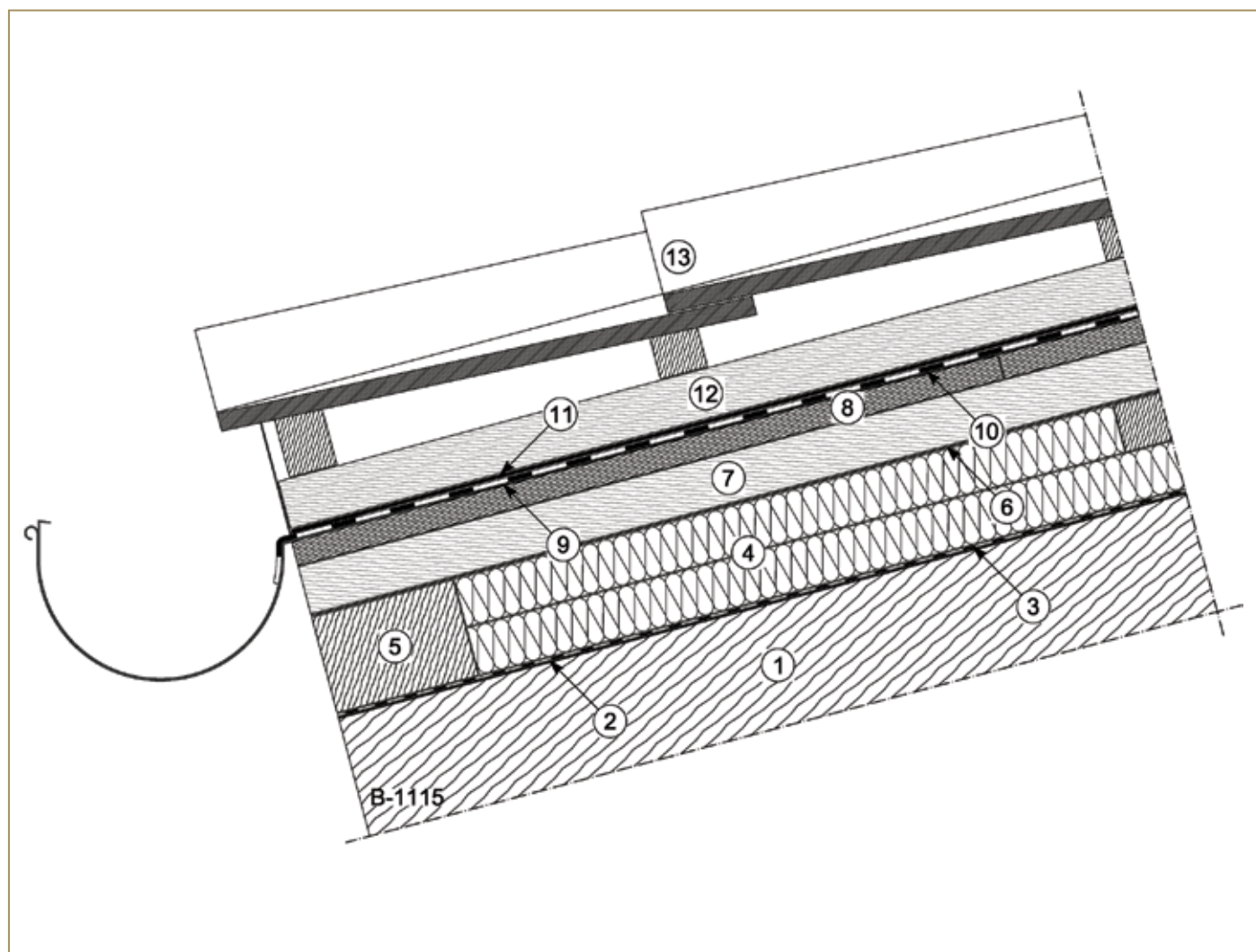

- ① Substrate/roof deck
- ② Bituminous primer (for example **IDROPRIMER**)
- ③ Vapour barrier (for example **POLYVAP SA**)
- ④ Double layer of thermal insulation panel
- ⑤ Restraint wooden batten
- ⑥ Waterproofing highly breathable underlay (for example **SILVERTEK 15 SEAL LAP**)
- ⑦ Secondary restraint wooden batten for ventilation gap
- ⑧ OSB or PLYWOOD panels
- ⑨ Bituminous primer (for example **IDROPRIMER**)
- ⑩ **ADESO**® Waterproofing membrane, suitable for use under roof tiles
- ⑪ Sealing tape **POLYTAPE PE FOAM**
- ⑫ Restraint wooden batten for anchorage of roof tiles
- ⑬ Roof tiles



## Drawing B-1117 - Wall connection on sloped roof

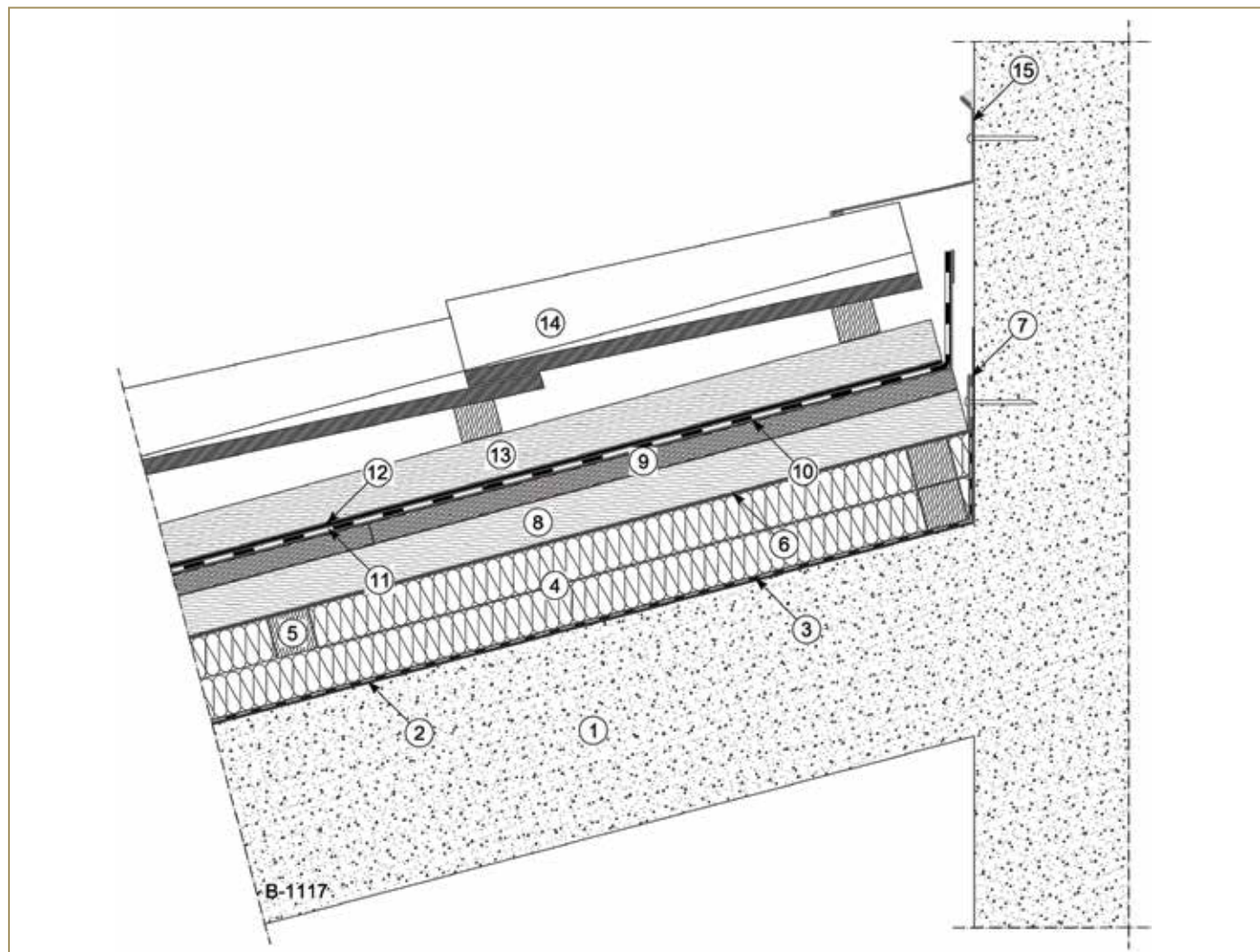

- ① Substrate/roof deck
- ② Bituminous primer (for example **IDROPRIMER**)
- ③ Vapour barrier (for example **POLYVAP SA**)
- ④ Double layer of thermal insulation panel
- ⑤ Restraint wooden batten
- ⑥ Waterproofing highly breathable underlay (for example **SILVERTEK 15 SEAL LAP**)
- ⑦ Mechanical fixation on top edge of the roll
- ⑧ Secondary restraint wooden batten for ventilation gap
- ⑨ OSB or PLYWOOD panels
- ⑩ Bituminous primer (for example **IDROPRIMER**)
- ⑪ **ADESO**® waterproofing membrane suitable for use under roof tiles
- ⑫ Sealing tape **POLYTAPE PE FOAM**
- ⑬ Restraint wooden batten for anchorage of roof tiles
- ⑭ Roof tiles
- ⑮ Metal flashing







POLYGLASS SPA

Head Office: Viale Jenner, 4 - 20159 Milano - Italy

Registered Office: Via dell'Artigianato, 34 - 31047 Ponte di Piave (TV) - Italy

Tel. +39 04227547 - Fax +39 0422854118 - [www.polyglass.com](http://www.polyglass.com) - [info@polyglass.it](mailto:info@polyglass.it)