



• profiles for walls

PROJOLLY SQUARE

POLISHED, SUPER POLISHED AND SATINED STAINLESS STEEL AISI 304/1.4301-V2A

PROJOLLY SQUARE is a square shaped as a right angle that is versatile and suitable for various laying solutions, both for floors and coverings. It is used as a staff angle for external corners of tile coverings. It facilitates laying and eliminates the brittle unpredictability of ceramic tiles. It is also used as a finishing square for finishing wall coverings, raised platforms, steps, and baths, and is used as an edge and a skirting board for parquet, natural stone, moquette and epoxy resin coverings. It guarantees flawless work done with care that is of great aesthetic merit. It strengthens tile edges with a square finish, protecting corners efficiently, avoiding chipping and breakages resulting from knocks. This is required by the new European regulations on safety and accident prevention in public and private places.

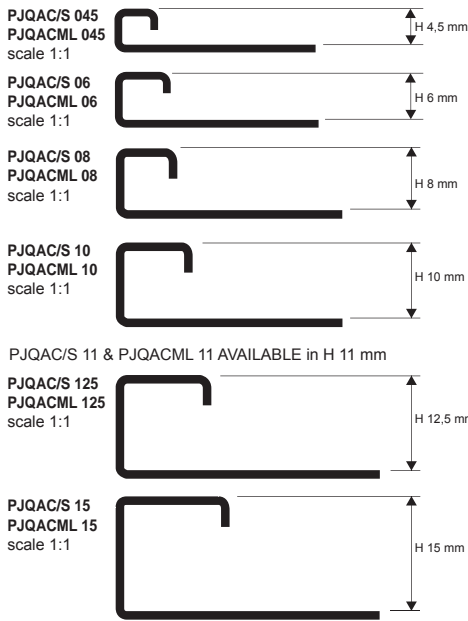

POLISHED STAINLESS STEEL AISI 304/1.4301-V2A with protective film - bar length 2,7 LM - packaging 40 Pcs - 108 LM (H 12,5 15 mm - 54 LM) - 8/10 mm

Article	H mm	€/LM	€/Pc
PQQAC 045	4,5	7,70	20,79
PQQAC 06	6	8,11	21,90
PQQAC 08	8	8,58	23,17
PQQAC 10	10	9,04	24,41
PQQAC 11	11	9,40	25,38
PQQAC 125	12,5	9,55	25,79
PQQAC 15	15	10,42	28,13

EXAMPLES AND INSTRUCTIONS FOR LAYING METHODS

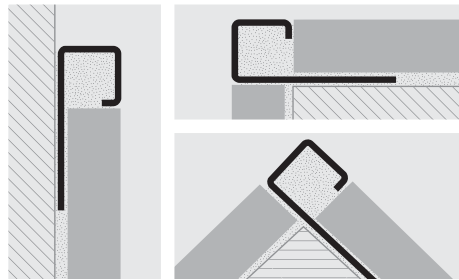

1. Choose a PROJOLLY SQUARE height corresponding to the thickness of the covering/floor. 2. Apply the adhesive in the area that the square is being applied. 3. Rest and line up the square, cut to the required length, pressing the perforated tab into the adhesive. 4. Place the tiles lining them up so that the upper part of the square meets with their edge. 5. Fill the contact area between square and tile completely with adhesive to prevent the accumulation of water in the empty spaces.

SATINED STAINLESS STEEL AISI 304/1.4301-V2A thermo packed bar length 2,7 LM - packaging 40 Pcs - 108 LM (H 12,5 - H 15 mm 54 LM) - 8/10 mm

Article	H mm	€/LM	€/Pc
PQQACS 045	4,5	8,93	24,11
PQQACS 06	6	9,40	25,38
PQQACS 08	8	11,35	30,65
PQQACS 10	10	11,91	32,16
PQQACS 11	11	12,12	32,72
PQQACS 125	12,5	12,43	33,56
PQQACS 15	15	13,20	35,64

SUPER POLISHED STAINLESS STEEL

AISI 304/1.4301-V2A thermo packed bar length 2,7 LM - Pack. 20 Pcs - 54 LM - 8/10 mm

Article	H mm	€/LM	€/Pc
PQQACML 045	4,5	10,37	28,00
PQQACML 06	6	10,94	29,54
PQQACML 08	8	11,76	31,75
PQQACML 10	10	12,84	34,67
PQQACML 11	11	13,09	35,34
PQQACML 125	12,5	13,30	35,91
PQQACML 15	15	14,94	40,34



COLOURS

(for a precise assessment of colours and finishes, see the relative enclosed sheet)



SUITABLE FOR USE IN CONTACT WITH FOODSTUFFS

CAPSULES, END CAPS and JOINTS for tri-axial joints

POLISHED, SUPER POLISHED and SATINED STAINLESS STEEL AISI 304/1.4301-V2A / PLASTIC



CAPSULE

CPJQAC 045-06-08-10-11-125-15/...
CPJQAC/ML 045-06-08-10-11-125-15/...



JOINT

GIJQ 045-06-08-10-11-125-15/...

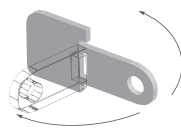

END CAP

TPJQAC/S 045-06-08-10-11-125-15/...

CAPSULES and END CAPS - SATINED STAINLESS STEEL AISI 304/1.4301-V2A

Article	H mm	€/Pc	€/Pack 10 pcs	€/Pack 2 pcs
CPJQACS 045/...	4,5	13,45	134,50	28,24
CPJQACS 06/...	6	13,45	134,50	28,24
CPJQACS 08/...	8	13,45	134,50	28,24
CPJQACS 10/...	10	13,45	134,50	28,24
CPJQACS 11/...	11	13,45	134,50	28,24
CPJQACS 125/...	12,5	13,45	134,50	28,24
CPJQACS 15/...	15	13,45	134,50	28,24
TPJQACS 045-06-08-10-11-125-15/...	4,5-6-8-10-11-125-15	2,26	22,60	4,93

Choose the desired packaging: E.g. CPJQACS .../10 (pack 10 pcs)
CPJQACS .../2 (pack 2 pcs)

JOINTS - PLASTIC

Article	H mm	€/Pc	€/pack. 10 pcs	€/pack. 2 pcs
GIJQ 045/...	4,5	2,16	21,60	4,72
GIJQ 06/...	6	2,16	21,60	4,72
GIJQ 08/...	8	2,16	21,60	4,72
GIJQ 10/...	10	2,16	21,60	4,72
GIJQ 11/...	11	2,16	21,60	4,72
GIJQ 125/...	12,5	2,16	21,60	4,72
GIJQ 15/...	15	2,16	21,60	4,72

Choose the desired packaging: E.g. GIJQ .../10 (pack 10 pcs)
GIJQ .../2 (pack 2 pcs)

CAPSULES and END CAPS - POLISHED STAINLESS STEEL AISI 304/1.4301-V2A

Article	H mm	€/Pc	€/Pack 10 pcs	€/Pack 2 pcs
CPJQAC 045/...	4,5	11,96	119,60	25,16
CPJQAC 06/...	6	11,96	119,60	25,16
CPJQAC 08/...	8	11,96	119,60	25,16
CPJQAC 10/...	10	11,96	119,60	25,16
CPJQAC 11/...	11	11,96	119,60	25,16
CPJQAC 125/...	12,5	11,96	119,60	25,16
CPJQAC 15/...	15	11,96	119,60	25,16
TPJQAC 045-06-08-10-11-125-15/...	4,5-6-8-10-11-125-15	2,26	22,60	4,93

Choose the desired packaging: E.g. CPJQAC .../10 (pack 10 pcs)
CPJQAC .../2 (pack 2 pcs)

CAPSULES - SUPER POLISHED STAINLESS STEEL AISI 304/1.4301-V2A

Article	H mm	€/Pc	€/Pack 10 pcs	€/Pack 2 pcs
CPJQACML 045/...	4,5	14,89	148,90	31,32
CPJQACML 06/...	6	14,89	148,90	31,32
CPJQACML 08/...	8	14,89	148,90	31,32
CPJQACML 10/...	10	14,89	148,90	31,32
CPJQACML 11/...	11	14,89	148,90	31,32
CPJQACML 125/...	12,5	14,89	148,90	31,32
CPJQACML 15/...	15	14,89	148,90	31,32

Choose the desired packaging: E.g. CPJQACML .../10 (pack 10 pcs)
CPJQACML .../2 (pack 2 pcs)

PROJOLLY SQUARE is a square-shaped profile in stainless steel AISI 304 / 1.4301 - V2A, in height 8, 10, 11 or 12.5 mm Two new patterns are available: embossed squares (2,5mm sided) and leather effect. The profile is supplied with a perforated flap that ensures perfect adhesion with the sealant used. The large range of finishes and heights, together with the availability of special pieces such as inside and outside capsules and end caps, make **PROJOLLY SQUARE** an elegant and sought off profile.

PROJOLLY SQUARE

STAINLESS STEEL AISI 304/1.4301-V2A SQUARES / LEATHER EFFECT



STAINLESS STEEL AISI 304/1.4301-V2A SQUARES
bar length 2,7 LM - packaging 40 Pcs - 108 LM
(H 12,5 mm - 54 LM) - 8/10 mm

Article	H mm	€/LM	€/Pc
PJQACQ 08	8	18,25	49,28
PJQACQ 10	10	18,80	50,76
PJQACQ 11	11	19,10	51,57
PJQACQ 125	12,5	19,53	52,79



STAINLESS STEEL AISI 304/1.4301-V2A LEATHER EFFECT - bar length 2,7 LM - packaging 40 Pcs - 108 LM
(H 12,5 mm - 54 LM) - 8/10 mm

Article	H mm	€/LM	€/Pc
PJQACC 08	8	18,25	49,28
PJQACC 10	10	18,80	50,76
PJQACC 11	11	19,10	51,57
PJQACC 125	12,5	19,53	52,79

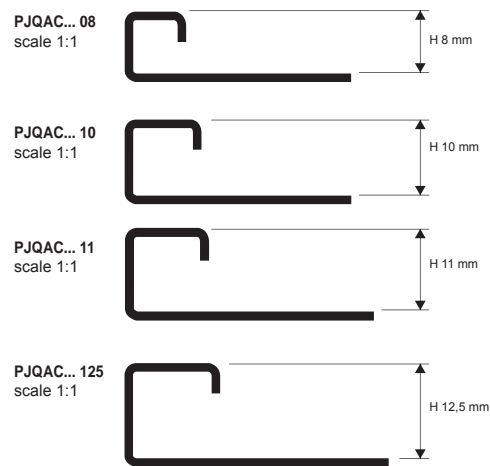

COLOURS



(for a precise assessment of colours and finishes, see the relative enclosed sheet)

CAPSULES and END CAPS - STAINLESS STEEL AISI 304/1.4301-V2A

Article	H mm	€/Pc	€/Pack 10 pcs	€/Pack 2 pcs
CPJQAC 08/...	8			
CPJQAC 10/...	10			
CPJQAC 11/...	11			
CPJQAC 125/...	12,5			
TPJQACM 08-10-11-125/...	8-10-11-12,5			

Choose the desired packaging: E.g. CPJQAC .../10 (pack 10 pcs)
CPJQAC .../2 (pack 2 pcs)

JOINTS - PLASTIC

Article	H mm	€/Pc	€/Pack 10 pcs	€/Pack 2 pcs
GIJQ 08-10-11-125/...	8-10-11-12,5	2,16	21,60	4,72

Choose the desired packaging: E.g. GIJQ .../10 (pack 10 pcs)
GIJQ .../2 (pack 2 pcs)

SUITABLE FOR USE IN CONTACT WITH FOODSTUFFS

PROJOLLY SQUARE is a square shaped as a right angle that is versatile and suitable for various laying solutions, both for floors and coverings. It is used as a staff angle for external corners of tile coverings. It facilitates laying and eliminates the brittle unpredictability of ceramic tiles. It is also used as a finishing square for finishing wall coverings, raised platforms, steps, and baths, and is used as an edge and a skirting board for parquet, natural stone, moquette and epoxy resin coverings. It guarantees flawless work done with care that is of great aesthetic merit. It strengthens tile edges with a square finish, protecting corners efficiently, avoiding chipping and breakages resulting from knocks. This is required by the new European regulations on safety and accident prevention in public and private places.

PROJOLLY SQUARE

POLISHED, STAINLESS STEEL AISI 316L/1.4404-V4A



POLISHED STAINLESS STEEL AISI 316L/1.4404-V4A with protective film - bar length 2,7 LM - packaging 40 Pcs - 108 LM (H 12,5 mm - 54 LM) - 8/10 mm

Article	H mm	€/LM	€/Pc
PJQACM 08	8	11,15	30,11
PJQACM 10	10	11,75	31,73
PJQACM 11	11	12,22	32,99
PJQACM 125	12,5	12,42	33,53

COLOURS



(for a precise assessment of colours and finishes, see the relative enclosed sheet)

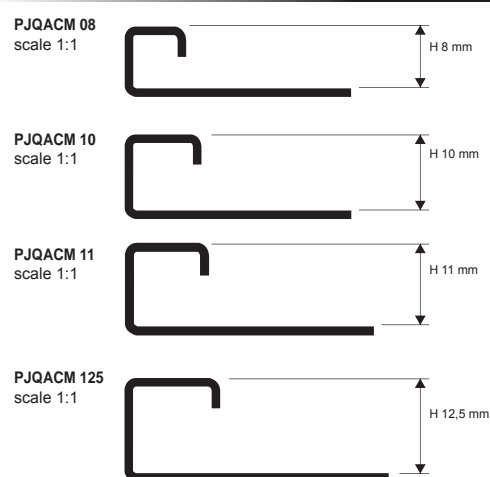

SUITABLE FOR USE IN CONTACT WITH FOODSTUFFS

CAPSULES, END CAPS and JOINTS for tri-axial joints

POLISHED, STAINLESS STEEL AISI 316L / PLASTIC

CAPSULES and END CAPS - POLISHED STAINLESS STEEL AISI 316L/1.4404

Article	H mm	€/Pc	€/Pack 10 pcs	€/Pack 2 pcs
CPJQACM 08/...	8	15,54	155,40	32,63
CPJQACM 10/...	10	15,54	155,40	32,63
CPJQACM 11/...	11	15,54	155,40	32,63
CPJQACM 125/...	12,5	15,54	155,40	32,63
TPJQACM 08-10-11-125/...	8-10-11-12,5	2,93	29,38	5,86

Choose the desired packaging: E.g. CPJQACM .../10 (pack 10 pcs)
CPJQACM .../2 (pack 2 pcs)

JOINTS - PLASTIC

Article	H mm	€/Pc	€/pack. 10 pcs	€/pack. 2 pcs
GIJQ 08/...	8	2,16	21,60	4,72
GIJQ 10/...	10	2,16	21,60	4,72
GIJQ 11/...	11	2,16	21,60	4,72
GIJQ 125/...	12,5	2,16	21,60	4,72

Choose the desired packaging: E.g. GIJQ .../10 (pack 10 pcs)
GIJQ .../2 (pack 2 pcs)

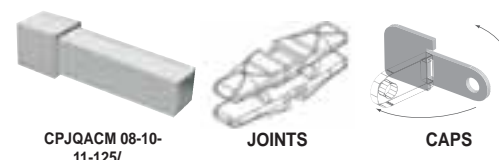



PROJOLLY SQUARE is a square shaped as a right angle that is versatile and suitable for various laying solutions, both for floors and coverings. It is used as a staff angle for external corners of tile coverings. It facilitates laying and eliminates the brittle unpredictability of ceramic tiles. It is also used as a finishing square for finishing wall coverings, raised platforms, steps, and baths, and is used as an edge and a skirting board for parquet, natural stone, moquette and epoxy resin coverings. It guarantees flawless work done with care that is of great aesthetic merit. It strengthens tile edges with a square finish, protecting corners efficiently, avoiding chipping and breakages resulting from knocks. This is required by the new European regulations on safety and accident prevention in public and private places.

PROJOLLY SQUARE

CHROMED BRASS

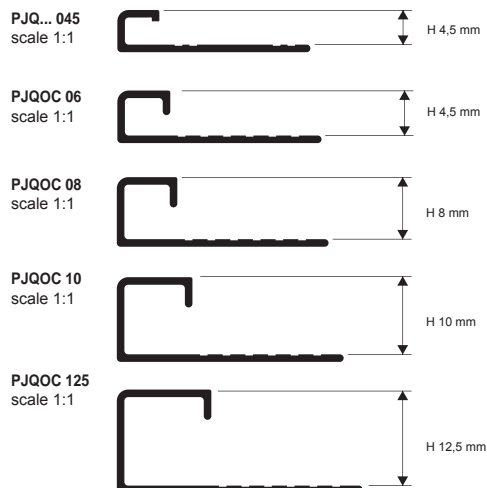

CHROMED BRASS thermo packed
bar length 2,7 LM - packaging 20 Pcs - 54 LM

Article	H mm	€/LM	€/Pcs
PJQOC 045	4,5	14,89	40,20
PJQOC 06	6	16,95	47,77
PJQOC 08	8	20,08	54,22
PJQOC 10	10	21,41	57,81
PJQOC 125	12,5	22,23	60,02

COLOURS

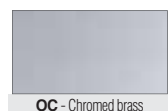

(for a precise assessment of colours and finishes, see the relative enclosed sheet)

LAYING INSTRUCTIONS

1. Choose a PROJOLLY SQUARE height corresponding to the thickness of the covering/floor. 2. Apply the adhesive in the area that the square is being applied. 3. Rest and line up the square, cut to the required length, pressing the perforated tab into the adhesive. 4. Place the tiles lining them up so that the upper part of the square meets with their edge. 5. Fill the contact area between square and tile completely with adhesive to prevent the accumulation of water in the empty spaces. Remove immediately all the remains of grout from the surface of the profile.

IMPORTANT: Pay much attention to the external edges of Projolly in chrome brass. They must be protected against aggressive substances such as adhesives and sealing elements as well as against smoothing and scraping activities.

EXEMPLES OF LAYING

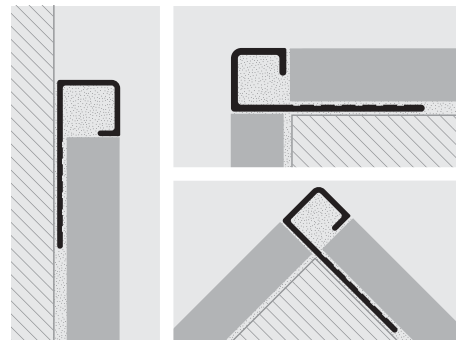

CAPSULES, END CAPS and JOINTS for tri-axial joints

CHROMED BRASS - PLASTIC

CAPSULES and END CAPS - CHROMED BRASS

Article	H mm	€/Pc	€/Pack 10 pcs	€/Pack 2 pcs
CPJQOC 045/...	4,5	11,96	119,60	25,16
CPJQOC 06/...	6	11,96	119,60	25,16
CPJQOC 08/...	8	11,96	119,60	25,16
CPJQOC 10/...	10	11,96	119,60	25,16
CPJQOC 125/...	12,5	11,96	119,60	25,16
TPJQOC 045-06-08-10-125/...	2,26	22,60	4,93	

Choose the desired packaging: E.g. CPJQOC .../10 (pack 10 pcs)
CPJQOC .../2 (pack 2 pcs)

JOINTS - PLASTIC

Article	H mm	€/Pc	€/pack. 10 pcs	€/pack. 2 pcs
GIJQ 045/...	4,5	2,16	21,60	4,72
GIJQ 06/...	6	2,16	21,60	4,72
GIJQ 08/...	8	2,16	21,60	4,72
GIJQ 10/...	10	2,16	21,60	4,72
GIJQ 125/...	12,5	2,16	21,60	4,72

Choose the desired packaging: E.g. GIJQ .../10 (pack 10 pcs)
GIJQ .../2 (pack 2 pcs)



PROJOLLY SQUARE

ANODISED AND POLISHED ALUMINIUM

PROJOLLY SQUARE is a square shaped as a right angle that is versatile and suitable for various laying solutions, both for floors and coverings. It is used as a staff angle for external corners of tile coverings. It facilitates laying and eliminates the brittle unpredictability of ceramic tiles. It is also used as a finishing square for finishing wall coverings, raised platforms, steps, and baths, and is used as an edge and a skirting board for parquet, natural stone, moquette and epoxy resin coverings. It guarantees flawless work done with care that is of great aesthetic merit. It strengthens tile edges with a square finish, protecting corners efficiently, avoiding chipping and breakages resulting from knocks. This is required by the new European regulations on safety and accident prevention in public and private places.

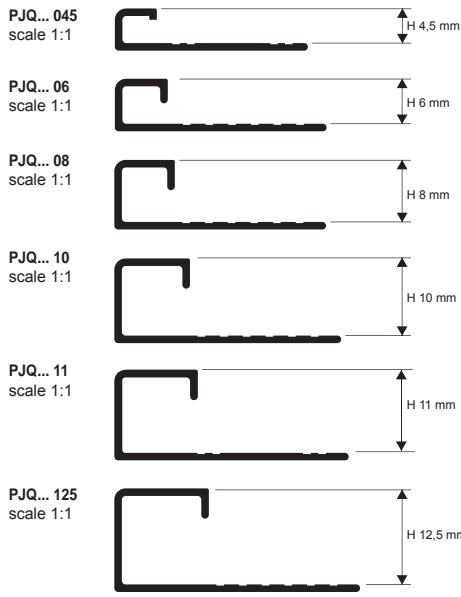

ANODISED ALUMINIUM thermo packed (silver-copper-titanium-black)
bar length 2,7 LM - packaging 40 Pcs - 108 LM

Article	H mm	€/LM	€/Pcs
PJQAA 045 (anod. silver)	4,5	4,31	11,64
PJQAR 045 (anod. copper)	4,5	5,49	14,82
PJQAT 045 (anod. titanium)	4,5	4,52	12,20
PJQAA 06 (anod. silver)	6	4,31	11,64
PJQAR 06 (anod. copper)	6	5,75	15,53
PJQAT 06 (anod. titanium)	6	4,78	12,91
PJQAA 08 (anod. silver)	8	4,35	11,75
PJQAR 08 (anod. copper)	8	5,96	16,09
PJQAT 08 (anod. titanium)	8	4,98	13,45
PJQNE 08 (anod. black)	8	8,25	22,28
PJQAA 10 (anod. silver)	10	4,67	12,61
PJQAR 10 (anod. copper)	10	6,26	16,90
PJQAT 10 (anod. titanium)	10	5,39	14,55
PJQNE 10 (anod. black)	10	8,75	23,63
PJQAA 11 (anod. silver)	11	5,05	13,64
PJQAT 11 (anod. titanium)	11	5,70	15,39
PJQNE 11 (anod. black)	11	10,95	29,57
PJQAA 125 (anod. silver)	12,5	5,34	14,42
PJQAR 125 (anod. copper)	12,5	6,68	18,04
PJQAT 125 (anod. titanium)	12,5	5,96	16,09
PJQNE 125 (anod. black)	12,5	9,75	26,33

POLISHED ALUMINIUM thermo packed (chrome-titanium-copper-black) - bar length - 2,7 LM - packaging 40 Pcs - 108 LM

Article	H mm	€/LM	€/Pcs
PJQBC 045 (polished chrome)	4,5	7,14	19,28
PJQBT 045 (polished titanium)	4,5	7,14	19,28
PJQBR 045 (polished copper)	4,5	7,14	19,28
PJQBC 06 (polished chrome)	6	7,14	19,28
PJQBT 06 (polished titanium)	6	7,14	19,28
PJQBR 06 (polished copper)	6	7,14	19,28
PJQBC 08 (polished chrome)	8	7,19	19,41
PJQBT 08 (polished titanium)	8	7,19	19,41
PJQBR 08 (polished copper)	8	7,19	19,41
PJQBN 08 (polished black)	8	9,25	24,98
PJQBC 10 (polished chrome)	10	7,91	21,36
PJQBT 10 (polished titanium)	10	7,91	21,36
PJQBR 10 (polished copper)	10	7,91	21,36
PJQBN 10 (polished black)	10	9,80	26,46
PJQBC 11 (polished chrome)	11	8,42	22,73
PJQBT 11 (polished titanium)	11	8,42	22,73
PJQBN 11 (polished black)	11	13,10	35,37
PJQBC 125 (polished chrome)	12,5	8,93	24,11
PJQBT 125 (polished titanium)	12,5	8,93	24,11
PJQBR 125 (polished copper)	12,5	8,93	24,11
PJQBN 125 (polished black)	12,5	10,45	28,22

EXAMPLES AND INSTRUCTIONS FOR LAYING METHODS

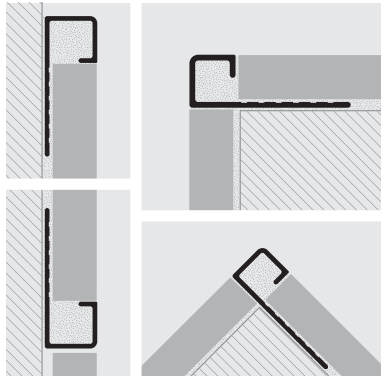

1. Choose a PROJOLLY SQUARE height corresponding to the thickness of the covering/floor. 2. Apply the adhesive in the area that the square is being applied. 3. Rest and line up the square, cut to the required length, pressing the perforated tab into the adhesive. 4. Place the tiles lining them up so that the upper part of the square meets with their edge. 5. Fill the contact area between square and tile completely with adhesive to prevent the accumulation of water in the empty spaces.

IMPORTANT: Pay attention to the external edges of the aluminium Projolly square. They must be protected against agents such as adhesives and sealants and against grinding or scraping actions.

COLOURS

(for a precise assessment of colours and finishes, see the relative enclosed sheet)

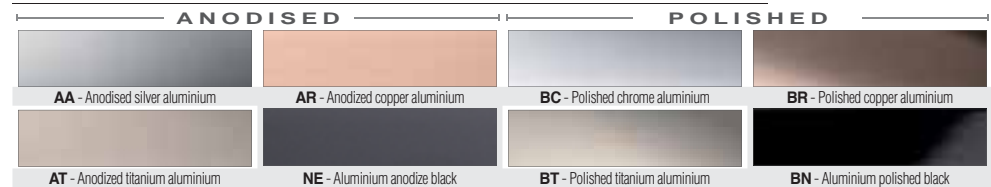

CAPSULES, END CAPS and JOINTS for tri-axial joints

ANODISED and POLISHED ALUMINIUM / PLASTIC

JOINTS - PLASTIC

Article	H mm	€/Pc	€/pack. 10 pcs	€/pack. 2 pcs
GIJQ 045/...	4,5	2,16	21,60	4,72
GIJQ 06/...	6	2,16	21,60	4,72
GIJQ 08/...	8	2,16	21,60	4,72
GIJQ 10/...	10	2,16	21,60	4,72
GIJQ 11/...	11	2,16	21,60	4,72
GIJQ 125/...	12,5	2,16	21,60	4,72

Choose the desired packaging: E.g. GIJQ .../10 (pack 10 pcs)
GIJQ .../2 (pack 2 pcs)



CAPSULE
CPJQ... 045-06-08-10-11-125/...

JOINT
GIJQ 045-06-08
-10-11-125

END CAP
TPJQ... 045-06-08-10-11-125/...

CAPSULES and END CAPS - ANODISED ALUMINIUM

Article	H mm	€/Pc	€/pack. 10 pcs	€/pack. 2 pcs
CPJQAA 045/...	4,5	3,90	39,00	8,73
CPJQAR/AT 045/...	4,5	5,55	55,50	11,81
CPJQAA 06/...	6	3,90	39,00	8,73
CPJQAR/AT 06/...	6	5,55	55,50	11,81
CPJQAA 08/...	8	3,90	39,00	8,73
CPJQAR/AT 08/...	8	5,55	55,50	11,81
CPJQNE 08/...	8	7,22	72,20	15,88
CPJQAA 10/...	10	3,90	39,00	8,73
CPJQAR/AT 10/...	10	5,55	55,50	11,81
CPJQNE 10/...	10	7,22	72,20	15,88
CPJQAA 11/...	11	3,90	39,00	8,73
CPJQAT 11/...	11	5,55	55,50	11,81
CPJQNE 11/...	11	7,22	72,20	15,88
CPJQAA 125/...	12,5	3,90	39,00	8,73
CPJQAR/AT 125/...	12,5	5,55	55,50	11,81
CPJQNE 125/...	12,5	7,22	72,20	15,88
TPJQ... 045-06-08-10-125/...	4,5-6-8-10-12,5	2,26	22,60	4,93

Choose the desired packaging: E.g. CPJQAA .../10 (pack 10 pcs)
CPJQAA .../2 (pack 2 pcs)

CAPSULES and END CAPS - POLISHED ALUMINIUM

Article	H mm	€/Pc	€/pack. 10 pcs	€/pack. 2 pcs
CPJQBC 045/...	4,5	3,90	39,00	8,73
CPJQBR/BT 045/...	4,5	5,55	55,50	11,81
CPJQBC 06/...	6	3,90	39,00	8,73
CPJQBR/BT 06/...	6	5,55	55,50	11,81
CPJQBC 08/...	8	3,90	39,00	8,73
CPJQBR/BT 08/...	8	5,55	55,50	11,81
CPJQBN 08/...	8	7,22	72,20	15,88
CPJQBC 10/...	10	3,90	39,00	8,73
CPJQBR/BT 10/...	10	5,55	55,50	11,81
CPJQBN 10/...	10	7,22	72,20	15,88
CPJQBC 11/...	11	3,90	39,00	8,73
CPJQBT 11/...	11	5,55	55,50	11,81
CPJQBN 11/...	11	7,22	72,20	15,88
CPJQBC 125/...	12,5	3,90	39,00	8,73
CPJQBR/BT 125/...	12,5	5,55	55,50	11,81
CPJQBN 125/...	12,5	7,22	72,20	15,88
TPJQ... 045-06-08-10-125/...	4,5-6-8-10-12,5	2,26	22,60	4,93

Choose the desired packaging: E.g. CPJQBC .../10 (pack 10 pcs)
CPJQBC .../2 (pack 2 pcs)

Prices are referred to whole packs. 10% increase for minimum orders of 10 pcs. 20% increase for orders of less than 10 pcs.

PROJOLLY SQUARE is a square shaped as a right angle that is versatile and suitable for various laying solutions, both for floors and coverings. It is used as a staff angle for external corners of tile coverings. It facilitates laying and eliminates the brittle unpredictability of ceramic tiles. It is also used as a finishing square for finishing wall coverings, raised platforms, steps, and baths, and is used as an edge and a skirting board for parquet, natural stone, moquette and epoxy resin coverings. It guarantees flawless work done with care that is of great aesthetic merit. It strengthens tile edges with a square finish, protecting corners efficiently, avoiding chipping and breakages resulting from knocks. New TILTEX brushed finish.

PROJOLLY SQUARE

POLISHED BRUSHED ALUMINIUM, AND ANODISED BRUSHED TILTEX

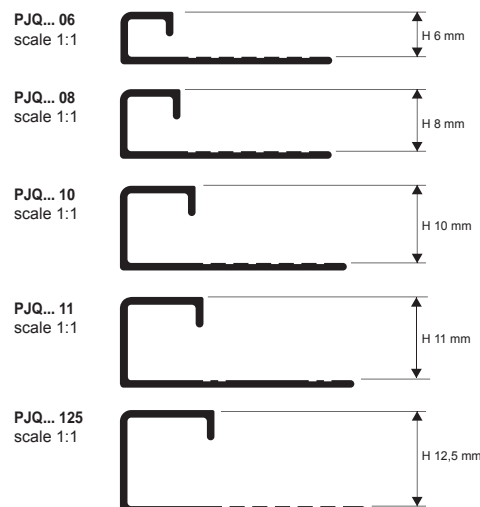

BRUSHED ALUMINIUM thermo packed (silver-copper-titanium-black)
bar length 2,7 LM - packaging 40 Pcs - 108 LM

Article	H mm	€/LM	€/Pc
PJOB5 045 (brush. silver)	4,5	7,75	20,93
PJQRS 045 (brush. copper)	4,5	7,75	20,93
PJQTS 045 (brush. titanium)	4,5	7,75	20,93
PJOB5 06 (brush. silver)	6	8,01	21,63
PJQRS 06 (brush. copper)	6	8,01	21,63
PJQTS 06 (brush. titanium)	6	8,01	21,63
PJOB5 08 (brush. silver)	8	8,11	21,90
PJQRS 08 (brush. copper)	8	8,11	21,90
PJQTS 08 (brush. titanium)	8	8,11	21,90
PJOB5 10 (brush. silver)	10	8,73	23,57
PJQRS 10 (brush. copper)	10	8,73	23,57
PJQTS 10 (brush. titanium)	10	8,73	23,57
PJOB5 11 (brush. silver)	11	9,25	24,98
PJQRS 11 (brush. copper)	11	9,25	24,98
PJQTS 11 (brush. titanium)	11	9,25	24,98
PJOB5 125 (brush. silver)	12,5	9,86	26,62
PJQRS 125 (brush. copper)	12,5	9,86	26,62
PJQTS 125 (brush. titanium)	12,5	9,86	26,62
PJOB5 125 (brush. black)	12,5	11,35	30,65
PJOB5 11 (brush. silver)	11	9,25	24,98
PJQRS 11 (brush. copper)	11	9,25	24,98
PJQTS 11 (brush. titanium)	11	9,25	24,98
PJOB5 125 (brush. silver)	12,5	9,86	26,62
PJQRS 125 (brush. copper)	12,5	9,86	26,62
PJQTS 125 (brush. titanium)	12,5	9,86	26,62
PJOB5 125 (brush. black)	12,5	12,82	34,61

ANOD. BRUSHED TILTEX ALUMINIUM thermo packed (silver-copper and titanium) - bar length 2,7 LM - packaging 40 Pcs - 108 LM

Article	H mm	€/LM	€/Pc
PJOBX 06 (silver TILTEX)	6	9,14	24,68
PJQRX 06 (copper TILTEX)	6	9,14	24,68
PJQTX 06 (titanium TILTEX)	6	9,14	24,68
PJOBX 08 (silver TILTEX)	8	10,22	27,59
PJQRX 08 (copper TILTEX)	8	10,22	27,59
PJQTX 08 (titanium TILTEX)	8	10,22	27,59
PJOBX 10 (silver TILTEX)	10	10,94	29,54
PJQRX 10 (copper TILTEX)	10	10,94	29,54
PJQTX 10 (titanium TILTEX)	10	10,94	29,54
PJOBX 11 (silver TILTEX)	11	11,50	31,05
PJQRX 11 (copper TILTEX)	11	11,50	31,05
PJQTX 11 (titanium TILTEX)	11	11,50	31,05
PJOBX 125 (silver TILTEX)	12,5	12,12	32,72
PJQRX 125 (copper TILTEX)	12,5	12,12	32,72
PJQTX 125 (titanium TILTEX)	12,5	12,12	32,72

EXAMPLES AND INSTRUCTIONS FOR LAYING METHODS

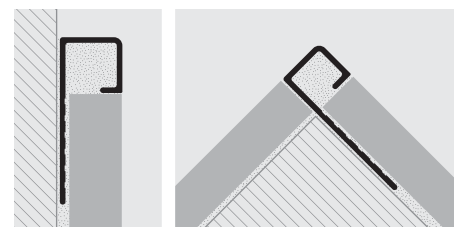

1. Choose a PROJOLLY SQUARE height corresponding to the thickness of the covering/floor. 2. Apply the adhesive in the area that the square is being applied. 3. Rest and line up the square, cut to the required length, pressing the perforated tab into the adhesive. 4. Place the tiles lining them up so that the upper part of the square meets with their edge. 5. Fill the contact area between square and tile completely with adhesive to prevent the accumulation of water in the empty spaces.

IMPORTANT: Pay attention to the external edges of the aluminium Projolly square. They must be protected against agents such as adhesives and sealants and against grinding or scraping actions.

COLOURS

(for a precise assessment of colours and finishes, see the relative enclosed sheet)



CAPSULES, END CAPS and JOINTS for tri-axial joints

ANODISED BRUSHED POLISHED ALUMINIUM, TILTEX / PLASTIC

CAPSULES and END CAPS - POLISHED BRUSHED ALUMINIUM

Article	H mm	€/Pc	€/pack. 10 pcs	€/pack. 2 pcs
CPJQ... 045/...	4,5	5,50	55,50	11,81
CPJQ... 06/...	6	5,50	55,50	11,81
CPJQ... 08/...	8	5,50	55,50	11,81
CPJQ... 10/...	10	5,50	55,50	11,81
CPJQ... 11/...	11	5,50	55,50	11,81
CPJQ... 125/...	12,5	5,50	55,50	11,81
CPJQNS 08-10-11-125/...	8-10-11-12,5	7,15	71,50	15,73
TPJQ... 045-06-08-10-11-125/...	4,5-6-8-10-12,5	2,26	22,60	4,93

Available in the finishes: BS - RS - TS - NS.
The code of the selected colour must be added to the article code.
E.g.: CPJQ... 08/... (chosen finish Brushed Copper)
CPJQRS 08/2.

CAPSULES and END CAPS - ANOD. BRUSHED ALU. - TILTEX

Article	H mm	€/Pc	€/pack. 10 pcs	€/pack. 2 pcs
CPJQ... 06/...	6	7,29	72,90	15,30
CPJQ... 08/...	8	7,29	72,90	15,30
CPJQ... 10/...	10	7,29	72,90	15,30
CPJQ... 11/...	11	7,29	72,90	15,30
CPJQ... 125/...	12,5	7,29	72,90	15,30
TPJQ... 06-08-10-11-125/...	6-8-10-11-12,5	2,26	22,60	4,93

Available in the finishes: BX - RX - TX.
The code of the selected colour must be added to the article code.
E.g.: CPJQ... 08/... (chosen finish Brushed Copper)
CPJQRX 08/10.

JOINTS - PLASTIC

Article	H mm	€/Pc	€/pack. 10 pcs	€/pack. 2 pcs
GIJQ 045/...	4,5	2,16	21,60	4,72
GIJQ 06/...	6	2,16	21,60	4,72
GIJQ 08/...	8	2,16	21,60	4,72
GIJQ 10/...	10	2,16	21,60	4,72
GIJQ 11/...	11	2,16	21,60	4,72
GIJQ 125/...	12,5	2,16	21,60	4,72

Choose the desired packaging: E.g. GIJQ .../10 (pack 10 pcs)
GIJQ .../2 (pack 2 pcs)



* = CPJQRS 045 - 06 - 08 - 125 Upon request, price and delivery time to be agreed.
* = CPJQRX 06 - 08 - 10 - 125 Upon request, price and delivery time to be agreed.

Prices are referred to whole packs. 10% increase for minimum orders of 10 pcs. 20% increase for orders of less than 10 pcs.

PROJOLLY SQUARE

VARNISHED ALUMINIUM

PROJOLLY SQUARE is a square shaped as a right angle that is versatile and suitable for various laying solutions, both for floors and coverings. It is used as a staff angle for external corners of tile coverings. It facilitates laying and eliminates the brittle unpredictability of ceramic tiles. It is also used as a finishing square for finishing wall coverings, raised platforms, steps, and baths, and is used as an edge and a skirting board for parquet, natural stone, moquette and epoxy resin coverings. It guarantees flawless work done with care that is of great aesthetic merit. It strengthens tile edges with a square finish, protecting corners efficiently, avoiding chipping and breakages resulting from knocks.

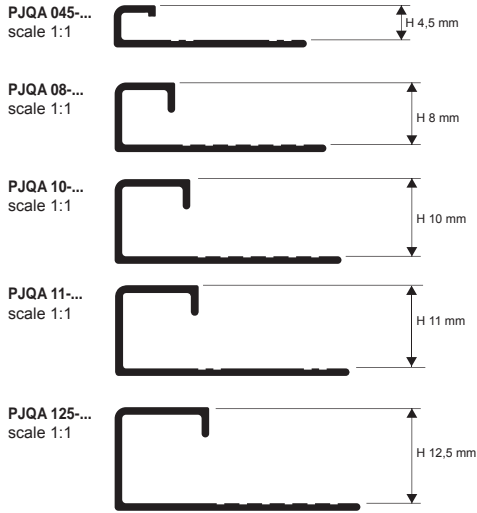

VARNISHED ALUMINIUM thermo packed
bar length 2,7 LM - Pack. 20 Pcs-54 LM (White colour 108 LM)

Article	H mm	€/LM	€/Pc
PJQA 045-01 (white varnished)	4,5	5,08	13,72
PJQA 08-...	8	5,24	14,15
PJQA 10-...	10	5,65	15,26
PJQA 11-01 (white varnished)	11	5,90	15,93
PJQA 125-01 (white varnished)	12,5	6,16	16,63

TUSCANY LINE AND CREPE' thermo packed
bar length 2,7 LM - packaging 40 Pcs - 108 LM

Article	H mm	€/LM	€/Pc
PJQA 08-...	8	15,50	41,85
PJQA 10-...	10	15,80	42,66
PJQA 125-...	12,5	16,16	43,61

Available in the finishes: 03TU - 05TU - 20TU - CR.
The code of the selected colour must be added to the article code.
E.g.: PJQA 08-... (chosen finish 03TU-Tuscany grey)
PJQA 08-03TU.

EXAMPLES AND INSTRUCTIONS FOR LAYING METHODS

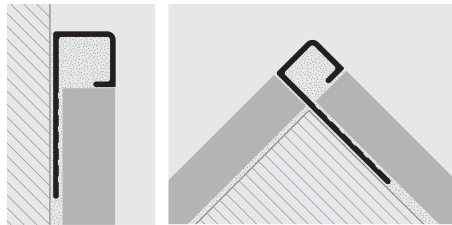

1. Choose a PROJOLLY SQUARE height corresponding to the thickness of the covering/floor. 2. Apply the adhesive in the area that the square is being applied. 3. Rest and line up the square, cut to the required length, pressing the perforated tab into the adhesive. 4. Place the tiles lining them up so that the upper part of the square meets with their edge. 5. Fill the contact area between square and tile completely with adhesive to prevent the accumulation of water in the empty spaces. **IMPORTANT:** Pay attention to the external edges of the aluminium Projolly square. They must be protected against agents such as adhesives and sealants and against grinding or scraping actions.

0106 - 02 - 03 - 0211 - 0311 - 06 - 10 - 11 - 17 available upon request with a minimum quantity order of 540 LM.

COLOURS

(for a precise assessment of colours and finishes, see the relative enclosed sheet)

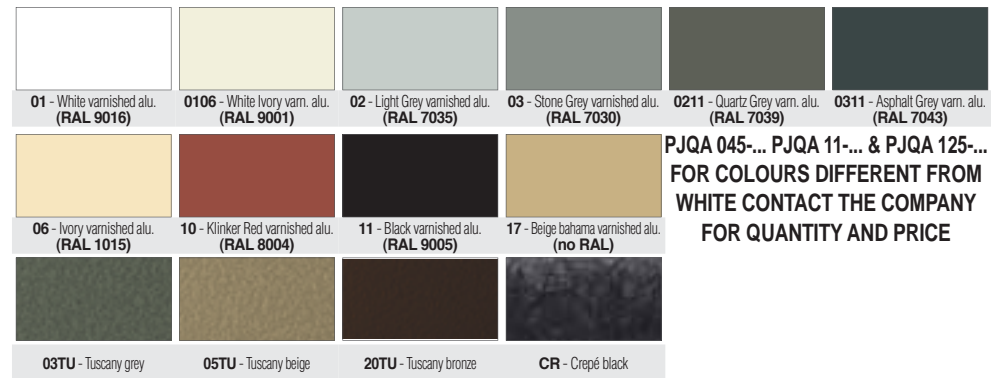

**PJQA 045-... PJQA 11-... & PJQA 125-...
FOR COLOURS DIFFERENT FROM
WHITE CONTACT THE COMPANY
FOR QUANTITY AND PRICE**

© 2011 All rights reserved by Progress Profiles. Printed in Italy

CAPSULES, END CAPS and JOINTS for tri-axial joints

VARNISHED ALUMINIUM / PLASTIC

JOINTS - PLASTIC

Article	H mm	€/Pc	€/pack. 10 pcs	€/pack. 2 pcs
GIJQ 045/...	4,5	2,16	21,60	4,72
GIJQ 08/...	8	2,16	21,60	4,72
GIJQ 10/...	10	2,16	21,60	4,72
GIJQ 11/...	11	2,16	21,60	4,72
GIJQ 125/...	12,5	2,16	21,60	4,72

Choose the desired packaging: E.g. GIJQ .../10 (pack 10 pcs)
GIJQ .../2 (pack 2 pcs)



CAPSULES and END CAPS - VARNISHED ALUMINIUM

Article	H mm	€/Pc	€/pack. 10 pcs	€/pack. 2 pcs
CPJQA 045-01/...	4,5	4,01	40,10	8,73
CPJQA 08-.../...	8	4,01	40,10	8,73
CPJQA 10-.../...	10	4,01	40,10	8,73
CPJQA 11-01/...	11	4,01	40,10	8,73
CPJQA 125-01/...	12,5	4,01	40,10	8,73
TPJQA 045/08/10/125 .../...	8-10-12,5	2,26	22,60	4,93

Available upon request: 0106 - 02 - 03 - 0211 - 0311 - 06 - 10 - 11 - 17.
The code of the selected colour must be added to the article code.
E.g.: CPJQA .../... (chosen finish BIANCO AVORIO)
CPJQA 08-0106/10

CAPSULES - TUSCANY LINE/ CREPE'

Article	H mm	€/Pc	€/pack. 10 pcs	€/pack. 2 pcs
CPJQA 08-.../...	8	12,00	120,00	25,20
CPJQA 10-.../...	10	12,00	120,00	25,20
CPJQA 125-.../...	12,5	12,00	120,00	25,20

Available in the finishes: 03TU - 05TU - 20TU - CR.
The code of the selected colour must be added to the article code.
E.g.: CPJQA .../... (chosen finish GRIGIO TUSCANY)
CPJQA 08-03UT/10

The **PROJOLLY SQUARE**, available IN 18 COLOURS, with EAN BAR CODE, facilitates installation, eliminating the fragile ceramic trim. It is used for outside corners of tiles to complete the finish of wall coverings, decking, steps, bathtubs, etc. Impeccable, precise work is ensured with a superior aesthetic effect. It strengthens the tile edge, thereby preventing chipping and breakages. It is made in certificated impact-resistant non-toxic PVC. Required by European standards for safety and hygiene in public and private environments. End caps and three-way inside and outside corner linking elements are available.

PROJOLLY SQUARE

NON-TOXIC, IMPACT-RESISTANT
COLOURED VINYL RESIN



NON-TOXIC IMPACT-RESISTANT VINYL RESIN
bar length 2,7 LM - Pack. 54 LM (colour white Pack. 108 LM)

Article	H mm	€/LM	€/Pc
PJQ 06-...	6	1,01	2,73
PJQ 08-...	8	1,06	2,86
PJQ 10-...	10	1,15	3,11
PJQ 125-...	12,5	1,25	3,38

Available in the colours: 01-02-03-04-05-06-07-08-09-10-11-12-13-14-15-16-17-18-0106 (19-20-21-22-23-24-25-26-27-28-29 available upon request with a minimum quantity order of 5400 LM).
The code of the selected colour must be added to the article code.
E.g.: PJQ 08... (chosen colour White) PJQ 08-01.

WHITE NOT FOR SALE SINGLY

1. Choose a PROJOLLY SQUARE height corresponding to the thickness of the covering/floor.
2. Apply the adhesive in the area that the square is being applied.
3. Rest and line up the square, cut to the required length, pressing the perforated tab into the adhesive.
4. Place the tiles lining them up so that the upper part of the square meets with their edge.
5. Fill the contact area between square and tile completely with adhesive to prevent the accumulation of water in the empty spaces.

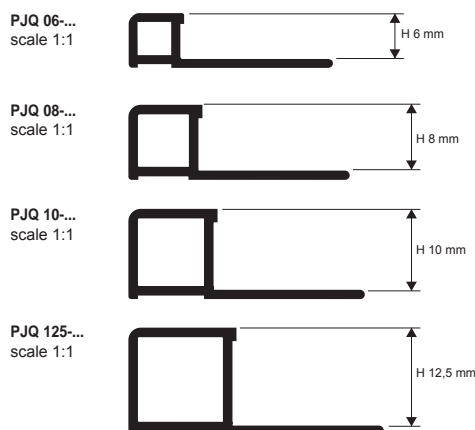

EXAMPLES AND INSTRUCTIONS FOR LAYING METHODS

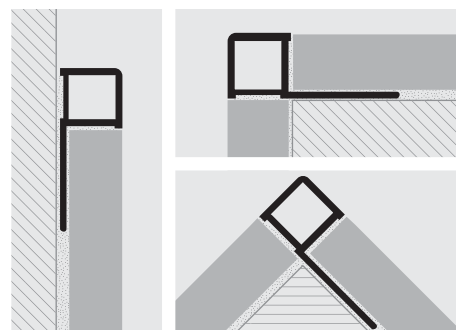

AVAILABLE minimum quantity 5400 LM by colour and height
(price and delivery time to be agreed)

COLOURS

(for a precise assessment of colours and finishes, see the relative enclosed sheet)

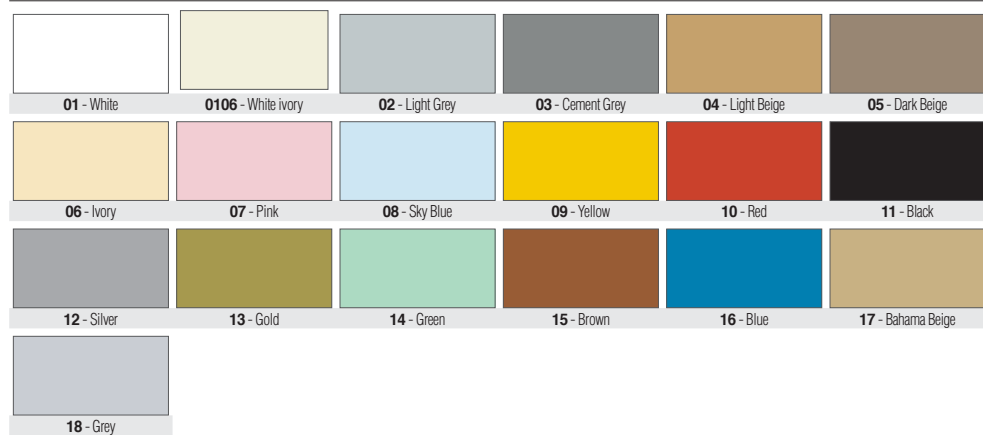

© 2011 All rights reserved by Progress Profiles. Printed in Italy

CAPSULES and tri-axial joints

POLYPROPYLENE/POLYETYLENE UV RESISTANT



POLYPROPYLENE/POLYETYLENE UV RESISTANT

Article	H mm	€/Pc	€/pack. 20 pcs	€/pack. 5 pcs
CPJQ 06-.../...	6	0,84	16,80	5,03
CPJQ 08-.../...	8	0,86	17,20	5,03
CPJQ 10-.../...	10	0,88	17,60	5,03
CPJQ 125-.../...	12,5	0,91	18,20	5,03

Available in the colours: 01-02-03-04-05-06-07-08-09-10-11-12-13-14-15-16-17-18-0106 (19-20-21-22-23-24-25-26-27-28-29 available upon request).

The code of the selected colour must be added to the article code.
E.g.: CPJQ 08-.../... (chosen colour White, 5 pcs) CPJQ 08-01/5.



POLYPROPYLENE/POLYETYLENE UV RESISTANT

Article	H mm	€/Pc	€/pack. 20 pcs	€/pack. 5 pcs
IPJQ 06-.../...	6	0,84	16,80	5,03
IPJQ 08-.../...	8	0,86	17,20	5,03
IPJQ 10-.../...	10	0,88	17,60	5,03
IPJQ 125-.../...	12,5	0,91	18,20	5,03

PROJOLLY QUART

POLISHED, SUPER POLISHED AND SATINED STAINLESS STEEL AISI 304/1.4301-V2A

PROJOLLY QUART has been designed and conceived in still more squared form, with "a quarter" of circle shape, in order to offer an alternative to **PROJOLLY SQUARE** and **PROJOLLY** as well. It facilitates the laying process eliminating the fragile ceramic corner tiles. It's used for the external corners of the tiles, in order to terminate the finishing of wall coverings, for platforms, stair steps, bathtubs, etc. It guarantees the impeccable work, ensuring considerable aesthetic effect as well. Thanks to the round finishing it strengthens the tile edge avoiding their chipping and breakages. Required by new European regulations on safety and accident prevention in public and private places. Available in capsules and three-axial joints for internal and external angles, end caps and joints. Chromatic combining with **PROLISTEL** panelist in aisi 304/1.4301-V2A glossy, super polished or glazed stainless steel recommended. Besides the **PROFINLIST** and **PROLISTEL** aluminium panelists available in many finishing versions.

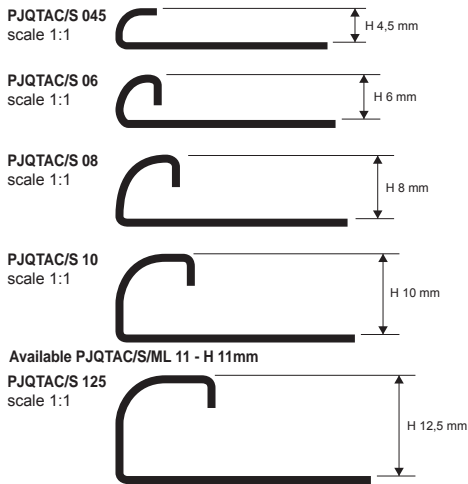

POLISHED STAINLESS STEEL AISI 304/1.4301-V2A with protective film - bar length 2,7 LM - packaging 40 Pcs - 108 LM (H 10-11mm - 81 LM; H 12,5 mm - 54 LM) - 10/10

Article	H mm	€/LM	€/Pc
PJQTAC 045	4,5	8,52	23,00
PJQTAC 06	6	9,29	25,08
PJQTAC 08	8	9,91	26,76
PJQTAC 10	10	10,68	28,84
PJQTAC 11	11	11,10	29,97
PJQTAC 125	12,5	11,45	30,92

SATINED STAINLESS STEEL AISI 304/1.4301-V2A - with protective film bar length 2,7 LM - packaging 40 Pcs - 108 LM (H 10-11mm - 81 LM H 12,5 mm - 54 LM) - 10/10 mm

Article	H mm	€/LM	€/Pc
PJQTACS 045	4,5	10,73	28,97
PJQTACS 06	6	11,14	30,08
PJQTACS 08	8	11,81	31,89
PJQTACS 10	10	12,63	34,10
PJQTACS 11	11	13,00	35,10
PJQTACS 125	12,5	13,30	35,91

EXAMPLES AND INSTRUCTIONS FOR LAYING METHODS

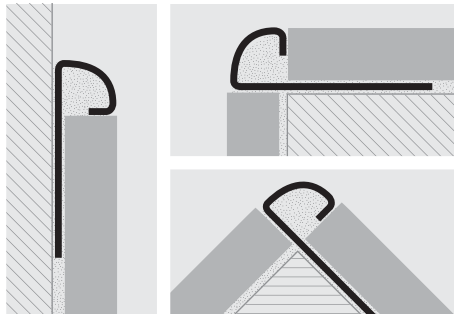

1. Choose the PROJOLLY QUART with suitable height for the thickness of the covering. 2. Apply the adhesive onto the area of application of the profile. 3. Lay and align the profile, cut to the necessary length, pressing the perforated flange into the adhesive. 4. Lay the tiles, aligning them so that the top edge of the profile is flush with the tile. 5. Fill the profile/tile area of contact with adhesive to prevent the accumulation of water in any voids.

SUPER POLISHED STAINLESS STEEL AISI 304/1.4301-V2A thermo packed bar length 2,7 LM - packaging 20 Pcs - 54 LM - 10/10 mm

Article	H mm	€/LM	€/Pc
PJQTACML 045	4,5	10,37	28,00
PJQTACML 06	6	11,61	31,35
PJQTACML 08	8	12,22	32,99
PJQTACML 10	10	12,99	35,07
PJQTACML 11	11	13,40	36,18
PJQTACML 125	12,5	13,71	37,02

COLOURS



(for a precise assessment of colours and finishes, see the relative enclosed sheet)

SUITABLE FOR USE IN CONTACT WITH FOODSTUFFS

CAPSULES, END CAPS and JOINTS for tri-axial joints

POLISHED, SUPER POLISHED and SATINED STAINLESS STEEL AISI 304/1.4301-V2A / PLASTIC

CAPSULES and END CAPS - POLISHED STAINLESS STEEL AISI 304/1.4301-V2A

Article	H mm	€/Pc	€/pack. 10 pcs	€/pack. 2 pcs
CPJQTAC 045/... (outside)	4,5	10,94	109,40	24,13
IPJQTAC 045/... (inside)	4,5	10,94	109,40	24,13
CPJQTAC 06/... (outside)	6	11,40	114,00	25,68
IPJQTAC 06/... (inside)	6	11,40	114,00	25,68
CPJQTAC 08/... (outside)	8	11,91	119,10	26,14
IPJQTAC 08/... (inside)	8	11,91	119,10	26,14
CPJQTAC 10/... (outside)	10	12,73	127,30	26,70
IPJQTAC 10/... (inside)	10	12,73	127,30	26,70
CPJQTAC 11/... (outside)	11	13,35	133,50	27,73
IPJQTAC 11/... (inside)	11	13,35	133,50	27,73
CPJQTAC 125/... (outside)	12,5	13,86	138,60	28,76
IPJQTAC 125/... (inside)	12,5	13,86	138,60	28,76
TPJQTAC 045-06-08-10-125/...	4,5-6-8-10-12,5	2,26	22,60	4,93

Choose the desired packaging: E.g. CPJQTAC .../10 (pack 10 pcs)
 CPJQTAC .../2 (pack 2 pcs)

CAPSULES and CAPS - SATINED STAINLESS STEEL AISI 304/1.4301-V2A

Article	H mm	€/Pc	€/pack. 10 pcs	€/pack. 2 pcs
CPJQTACS 045/... (outside)	4,5	12,73	127,30	27,73
IPJQTACS 045/... (inside)	4,5	12,73	127,30	27,73
CPJQTACS 06/... (outside)	6	12,84	128,40	28,24
IPJQTACS 06/... (inside)	6	12,84	128,40	28,24
CPJQTACS 08/... (outside)	8	12,94	129,40	28,76
IPJQTACS 08/... (inside)	8	12,94	129,40	28,76
CPJQTACS 10/... (outside)	10	13,76	137,60	29,27
IPJQTACS 10/... (inside)	10	13,76	137,60	29,27
CPJQTACS 11/... (outside)	11	14,25	142,50	30,04
IPJQTACS 11/... (inside)	11	14,25	142,50	30,04
CPJQTACS 125/... (outside)	12,5	14,69	146,90	30,81
IPJQTACS 125/... (inside)	12,5	14,69	146,90	30,81
TPJQTACS 045-06-08-10-125/...	4,5-6-8-10-12,5	2,26	22,60	4,93

Choose the desired packaging.
 E.g. CPJQTACS .../10 (pack 10 pcs)
 CPJQTACS .../2 (pack 2 pcs)

CAPSULES - SUPER POLISHED STAINLESS STEEL AISI 304/1.4301-V2A

Article	H mm	€/Pc	€/pack. 10 pcs	€/pack. 2 pcs
CPJQTACML 045/... (outside)	4,5	12,73	127,30	27,73
IPJQTACML 045/... (inside)	4,5	12,73	127,30	27,73
CPJQTACML 06/... (outside)	6	12,84	128,40	28,24
IPJQTACML 06/... (inside)	6	12,84	128,40	28,24
CPJQTACML 08/... (outside)	8	12,94	129,40	28,76
IPJQTACML 08/... (inside)	8	12,94	129,40	28,76
CPJQTACML 10/... (outside)	10	13,76	137,60	29,27
IPJQTACML 10/... (inside)	10	13,76	137,60	29,27
CPJQTACML 11/... (outside)	11	14,25	142,50	30,04
IPJQTACML 11/... (inside)	11	14,25	142,50	30,04
CPJQTACML 125/... (outside)	12,5	14,69	146,90	30,81
IPJQTACML 125/... (inside)	12,5	14,69	146,90	30,81

Choose the desired packaging.
 E.g. CPJQTACML .../10 (pack 10 pcs)
 CPJQTACML .../2 (pack 2 pcs)

JOINTS - PLASTIC

Article	H mm	€/Pc	€/pack. 10 pcs	€/pack. 2 pcs
GIJQT 045/...	4,5	2,16	21,60	4,72
GIJQT 06/...	6	2,16	21,60	4,72
GIJQT 08/...	8	2,16	21,60	4,72
GIJQT 10/...	10	2,16	21,60	4,72
GIJQT 11/...	11	2,16	21,60	4,72
GIJQT 125/...	12,5	2,16	21,60	4,72

Choose the desired packaging: E.g. GIJQT .../10 (pack 10 pcs)
 GIJQT .../2 (pack 2 pcs)

END CAP
 TPJQTAC/S 045-06-08-10-11-125



JOINT
 GIJQT 045-06-08-10-11-125



OUTSIDE CAPSULES



CPJQTAC.. 045-06-08-10-11-125/...

INSIDE CAPSULES



IPJQTAC.. 045-06-08-10-11-125/...

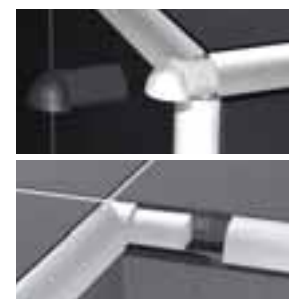

PROJOLLY QUART in anodised aluminium (silver, titanium and gold), polished aluminium (chrome, titanium and gold). **PROJOLLY QUART** is a rounded profile conceived to protect the external corners of wall coverings and to cover perimeter joints. The special quarter-of-circle shape of this profile, together with the range of finishes available and completing elements, such as inside/outside capsules and end caps make it a requested product, that can be used with any kind of wall and floor covering. Remove immediately the remains of glue or sealant from the profile surface, once the profile has been laid, otherwise this substances could lead to the formation of aluminium hydroxide, causing dark indelible stains on the profile surface.

PROJOLLY QUART

ANODISED ALUMINIUM
POLISHED ALUMINIUM



ANODISED ALUMINIUM (silver-titanium-gold)
thermo packed - bar length 2,7 LM - Pack. 40 Pcs - 108 LM
(for H 15 silver ANODISED ALU. Pack. 20 Pcs - 54 LM)

Articolo	H mm	€/LM	€/Pc
PJQTAA 06 (anod. silver)	6	4,01	10,83
PJQTAO 06 (anod. gold)	6	4,01	10,83
PJQTAA 08 (anod. silver)	8	4,26	11,50
PJQTAO 08 (anod. gold)	8	4,26	11,50
PJQTAT 08 (anod. titanium)	8	4,71	12,72
PJQTAA 10 (anod. silver)	10	4,60	12,42
PJQTAO 10 (anod. gold)	10	4,60	12,42
PJQTAT 10 (anod. titanium)	10	5,12	13,82
PJQTAA 11 (anod. silver)	11	4,90	13,23
PJQTAO 11 (anod. gold)	11	4,90	13,23
PJQTAT 11 (anod. titanium)	11	5,40	14,58
PJQTAA 125 (anod. silver)	12,5	5,19	14,01
PJQTAO 125 (anod. gold)	12,5	5,19	14,01
PJQTAT 125 (anod. titanium)	12,5	5,76	15,55
PJQTAA 15 (anod. silver)	15	5,80	15,66

POLISHED ALUMINIUM (chrome-titanium-gold)
thermo packed - bar length 2,7 LM - Pack. 40 Pcs - 108 LM
(H 15 mm - 54 LM)

Articolo	H mm	€/LM	€/Pc
PJQTBC 06 (polish. chrome)	6	6,52	17,60
PJQTBO 06 (polish. gold)	6	6,52	17,60
PJQTBC 08 (polish. chrome)	8	7,03	18,98
PJQTBO 08 (polish. gold)	8	7,03	18,98
PJQTBT 08 (polish. titanium)	8	7,03	18,98
PJQTBC 10 (polish. chrome)	10	7,81	21,09
PJQTBO 10 (polish. gold)	10	7,81	21,09
PJQTBT 10 (polish. titanium)	10	7,81	21,09
PJQTBC 11 (polish. chrome)	11	8,30	22,41
PJQTBO 11 (polish. gold)	11	8,30	22,41
PJQTBT 11 (polish. titanium)	11	8,30	22,41
PJQTBC 125 (polish. chrome)	12,5	8,83	23,84
PJQTBO 125 (polish. gold)	12,5	8,83	23,84
PJQTBT 125 (polish. titanium)	12,5	8,83	23,84
PJQTBC 15 (polish. chrome)	15	9,61	25,95

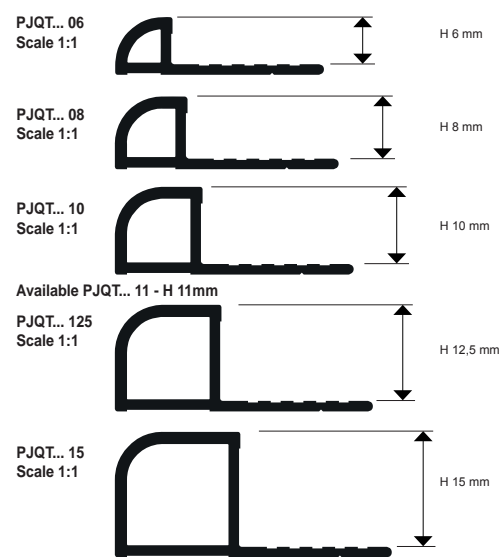

EXAMPLES AND INSTRUCTIONS FOR LAYING METHODS

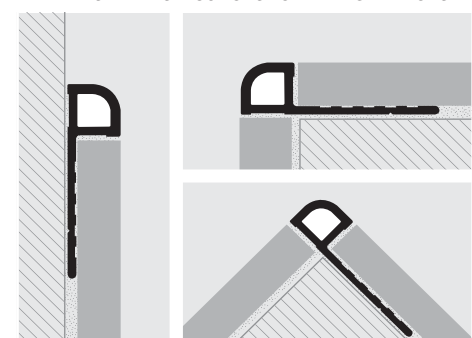

1. Choose PROJOLLY QUART in the desired finish and in the required height, according to the thickness of the tile; 2. Cut PROJOLLY QUART to the desired length and apply the adhesive on the area where the profile will be installed; 3. Press the anchoring flange of PROJOLLY QUART into the adhesive; 4. Lay the tiles and align them, so that the top edge of the profile is flush with the tile, leaving a 2mm joint. Remove immediately the remains of adhesive from the profile surface; 5. Fill the joints between the profile and the tiles with sealant, in order to avoid water stagnation. Remove immediately the remains of sealant from the profile surface.

COLOURS

(for a precise assessment of colours and finishes, see the relative enclosed sheet)

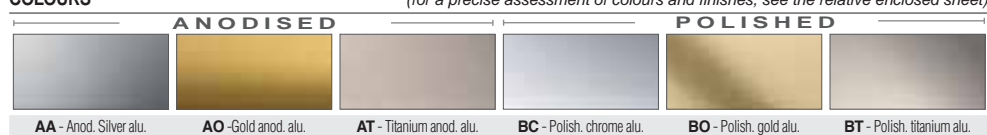

UPON REQUEST MAY BE REALISED IN OTHER FINISHES OF THE COLOUR CHART.
CONTACT OUR CUSTOMER SERVICE FOR MINIMUM QUANTITY, TIMING AND PRICE.

CAPSULES, END CAPS & JOINTS/CONNECTOR for tri-axial joints

ANODISED, POLISHED ALUMINIUM, PLASTIC

LEFT CAPSULES and END CAPS - ANODISED ALUMINIUM

Article	H mm	€/Pc	€/Pack 10 pcs	€/Pack 2 pcs
CPJQTAA/AO 06/... (outside)	6	2,77	27,70	6,11
IPJQTAA/AO 06/... (inside)	6	2,77	27,70	6,11
CPJQTAA/AO 08/... (outside)	8	2,77	27,70	6,11
IPJQTAA/AO 08/... (inside)	8	2,77	27,70	6,11
CPJQTAT 08/... (outside)	8	4,93	49,30	11,30
IPJQTAT 08/... (inside)	8	4,93	49,30	11,30
CPJQTAA/AO 10/... (outside)	10	2,77	27,70	6,11
IPJQTAA/AO 10/... (inside)	10	2,77	27,70	6,11
CPJQTAT 10/... (outside)	10	4,93	49,30	11,30
IPJQTAT 10/... (inside)	10	4,93	49,30	11,30
CPJQTAA/AO 11/... (outside)	11	2,77	27,70	6,11
IPJQTAA/AO 11/... (inside)	11	2,77	27,70	6,11
CPJQTAT 11/... (outside)	11	4,93	49,30	11,30
IPJQTAT 11/... (inside)	11	4,93	49,30	11,30
CPJQTAA/AO 125/... (outside)	12,5	2,77	27,70	6,11
IPJQTAA/AO 125/... (inside)	12,5	2,77	27,70	6,11
CPJQTAT 125/... (outside)	12,5	4,93	49,30	11,30
IPJQTAT 125/... (inside)	12,5	4,93	49,30	11,30
CPJQTAA 15/... (outside)	15	3,29	32,90	7,24
IPJQTAA 15/... (inside)	15	3,54	35,40	7,24
TPJQT... 06-08-10-11-125-15/...		2,26	22,60	4,93

LEFT CAPSULES and END CAPS - POLISHED ALUMINIUM

Article	H mm	€/Pc	€/Pack 10 pcs	€/Pack 2 pcs
CPJQTBC/BO 06/... (outside)	6	2,77	27,70	6,11
IPJQTBC/BO 06/... (inside)	6	2,77	27,70	6,11
CPJQTBC/BO 08/... (outside)	8	2,77	27,70	6,11
IPJQTBC/BO 08/... (inside)	8	2,77	27,70	6,11
CPJQTBT 08/... (outside)	8	4,93	49,30	11,30
IPJQTBT 08/... (inside)	8	4,93	49,30	11,30
CPJQTBC/BO 10/... (outside)	10	2,77	27,70	6,11
IPJQTBC/BO 10/... (inside)	10	2,77	27,70	6,11
CPJQTBT 10/... (outside)	10	4,93	49,30	11,30
IPJQTBT 10/... (inside)	10	4,93	49,30	11,30
CPJQTBC/BO 11/... (outside)	11	2,77	27,70	6,11
IPJQTBC/BO 11/... (inside)	11	2,77	27,70	6,11
CPJQTBT 11/... (outside)	11	4,93	49,30	11,30
IPJQTBT 11/... (inside)	11	4,93	49,30	11,30
CPJQTBC/BO 125/... (outside)	12,5	2,77	27,70	6,11
IPJQTBC/BO 125/... (inside)	12,5	2,77	27,70	6,11
CPJQTBT 125/... (outside)	12,5	4,93	49,30	11,30
IPJQTBT 125/... (inside)	12,5	4,93	49,30	11,30
CPJQTAA 15/... (outside)	15	3,29	32,90	7,24
IPJQTAA 15/... (inside)	15	3,54	35,40	7,24
TPJQT... 06-08-10-11-125-15/...		2,26	22,60	4,93

JOINTS - PLASTIC

Article	H mm	€/Pc	€/pack. 10 pcs	€/pack. 2 pcs
GIJQT 06/...	6	2,16	21,60	4,72
GIJQT 08/...	8	2,16	21,60	4,72
GIJQT 10/...	10	2,16	21,60	4,72
GIJQT 11/...	11	2,16	21,60	4,72
GIJQT 125/...	12,5	2,16	21,60	4,72
GIJQT 15/...	15	2,16	21,60	4,72

Choose the desired packaging: E.g. GIJQT .../10 (pack 10 pcs)
GIJQT .../2 (pack 2 pcs)

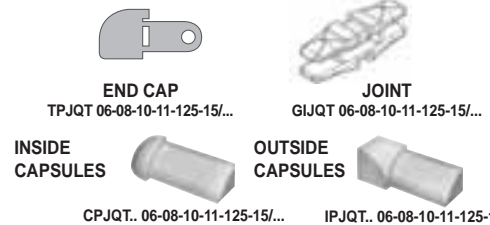

Choose the desired packaging. E.g.: CPJQTAA .../10 (Pack 10 pcs)
CPJQTAA .../2 (Pack 2 pcs)

Choose the desired packaging. E.g.: CPJQTBC .../10 (Pack 10 pcs)
CPJQTBC .../2 (Pack 2 pcs)

Prices are referred to whole packs. 10% increase for minimum orders of 10 pcs. 20% increase for orders of less than 10 pcs.

© 2011 All rights reserved by Progress Profiles. Printed in Italy

PROJOLLY QUART

POLISHED BRUSHED ALUMINIUM
VARNISHED ALUMINIUM

PROJOLLY QUART polished brushed aluminium (silver) and varnished aluminium available in 6 colors. **PROJOLLY QUART** is a rounded profile conceived to protect the external corners of wall coverings and to cover perimeter joints. The special quarter-of-circle shape of this profile, together with the range of finishes available and completing elements, such as inside/outside capsules and end caps make it a requested product, that can be used with any kind of wall and floor covering. Remove immediately the remains of glue or sealant from the profile surface, once the profile has been laid, otherwise these substances could lead to the formation of aluminium hydroxide, causing dark indelible stains on the profile surface.

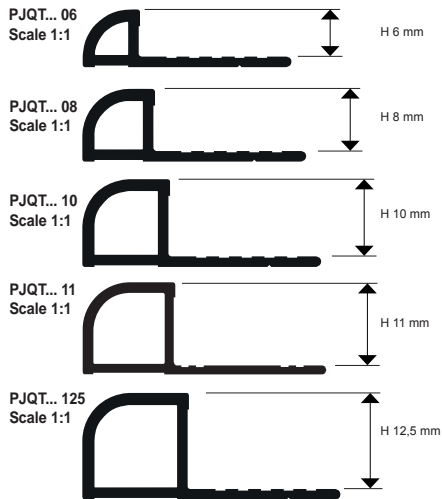

POLISHED BRUSHED ALUMINIUM (silver) thermo packed
bar length 2,7 LM - Pack. 40 Pcs - 108 LM

Article	H mm	€/LM	€/Pc
PJQTBS 08	8	8,11	21,90
PJQTBS 10	10	8,83	23,84
PJQTBS 11	11	9,30	25,11
PJQTBS 125	12,5	9,86	26,62



VARNISHED ALUMINIUM thermo packed
bar length 2,7 LM - Pack. 20 Pcs-54 LM (White colour 108 LM)

Article	H mm	€/LM	€/Pc
PJQTA 06-01 (white varn.)	6	4,62	12,47
PJQTA 08-...	8	5,15	13,91
PJQTA 10-...	10	5,55	14,99
PJQTA 11-01 (white varn.)	11	5,76	15,55
PJQTA 125-01 (white varn.)	12,5	5,96	16,09

EXAMPLES AND INSTRUCTIONS FOR LAYING METHODS

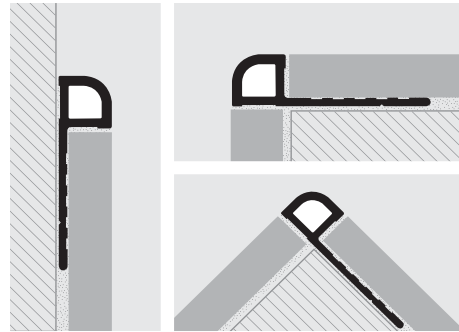

1. Choose PROJOLLY QUART in the desired finish and in the required height, according to the thickness of the tile; 2. Cut PROJOLLY QUART to the desired length and apply the adhesive on the area where the profile will be installed; 3. Press the anchoring flange of PROJOLLY QUART into the adhesive; 4. Lay the tiles and align them, so that the top edge of the profile is flush with the tile, leaving a 2mm joint. Remove immediately the remains of adhesive from the profile surface; 5. Fill the joints between the profile and the tiles with sealant, in order to avoid water stagnation. Remove immediately the remains of sealant from the profile surface.

UPON REQUEST MAY BE REALISED IN OTHER FINISHES OF THE COLOUR CHART. CONTACT OUR CUSTOMER SERVICE FOR MINIMUM QUANTITY, TIMING AND PRICE.

COLOURS



BS - Polish, brush, silver alu.

(for a precise assessment of colours and finishes, see the relative enclosed sheet)

COLOURS

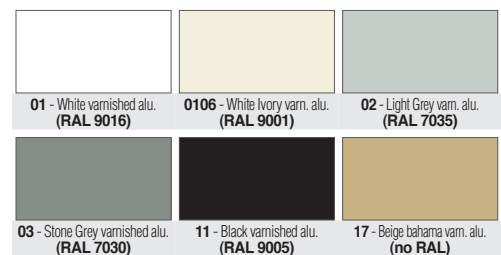

(for a precise assessment of colours and finishes, see the relative enclosed sheet)

PJQTA 06-..., PJQTA 11-... & PJQTA 125-... FOR OTHER COLOURS, DIFFERENT FROM WHITE, PLEASE CONTACT OUR CUSTOMER SERVICE FOR QUANTITY AND PRICE

© 2011 All rights reserved by Progress Profiles. Printed in Italy

CAPSULES, END CAPS & JOINTS for tri-axial joints

POLISHED BRUSHED, VARNISHED ALUMINIUM/ PLASTIC

JOINTS - PLASTIC

Article	H mm	€/Pc	€/pack. 10 pcs	€/pack. 2 pcs
GIJQT 06/...	6	2,16	21,60	4,72
GIJQT 08/...	8	2,16	21,60	4,72
GIJQT 10/...	10	2,16	21,60	4,72
GIJQT 11/...	11	2,16	21,60	4,72
GIJQT 125/...	12,5	2,16	21,60	4,72

Choose the desired packaging: E.g. GIJQT .../10 (pack 10 pcs)
GIJQT .../2 (pack 2 pcs)

LEFT CAPSULES & CAPS - POLISHED BRUSHED ALUMINIUM

Article	H mm	€/Pc	€/10 Pcs	€/2 Pcs
CPJQTBS 08/... (outside)	8	5,55	55,50	11,81
IPJQTBS 08/... (inside)	8	5,55	55,50	11,81
CPJQTBS 10/... (outside)	10	5,55	55,50	11,81
IPJQTBS 10/... (inside)	10	5,55	55,50	11,81
CPJQTBS 11/... (outside)	11	5,55	55,50	11,81
IPJQTBS 11/... (inside)	11	5,55	55,50	11,81
CPJQTBS 125/... (outside)	12,5	5,55	55,50	11,81
IPJQTBS 125/... (inside)	12,5	5,55	55,50	11,81
TPJQTBS 08-10-11-125/...		2,26	22,60	4,93

Choose the desired packaging. E.g.: CPJQTBS .../10 (Pack 10 pcs)
CPJQTBS .../2 (Pack 2 pcs)

LEFT CAPSULES & END CAPS - VARNISHED ALUMINIUM

Article	H mm	€/Pc	€/10 Pcs	€/2 Pcs
CPJQTA 06-01/... (outside)	6	2,88	28,80	6,16
IPJQTA 06-01/... (inside)	6	2,88	28,80	6,16
CPJQTA 08-.../... (outside)	8	2,88	28,80	6,16
IPJQTA 08-.../... (inside)	8	2,88	28,80	6,16
CPJQTA 10-.../... (outside)	10	2,88	28,80	6,16
IPJQTA 10-.../... (inside)	10	2,88	28,80	6,16
CPJQTA 11-.../... (outside)	11	2,88	28,80	6,16
IPJQTA 11-.../... (inside)	11	2,88	28,80	6,16
CPJQTA 125-01/... (outside)	12,5	2,88	28,80	6,16
IPJQTA 125-01/... (inside)	12,5	2,88	28,80	6,16
TPJQTA 06-08-10-11-125-.../...		2,26	22,60	4,93

Choose the desired packaging. E.g.: CPJQTA .../10 (Pack 10 pcs)
CPJQTA .../2 (Pack 2 pcs)



News 2015 available from January

OUTSIDE CAPSULES



INSIDE CAPSULES



The **PROJOLLY**, available IN 18 COLOURS, with EAN BAR CODE, facilitates installation, eliminating the fragile ceramic trim. It is used for outside corners of tiles to complete the finish of wall coverings, decking, steps, bathtubs, etc. Impeccable, precise work is ensured with a superior aesthetic effect. It strengthens the tile edge, thereby preventing chipping and breakages. It is made in certificated impact-resistant non-toxic PVC. Required by European standards for safety and hygiene in public and private environments. End caps and three-way inside and outside corner linking elements are available.

PROJOLLY QUART

NON-TOXIC, IMPACT RESISTANT
COLOURED VINYL RESIN

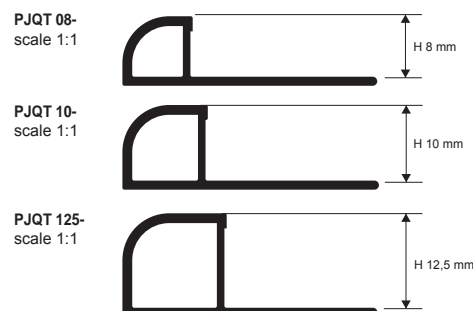

NON-TOXIC IMPACT-RESISTANT VINYL RESIN

bar length 2,7 LM - Pack. 54 LM (white colour Pack. 108 LM)

Article	H mm	€/LM	€/Pc
PJQT 08-...	8	1,06	2,86
PJQT 10-...	10	1,15	3,11
PJQT 125-...	12,5	1,25	3,38

Available in the colours: 01-02-03-04-05-06-07-08-09-10-11-12-13-14-15-16-17-18-0106 (19-20-21-22-23-24-25-26-27-28-29 available upon request with a minimum quantity order of 5400 LM). The code of the selected colour must be added to the article code. E.g.: PJQT 08... (chosen colour White) PJQT 08-01.

WHITE NOT FOR SALE SINGLY

EXAMPLES AND INSTRUCTIONS FOR LAYING METHODS

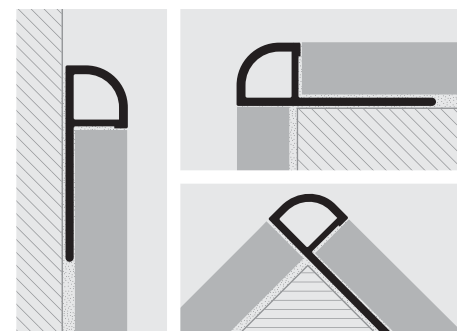

1. Choose the PROJOLLY QUART with suitable height for the thickness of the covering. 2. Apply the adhesive onto the area of application of the profile. 3. Lay and align the profile, cut to the necessary length, pressing the perforated flange into the adhesive. 4. Lay the tiles, aligning them so that the top edge of the profile is flush with the tile. 5. Fill the profile/tile area of contact with adhesive to prevent the accumulation of water in any voids.

COLOURS

(for a precise assessment of colours and finishes, see the relative enclosed sheet)

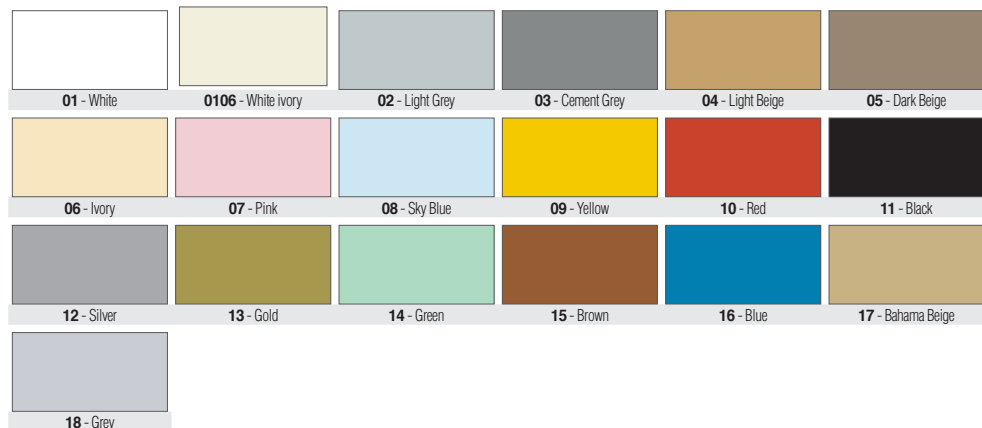

AVAILABLE minimum quantity 5400 LM by colour and height (price and delivery time to be agreed)



CAPSULES for tri-axial joints

POLYPROPYLENE/POLYETYLENE UV RESISTANT

POLYPROPYLENE/POLYETYLENE UV RESISTANT

Article	H mm	€/Pce	€/cond. 20 pcs	€/cond. 5 pcs
CPJQT 08-.../... (outside)	8	0,86	17,20	5,03
IPJQT 08-.../... (inside)	8	0,86	17,20	5,03
CPJQT 10-.../... (outside)	10	0,88	17,60	5,03
IPJQT 10-.../... (inside)	10	0,88	17,60	5,03
CPJQT 125-.../... (outside)	12,5	0,91	18,20	5,03
IPJQT 125-.../... (inside)	12,5	0,91	18,20	5,03

OUTSIDE CAPSULES

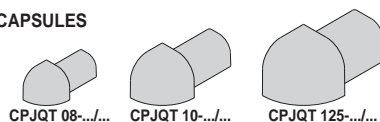

INSIDE CAPSULES

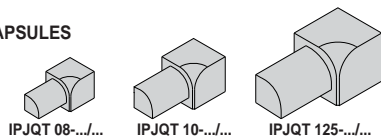

Available in the colours: 01-02-03-04-05-06-07-08-09-10-11-12-13-14-15-16-17-18-0106 (19-20-21-22-23-24-25-26-27-28-29 available upon request).

The code of the selected colour must be added to the article code. E.g.: CPJQT 08-.../... (chosen colour White) CPJQT 08-01/20.



PROJOLLY facilitates installation, eliminating the fragile ceramic trim. It is used for outside corners of tiles to complete the finish of wall coverings, decking, steps, bathtubs, etc. Impeccable, precise work is ensured with a superior aesthetic effect. It strengthens the tile edge, thereby preventing chipping and breakages. Required by European standards for safety and hygiene in public and private environments. Available **PROJOLLY MIRROR LINE** Hand polished to create a SUPER SHINY finish, to respond to modern/high tech needs and requirements with aesthetic and decorative finishes.

End caps and three-way inside and outside corner linking elements are available. Match with the **PROLISTEL** strips in stainless steel AISI 304/1.4301-V2A with polished or satin finish.

PROJOLLY

POLISHED, SUPER POLISHED AND SATINED STAINLESS STEEL AISI 304/1.4301-V2A



POLISHED STAINLESS STEEL AISI 304/1.4301-V2A with protective film - bar length 2,7 LM - packaging 40 Pcs - 108 LM (H 10 - 11 mm - 81 LM - H 12,5 - H 15 mm - 54 LM) - 10/10 mm

Article	H mm	€/LM	€/Pc
PJAC 06	6	9,24	24,95
PJAC 08	8	9,86	26,62
PJAC 10	10	10,63	28,70
PJAC 11	11	11,08	29,92
PJAC 125	12,5	11,40	30,78
PJAC 15	15	12,73	34,37



SATINED STAINLESS STEEL AISI 304/1.4301-V2A with protective film - bar length 2,7 LM - packaging 40 Pcs - 108 LM (H 10 - 11 mm - 81 LM - H 12,5 - H 15 mm - 54 LM) - 10/10 mm

Article	H mm	€/LM	€/Pc
PJACS 06	6	11,09	29,94
PJACS 08	8	11,71	31,62
PJACS 10	10	12,53	33,83
PJACS 11	11	12,95	34,97
PJACS 125	12,5	13,25	35,78
PJACS 15	15	14,58	39,37

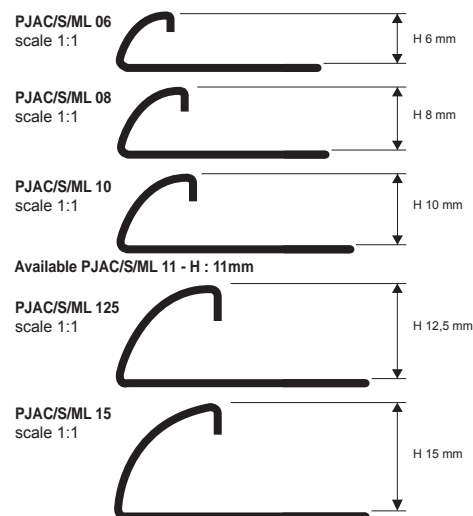

EXAMPLES AND INSTRUCTIONS FOR LAYING METHODS

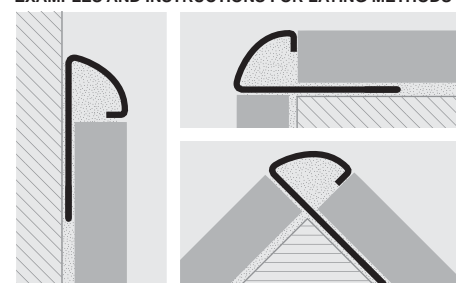

1. Choose a PROJOLLY height corresponding to the thickness of the covering/floor.
2. Apply the adhesive in the area that the square is being applied.
3. Rest and line up the square, cut to the required length, pressing the perforated tab into the adhesive.
4. Place the tiles lining them up so that the upper part of the square meets with their edge.
5. Fill the contact area between square and tile completely with adhesive to prevent the accumulation of water in the empty spaces.

SUPER POLISHED STAINLESS STEEL AISI 304/1.4301-V2A thermo packed bar length 2,7 LM - packaging 20 Pcs - 54 LM - 10/10 mm

Article	H mm	€/LM	€/Pc
PJACML 06	6	11,50	31,05
PJACML 08	8	12,12	32,72
PJACML 10	10	12,94	34,94
PJACML 11	11	13,30	35,91
PJACML 125	12,5	13,61	36,75
PJACML 15	15	14,89	40,20

COLOURS



AC - Polished stainless steel AISI 304/1.4301-V2A ACML - Super polished stainless steel AISI 304/1.4301-V2A ACS - Satined stainless steel AISI 304/1.4301-V2A

(for a precise assessment of colours and finishes, see the relative enclosed sheet)

SUITABLE FOR USE IN CONTACT WITH FOODSTUFFS

CAPSULES, END CAPS and JOINTS for tri-axial joints

POLISHED, SUPER POLISHED and SATINED STAINLESS STEEL AISI 304/1.4301-V2A / PLASTIC

CAPSULES & END CAPS - POLISHED STAINLESS STEEL AISI 304/1.4301-V2A

Article	H mm	€/Pc	€/pack. 10 pcs	€/pack. 2 pcs
CPJAC 06/... (outside)	6	11,27	112,70	24,65
IPJAC 06/... (inside)	6	11,27	112,70	24,65
CPJAC 08/... (outside)	8	11,81	118,10	25,68
IPJAC 08/... (inside)	8	11,81	118,10	25,68
CPJAC 10/... (outside)	10	12,68	126,80	26,70
IPJAC 10/... (inside)	10	12,68	126,80	26,70
CPJAC 11/... (outside)	11	13,25	132,50	27,73
IPJAC 11/... (inside)	11	13,25	132,50	27,73
CPJAC 125/... (outside)	12,5	13,76	137,60	28,76
IPJAC 125/... (inside)	12,5	13,76	137,60	28,76
CPJAC 15/... (outside)	15	14,89	148,90	31,32
IPJAC 15/... (inside)	15	14,89	148,90	31,32
TPJAC 06-08-10-125-15/... 6-8-10-12,5-15		2,26	22,60	4,93

Choose the desired packaging: E.g. CPJAC .../10 (pack 10 pcs) CPJAC .../2 (pack 2 pcs)

CAPSULES & END CAPS - SATINED STAINLESS STEEL AISI 304/1.4301-V2A

Article	H mm	€/Pc	€/pack. 10 pcs	€/pack. 2 pcs
CPJACS 06/... (outside)	6	12,43	124,30	25,68
IPJACS 06/... (inside)	6	12,43	124,30	25,68
CPJACS 08/... (outside)	8	12,84	128,40	26,70
IPJACS 08/... (inside)	8	12,84	128,40	26,70
CPJACS 10/... (outside)	10	13,66	136,60	28,24
IPJACS 10/... (inside)	10	13,66	136,60	28,24
CPJACS 11/... (outside)	11	14,15	141,50	29,53
IPJACS 11/... (inside)	11	14,15	141,50	29,53
CPJACS 125/... (outside)	12,5	14,58	145,80	30,81
IPJACS 125/... (inside)	12,5	14,58	145,80	30,81
CPJACS 15/... (outside)	15	15,91	159,10	33,38
IPJACS 15/... (inside)	15	15,91	159,10	33,38
TPJACS 06-08-10-125-15/... 6-8-10-12,5-15		2,26	22,60	4,93

Choose the desired packaging: E.g. CPJACS .../10 (pack 10 pcs) CPJACS .../2 (pack 2 pcs)

CAPSULES - SUPER POLISHED STAINLESS STEEL AISI 304/1.4301-V2A

Article	H mm	€/Pc	€/pack. 10 pcs	€/pack. 2 pcs
CPJACML 06/... (outside)	6	12,43	124,30	25,68
IPJACML 06/... (inside)	6	12,43	124,30	25,68
CPJACML 08/... (outside)	8	12,84	128,40	26,70
IPJACML 08/... (inside)	8	12,84	128,40	26,70
CPJACML 10/... (outside)	10	13,66	136,60	28,24
IPJACML 10/... (inside)	10	13,66	136,60	28,24
CPJACML 11/... (outside)	11	14,15	141,50	29,53
IPJACML 11/... (inside)	11	14,15	141,50	29,53
CPJACML 125/... (outside)	12,5	14,58	145,80	30,81
IPJACML 125/... (inside)	12,5	14,58	145,80	30,81
CPJACML 15/... (outside)	15	15,91	159,10	33,38
IPJACML 15/... (inside)	15	15,91	159,10	33,38

Choose the desired packaging: E.g. CPJACML .../10 (pack 10 pcs) CPJACML .../2 (pack 2 pcs)

JOINTS - PLASTIC

Article	H mm	€/Pc	€/pack. 10 pcs	€/pack. 2 pcs
GIJAC 06/...	6	2,16	21,60	4,72
GIJAC 08/...	8	2,16	21,60	4,72
GIJAC 10/...	10	2,16	21,60	4,72
GIJAC 11/...	11	2,16	21,60	4,72
GIJAC 125/...	12,5	2,16	21,60	4,72
GIJAC 15/...	15	2,16	21,60	4,72

Choose the desired packaging: E.g. GIJACAC .../10 (pack 10 pcs) GIJACAC .../2 (pack 2 pcs)

END CAP
TPJAC/S 06-08-10-11-125-15/...

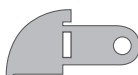

JOINT
GIJAC 06-08-10-11-125-15/...



OUTSIDE CAPSULES



CPJAC.. 06-08-10-11-125-15/...

INSIDE CAPSULES



IPJAC.. 06-08-10-11-125-15/...



PROJOLLY

POLISHED STAINLESS STEEL
AISI 316L/1.4404-V4A

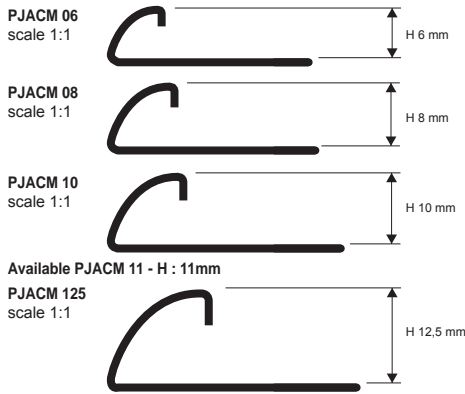

EXEMPLES OF LAYING

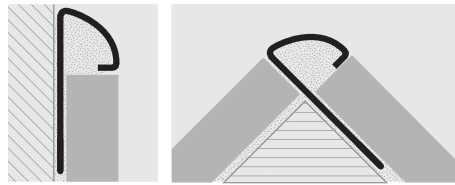

PROJOLLY are manufactured with the same forms and sections, as well as in the very resistant material, the stainless shiny steel 316L/1.4401-V4A, suitable for outdoors and marine environment with much presence of saltiness and considerable atmospheric agents. They are used as protection for the external angles of tiles, in order to separate or to create the separating joints in the pavements, to terminate the finishing of wall coverings, for platforms, stair steps, bathtubs, etc. They guarantee the impeccable work, ensuring considerable aesthetic effect as well. They strengthen the tile edge and prevents from chipping and breakages. Required by new European regulations on safety and accident prevention in public and private places. Available in capsules and three-axial joints for internal and external angles in stainless aisi 304/1.4301-V2A steel.



POLISHED STAINLESS STEEL AISI 316L/1.4404-V4A with protective film - bar length 2,7 LM - packaging 40 Pcs - 108 LM (H 10 - 11 mm - 81 LM - H 12,5 mm - 54 LM) - 10/10 mm

Article	H mm	€/LM	€/Pc
PJACM 06	6	11,61	31,35
PJACM 08	8	12,48	33,70
PJACM 10	10	13,40	36,18
PJACM 11	11	13,95	37,67
PJACM 125	12,5	14,28	38,56

COLOURS



(for a precise assessment of colours and finishes, see the relative enclosed sheet)

SUITABLE FOR USE IN CONTACT WITH FOODSTUFFS

CAPSULES for tri-axial joints

POLISHED STAINLESS STEEL AISI 316L/1.4404-V4A

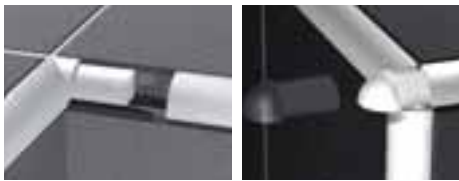

POLISHED STAINLESS STEEL AISI 316L/1.4404-V4A

Article	H mm	€/Pc	€/pack. 10 pcs	€/pack. 2 pcs
CPJACM 06/... (outside)	6	13,45	134,50	28,24
IPJACM 06/... (inside)	6	13,45	134,50	28,24
CPJACM 08/... (outside)	8	13,97	139,70	29,27
IPJACM 08/... (inside)	8	13,97	139,70	29,27
CPJACM 10/... (outside)	10	14,58	145,80	30,81
IPJACM 10/... (inside)	10	14,58	145,80	30,81
CPJACM 11/... (outside)	11	15,10	151,00	31,84
IPJACM 11/... (inside)	11	15,10	151,00	31,84
CPJACM 125/... (outside)	12,5	15,61	156,10	32,86
IPJACM 125/... (inside)	12,5	15,61	156,10	32,86

Choose the desired packaging: E.g. CPJACM .../10 (pack 10 pcs)
CPJACM .../2 (pack 2 pcs)

OUTSIDE CAPSULES



INSIDE CAPSULES

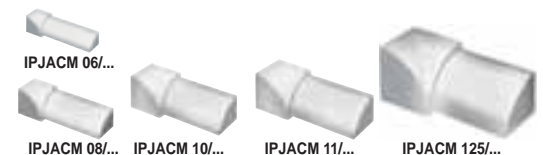

PROTERMINAL

POLISHED STAINLESS STEEL
AISI 316L/1.4404-V4A

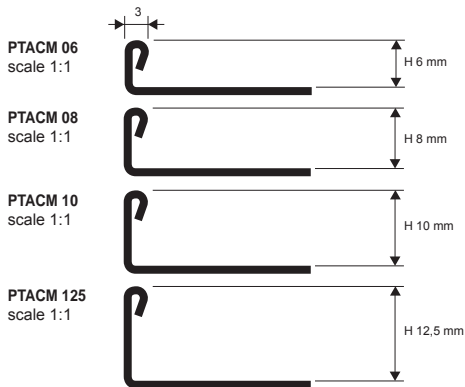

EXEMPLES OF LAYING

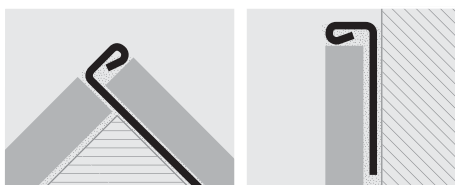

PROTERMINAL are manufactured with the same forms and sections, as well as in the very resistant material, the stainless shiny steel 316/1.4401-V4A, suitable for outdoors and marine environment with much presence of saltiness and considerable atmospheric agents. They are used as protection for the external angles of tiles, in order to separate or to create the separating joints in the pavements, to terminate the finishing of wall coverings, for platforms, stair steps, bathtubs, etc. They guarantee the impeccable work, ensuring considerable aesthetic effect as well. They strengthen the tile edge and prevents from chipping and breakages. Required by new European regulations on safety and accident prevention in public and private places.



POLISHED STAINLESS STEEL AISI 316L/1.4404-V4A
bar length 2,7 LM - packaging 40 Pcs - 108 LM - 10/10 mm

Article	H mm	€/LM	€/Pc
PTACM 06	6	8,83	23,84
PTACM 08	8	9,04	24,41
PTACM 10	10	9,50	25,65
PTACM 125	12,5	10,48	28,30

COLOURS



(for a precise assessment of colours and finishes, see the relative enclosed sheet)

SUITABLE FOR USE IN CONTACT WITH FOODSTUFFS

PROJOLLY in polished painted and chromed brass, it has been produced to give a very shiny finish with a high superficial resistance. **PROJOLLY** facilitates installation, eliminating the fragile ceramic trim. It is used for outside corners of tiles to complete the finish of wall coverings, decking, steps, bathtubs, etc. Impeccable, precise work is ensured with a superior aesthetic effect. It strengthens the tile edge, thereby preventing chipping and breakages. Required by European standards for safety and hygiene in public and private environments. End caps and three-way inside and outside corner linking elements are available. Matching with **PROLISTEL** strips in AISI 304/1.4301-V2A polished, Chromed polished aluminium and Chromed Brass is recommended.

PROJOLLY

NATURAL, POLISHED VARNISHED AND CHROMED BRASS (SUPER POLISHED - MIRROR LINE)

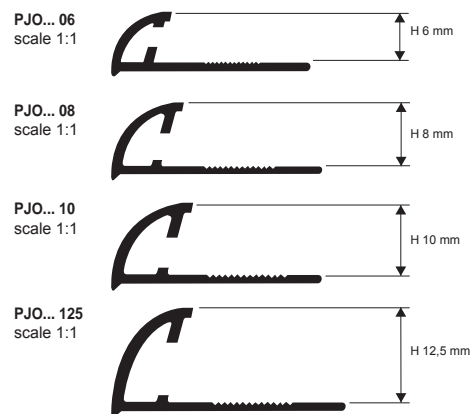

NATURAL BRASS
bar length 2,7 LM - Pack. 20 Pcs - 54 LM

Article	H mm	€/LM	€/Pc
PJON 08	8	12,07	32,59
PJON 10	10	12,79	34,53
PJON 125	12,5	14,22	38,39

VARNISHED POLISHED BRASS thermo packed
bar length 2,7 LM - Pack. 20 Pcs - 54 LM

Article	H mm	€/LM	€/Pc
PJOL 06	6	15,14	40,88
PJOL 08	8	15,76	42,55
PJOL 10	10	17,36	46,87
PJOL 125	12,5	19,79	53,43

Varnished polished brass is not suitable for frequent pedestrian traffic places and/or scratching.

CHROMED BRASS (SUPER POLISHED) thermo packed
bar length 2,7 LM - Pack. 20 Pcs - 54 LM

Article	H mm	€/LM	€/Pc
PJOC 06	6	16,59	44,79
PJOC 08	8	18,66	50,38
PJOC 10	10	19,55	52,79
PJOC 125	12,5	20,52	55,40



COLOURS

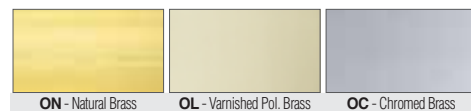

(for a precise assessment of colours and finishes, see the relative enclosed sheet)

EXAMPLES AND LAYING INSTRUCTIONS

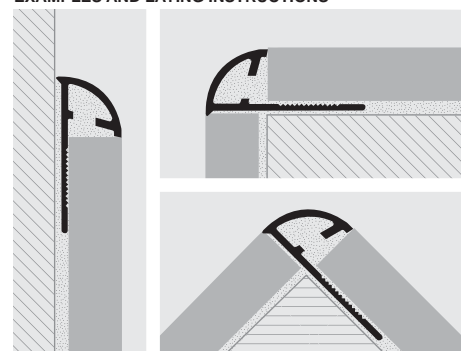

1. Choose the PROJOLLY with suitable height for the thickness of the covering.
 2. Apply the adhesive onto the area of application of the profile.
 3. Lay and align the profile, cut to the necessary length, pressing the perforated flange into the adhesive.
 4. Lay the tiles, aligning them so that the top edge of the profile is flush with the tile.
 5. Fill the profile/tile area of contact with adhesive to prevent the accumulation of water in any voids. Oxidation marks may be easily removed by polishing the profiles with specific products to be found on sale such as Sidol, Smac and similar.
- IMPORTANT:** Pay attention to the external edges of the polished painted and chromed brass Projolly. They must be protected against agents such as adhesives and sealants and against grinding or scraping actions.

© 2011 All rights reserved by Progress Profiles. Printed in Italy

CAPSULES, END CAPS and JOINTS for tri-axial joints

POLISHED VARNISHED BRASS and CHROMED BRASS EFFECT / PLASTIC

CAPS and JOINTS - CHROMED BRASS / PLASTIC

Article	H mm	€/Pc	€/pack. 10 pcs	€/pack. 2 pcs
TPJOC 06-08-10-125/...	6-8-10-12,5	2,26	22,60	4,93
GIJA 06-08-10-125/...	6-8-10-12,5	2,16	21,60	4,72

Choose the desired packaging: E.g. GIJA .../10 (pack 10 pcs)
GIJA .../2 (pack 2 pcs)

END CAP

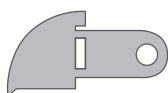

TPJOC 06-08-10-125/...



GIJA 06-08-10-125/...

OUTSIDE CAPSULES

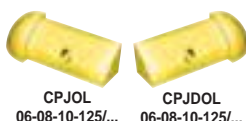

CPJOL 06-08-10-125/... CPJDOL 06-08-10-125/...
CPJOC 06-08-10-125/... CPJDOC 06-08-10-125/...

INSIDE CAPSULES

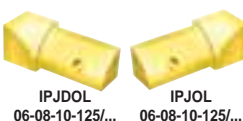

IPJDOL 06-08-10-125/... IPJOL 06-08-10-125/...
IPJDOC 06-08-10-125/... IPJOC 06-08-10-125/...

LEFT CAPSULES - POLISHED BRASS COATED

Article	H mm	€/Pc	€/pack. 10 pcs	€/pack. 2 pcs
CPJOL 06/... (outside)	6	14,79	147,90	32,86
IPJOL 06/... (inside)	6	16,95	169,50	36,97
CPJOL 08/... (outside)	8	15,05	150,50	33,38
IPJOL 08/... (inside)	8	17,20	172,00	37,49
CPJOL 10/... (outside)	10	15,30	153,00	33,89
IPJOL 10/... (inside)	10	17,41	174,10	38,00
CPJOL 125/... (outside)	12,5	15,66	156,60	34,92
IPJOL 125/... (inside)	12,5	17,77	177,70	38,51

Choose the desired packaging: E.g. CPJOL .../10 (pack 10 pcs)
CPJOL .../2 (pack 2 pcs)

LEFT CAPSULES - CHROMED BRASS

Article	H mm	€/Pc	€/pack. 10 pcs	€/pack. 2 pcs
CPJOC 06/... (outside)	6	14,79	147,90	32,86
IPJOC 06/... (inside)	6	16,95	169,50	36,97
CPJOC 08/... (outside)	8	15,05	150,50	33,38
IPJOC 08/... (inside)	8	17,20	172,00	37,49
CPJOC 10/... (outside)	10	15,30	153,00	33,89
IPJOC 10/... (inside)	10	17,41	174,10	38,00
CPJOC 125/... (outside)	12,5	15,66	156,60	34,92
IPJOC 125/... (inside)	12,5	17,77	177,70	38,51

Choose the desired packaging: E.g. CPJOC .../10 (pack 10 pcs)
CPJOC .../2 (pack 2 pcs)

The right capsules are available on demand and must be used only in the following cases:

A) when you are laying the cut base of the profile perpendicularly on the floor;

B) as an alternative to end-caps (right side).

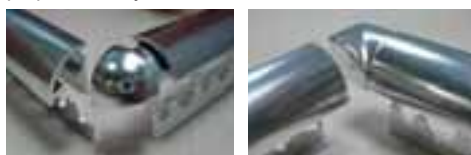

Add "D" to the article code. For example: CPJDOL 06.
Add "D" to the article code. For example: IPJDOL 06.

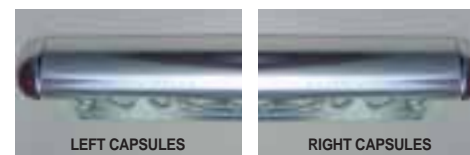

Add "D" to the article code. For example: CPJDOC 06.

PROJOLLY

ANODISED ALUMINIUM
BLACK-SILVER-COPPER-TITANIUM-GOLD

The **PROJOLLY** line in anodised aluminium offer innumerable opportunities of combining them with ceramics, wood, marble, etc. It facilitates the laying process eliminating the fragile ceramic corner tiles. It is also used for external angles of tiles, in order to terminate the finishing of wall coverings, for platforms, stair steps, bathtubs, etc. It guarantees the impeccable work, ensuring considerable aesthetic effect as well. Thanks to its round finishing it strengthens the tile edge and prevents from their chipping and breakages. Required by new European regulations on safety and accident prevention in public and private places. Available in capsules and three-axial joints for internal and external angles. Chromatic combining with **PROLISTEL** and **PROLISTEL** panelists in anodised aluminium recommended.

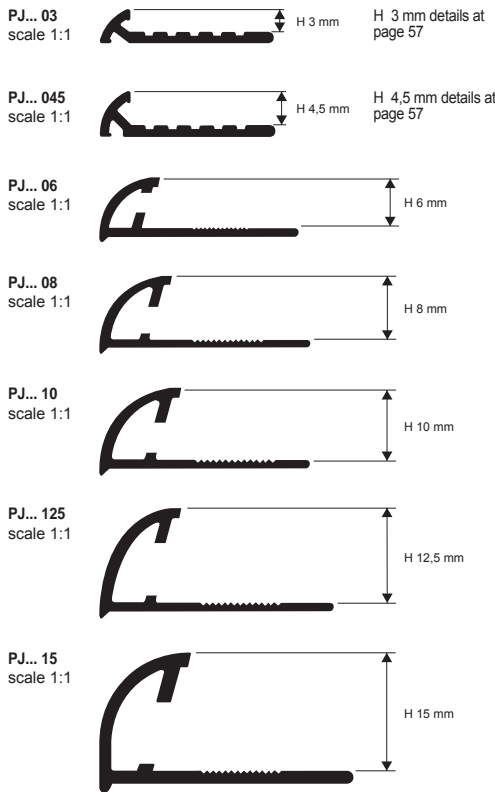

EXAMPLES AND INSTRUCTIONS FOR LAYING METHODS

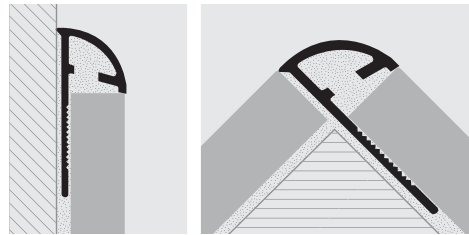

1. Choose the PROJOLLY with suitable height for the thickness of the covering. 2. Apply the adhesive onto the area of application of the profile. 3. Lay and align the profile, cut to the necessary length, pressing the perforated flange into the adhesive. 4. Lay the tiles, aligning them so that the top edge of the profile is flush with the tile. 5. Fill the profile/tile area of contact with adhesive to prevent the accumulation of water in any voids. **IMPORTANT:** Pay attention to the external edges of the aluminium Projolly. They must be protected against agents such as adhesives and sealants and against grinding or scraping actions.



ANODISED ALUMINIUM (silver-copper-titanium-gold- black)
thermo packed - bar length 2,7 LM - packaging 40 Pcs - 108 LM
(H 15 alu. anodised Pack. 20 Pcs - 54 LM)

Article	H mm	€/LM	€/Pc
PJAA 06 (anod. silver)	6	4,01	10,83
PJAO 06 (anod. gold)	6	4,01	10,83
PJAA 08 (anod. silver)	8	4,26	11,50
PJAR 08 (anod. copper)	8	4,71	12,72
PJAT 08 (anod. titanium)	8	4,71	12,72
PJAO 08 (anod. gold)	8	4,26	11,50
PJNE 08 (anod. black)	8	6,12	16,52
PJAA 10 (anod. silver)	10	4,60	12,42
PJAR 10 (anod. copper)	10	5,12	13,82
PJAT 10 (anod. titanium)	10	5,12	13,82
PJAO 10 (anod. gold)	10	4,60	12,42
PJNE 10 (anod. black)	10	6,66	17,98
PJAA 125 (anod. silver)	12,5	5,19	14,01
PJAR 125 (anod. copper)	12,5	5,76	15,55
PJAT 125 (anod. titanium)	12,5	5,76	15,55
PJNE 125 (anod. black)	12,5	7,49	20,22
PJAA 15 (anod. silver)	15	5,80	15,66

PJAO 15 available upon request, price and delivery time to be agreed.

COLOURS

(for a precise assessment of colours and finishes, see the relative enclosed sheet)



CAPSULES, END CAPS and JOINTS for tri-axial joints

ANODISED ALUMINIUM (silver, copper, titanium, gold and black) / PLASTIC

LEFT CAPSULES ANODISED silver, copper, titanium and gold ALUMINIUM

Article	H mm	€/Pc	€/pack. 10 pcs	€/pack. 2 pcs
CPJAA/AO 06/... (outside)	6	2,77	27,70	6,11
IPJAA/AO 06/... (inside)	6	2,77	27,70	6,11
CPJAA/AO 08/... (outside)	8	2,77	27,70	6,11
IPJAA/AO 08/... (inside)	8	2,77	27,70	6,11
CPJAR 08/... (outside)	8	4,93	49,30	11,30
IPJAR 08/... (inside)	8	4,93	49,30	11,30
CPJAT 08/... (outside)	8	4,93	49,30	11,30
IPJAT 08/... (inside)	8	4,93	49,30	11,30
CPJAA/AO 10/... (outside)	10	2,77	27,70	6,11
IPJAA/AO 10/... (inside)	10	2,77	27,70	6,11
CPJAR 10/... (outside)	10	4,93	49,30	11,30
IPJAR 10/... (inside)	10	4,93	49,30	11,30
CPJAT 10/... (outside)	10	4,93	49,30	11,30
IPJAT 10/... (inside)	10	4,93	49,30	11,30
CPJAA 125/... (outside)	12,5	2,77	27,70	6,11
IPJAA 125/... (inside)	12,5	2,77	27,70	6,11
CPJAR 125/... (outside)	12,5	4,93	49,30	11,30
IPJAR 125/... (inside)	12,5	4,93	49,30	11,30
CPJAT 125/... (outside)	12,5	4,93	49,30	11,30
IPJAT 125/... (inside)	12,5	4,93	49,30	11,30
CPJAA 15/... (outside)	15	3,29	32,90	7,24
IPJAA 15/... (inside)	15	3,54	35,40	7,24

Choose the desired packaging: E.g. CPJAA .../10 (pack 10 pcs)
CPJAA .../2 (pack 2 pcs)

LEFT CAPSULES ANODISED ALUMINIUM black

Article	H mm	€/Pc	€/pack. 10 pcs	€/pack. 2 pcs
CPJNE 08/...	8	6,41	64,10	14,10
IPJNE 08/...	8	6,41	64,10	14,10
CPJNE 10/...	10	6,41	64,10	14,10
IPJNE 10/...	10	6,41	64,10	14,10
CPJNE 125/...	12,5	6,41	64,10	14,10
IPJNE 125/...	12,5	6,41	64,10	14,10

Choose the desired packaging: E.g. CPJNE .../10 (pack 10 pcs)
CPJNE .../2 (pack 2 pcs)

CAPS - ANODISED ALUMINIUM silver, copper, titanium, gold,

Article	H mm	€/Pc	€/pack. 10 pcs	€/pack. 2 pcs
TPJ... 06-08-10-125-15/...	6-8-10-12,5-15	2,26	22,60	4,93

JOINTS - PLASTIC

Article	H mm	€/Pc	€/pack. 10 pcs	€/pack. 2 pcs
GJJA 06-08-10-125-15/...	6-8-10-12,5-15	2,16	21,60	4,72

OUTSIDE CAPSULES

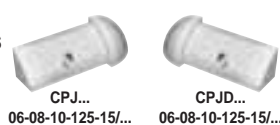

INSIDE CAPSULES

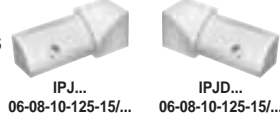

The right capsules are available on demand and must be used only in the following cases:

A) when you are laying the cut base of the profile perpendicularly on the floor;



Add "D" to the article code. For example: CPJDAA 06.

Add "D" to the article code. For example: IPJDAA 06.

B) as an alternative to end-caps (right side).

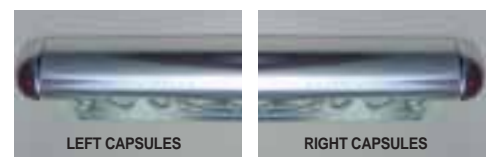

Add "D" to the article code. For example: CPJDAA 06.

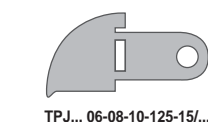

The **PROJOLLY** line in polished aluminium offer innumerable opportunities of combining them with ceramics, wood, marble, etc. It facilitates the laying process eliminating the fragile ceramic corner tiles. It is also used for external angles of tiles, in order to terminate the finishing of wall coverings, for platforms, stair steps, bathtubs, etc. It guarantees the impeccable work, ensuring considerable aesthetic effect as well. Thanks to its round finishing it strengthens the tile edge and prevents from their chipping and breakages. Required by new European regulations on safety and accident prevention in public and private places. Available in capsules and three-axial joints for internal and external angles. Chromatic combining with **PROLISTEL** and **PROLISTEL** panelists in polished aluminium recommended.

PROJOLLY

POLISHED ALUMINIUM
CHROME-COPPER-TITANIUM-GOLD-BLACK



POLISHED ALUMINIUM (chrome-copper-titanium-gold-black) thermo packed
bar length 2,7 LM - packaging 40 Pcs - 108 LM (H 15 mm - 54 LM)

Article	H mm	€/LM	€/Pc
PJBC 06 (polished chrome)	6	6,52	17,60
PJBO 06 (polished gold)	6	6,52	17,60
PJBR 08 (polished copper)	8	7,03	18,98
PJBT 08 (polished titanium)	8	7,03	18,98
PJBO 08 (polished gold)	8	7,03	18,98
PJBC 08 (polished chrome)	8	7,03	18,98
PJBN 08 (polished black)	8	9,14	24,68
PJBR 10 (polished copper)	10	7,81	21,09
PJBT 10 (polished titanium)	10	7,81	21,09
PJBO 10 (polished gold)	10	7,81	21,09
PJBC 10 (polished chrome)	10	7,81	21,09
PJBN 10 (polished black)	10	9,60	25,92
PJBR 125 (polished copper)	12,5	8,83	23,84
PJBT 125 (polished titanium)	12,5	8,83	23,84
PJBO 125 (polished gold)	12,5	8,83	23,84
PJBC 125 (polished chrome)	12,5	8,83	23,84
PJBN 125 (polished black)	12,5	10,25	27,68
PJBC 15 (polished chrome)	15	9,61	25,95

EXAMPLES AND INSTRUCTIONS FOR LAYING METHODS

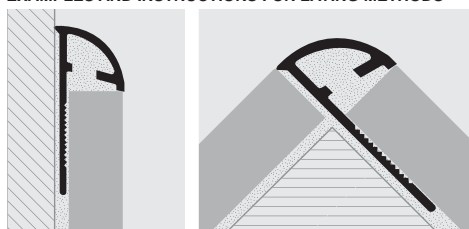

1. Choose the PROJOLLY with suitable height for the thickness of the covering. 2. Apply the adhesive onto the area of application of the profile. 3. Lay and align the profile, cut to the necessary length, pressing the perforated flange into the adhesive. 4. Lay the tiles, aligning them so that the top edge of the profile is flush with the tile. 5. Fill the profile/tile area of contact with adhesive to prevent the accumulation of water in any voids. **IMPORTANT:** Pay attention to the external edges of the aluminium Projolly. They must be protected against agents such as adhesives and sealants and against grinding or scraping actions.

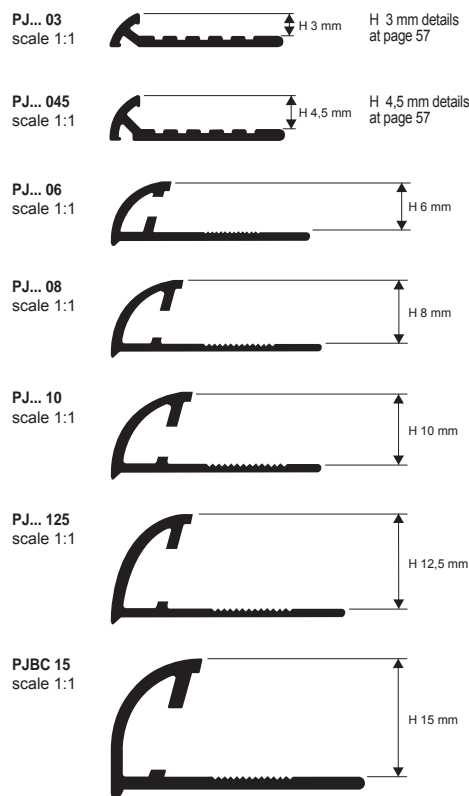

COLOURS

(for a precise assessment of colours and finishes, see the relative enclosed sheet)



CAPSULES, END CAPS and JOINTS for tri-axial joints

POLISHED ALUMINIUM (chrome, copper, titanium, gold, black) / PLASTIC

END CAPS - POLI. ALUMINIUM chrome, copper, titanium, gold, black

Article	H mm	€/Pc	€/pack. 10 pcs	€/pack. 2 pcs
TPJ... 06-08-10-125-15/...	6-8-10-12,5-15	2,26	22,60	4,93

JOINTS - PLASTIC

Article	H mm	€/Pc	€/pack. 10 pcs	€/pack. 2 pcs
GJJA 06-08-10-125-15/...	6-8-10-12,5-15	2,16	21,60	4,72

Choose the desired packaging: E.g. GJJA.../10 (pack 10 pcs)
GJJA.../2 (pack 2 pcs)

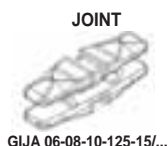
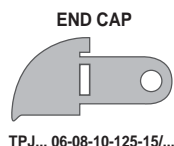

OUTSIDE CAPSULES



INSIDE CAPSULES



LEFT CAPSULES POLISHED ALUMINIUM chrome, copper, titanium and gold

Article	H mm	€/Pc	€/pack. 10 pcs	€/pack. 2 pcs
CPJBC/BO 06/... (outside)	6	2,77	27,70	6,11
IPJBC/BO 06/... (inside)	6	2,77	27,70	6,11
CPJBC/BO 08/... (outside)	8	2,77	27,70	6,11
IPJBC/BO 08/... (inside)	8	2,77	27,70	6,11
CPJBR 08/... (outside)	8	6,98	69,80	18,89
IPJBR 08/... (inside)	8	6,98	69,80	18,89
CPJBT 08/... (outside)	8	4,93	49,30	11,30
IPJBT 08/... (inside)	8	4,93	49,30	11,30
CPJBC/BO 10/... (outside)	10	2,77	27,70	6,11
IPJBC/BO 10/... (inside)	10	2,77	27,70	6,11
CPJBR 10/... (outside)	10	6,98	69,80	18,89
IPJBR 10/... (inside)	10	6,98	69,80	18,89
CPJBT 10/... (outside)	10	4,93	49,30	11,30
IPJBT 10/... (inside)	10	4,93	49,30	11,30
CPJBC/BO 125/... (outside)	12,5	2,77	27,70	6,11
IPJBC/BO 125/... (inside)	12,5	2,77	27,70	6,11
CPJBR 125/... (outside)	12,5	6,98	69,80	18,89
IPJBR 125/... (inside)	12,5	6,98	69,80	18,89
CPJBT 125/... (outside)	12,5	4,93	49,30	11,30
IPJBT 125/... (inside)	12,5	4,93	49,30	11,30
CPJBC 15/... (outside)	15	3,29	32,90	7,24
IPJBC 15/... (inside)	15	3,54	35,40	7,24

Choose the desired packaging: E.g. CPJBC.../10 (pack 10 pcs)
CPJBC.../2 (pack 2 pcs)

LEFT CAPSULES POLISHED ALUMINIUM black

Article	H mm	€/Pc	€/pack. 10 pcs	€/pack. 2 pcs
CPJBN 08/...	8	9,07	90,70	19,95
IPJBN 08/...	8	9,07	90,70	19,95
CPJBN 10/...	10	9,07	90,70	19,95
IPJBN 10/...	10	9,07	90,70	19,95
CPJBN 125/...	12,5	9,07	90,70	19,95
IPJBN 125/...	12,5	9,07	90,70	19,95

The right capsules are available on demand and must be used only in the following cases:

A) when you are laying the cut base of the profile perpendicularly on the floor;



Add "D" to the article code. For example: CPJDBC 06. Add "D" to the article code. For example: IPJDBC 06.

B) as an alternative to end-caps (right side).

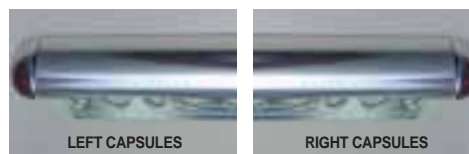

Add "D" to the article code. For example: CPJDBC 06.

PROJOLLY

POLISHED BRUSHED ALUMINIUM
BLACK-SILVER-COPPER-TITANIUM

PROJOLLY facilitates installation, eliminating the fragile ceramic trim. It is used for outside corners of tiles to complete the finish of wall coverings, decking, steps, bathtubs, etc. Impeccable, precise work is ensured with a superior aesthetic effect. It strengthens the tile edge, thereby preventing chipping and breakages. Required by European standards for safety and hygiene in public and private environments. End caps and three-way inside and outside corner linking elements are available. Match with the **PROLISTEL** strips in anodised or polished aluminium.

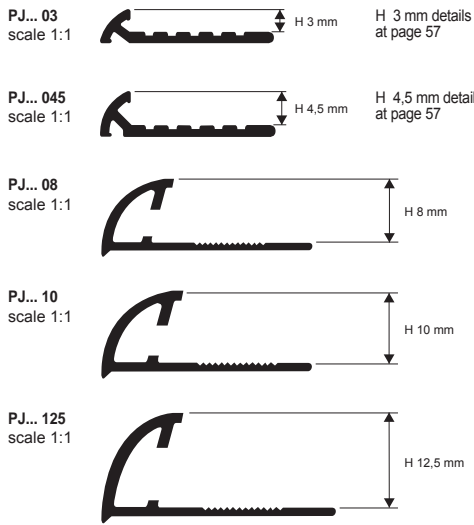

POLISHED BRUSHED ALUMINIUM (silver-copper-titanium-black) thermo packed - bar length 2,7 LM - packaging 40 Pcs - 108 LM

Article	H mm	€/LM	€/Pc
PJBS 08	8	8,11	21,90
PJRS 08	8	8,11	21,90
PJTS 08	8	8,11	21,90
PJNS 08	8	10,30	27,81
PJBS 10	10	8,83	23,84
PJRS 10	10	8,83	23,84
PJTS 10	10	8,83	23,84
PJNS 10	10	11,20	30,24
PJBS 125	12,5	9,86	26,62
PJRS 125	12,5	9,86	26,62
PJTS 125	12,5	9,86	26,62
PJNS 125	12,5	12,70	34,29

EXAMPLES AND INSTRUCTIONS FOR LAYING METHODS

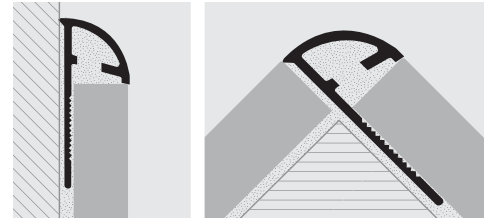

1. Choose the PROJOLLY with suitable height for the thickness of the covering. 2. Apply the adhesive onto the area of application of the profile. 3. Lay and align the profile, cut to the necessary length, pressing the perforated flange into the adhesive. 4. Lay the tiles, aligning them so that the top edge of the profile is flush with the tile. 5. Fill the profile/tile area of contact with adhesive to prevent the accumulation of water in any voids. **IMPORTANT:** Pay attention to the external edges of the aluminium Projolly. They must be protected against agents such as adhesives and sealants and against grinding or scraping actions.

COLOURS

(for a precise assessment of colours and finishes, see the relative enclosed sheet)

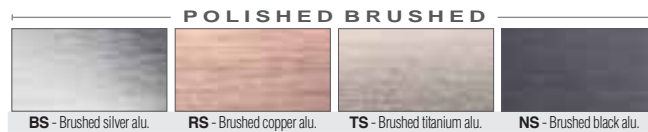

CAPSULES, END CAPS and JOINTS for tri-axial joints

POLISHED BRUSHED ALUMINIUM (silver-copper-titanium-black) / PLASTIC

LEFT CAPSULES BRUSHED ALUMINIUM (silver-copper-titanium-black)

Article	H mm	€/Pc	€/pack. 10 pcs	€/pack. 2 pcs
CPJBS 08/... (outside)	8	5,55	55,50	11,81
IPJBS 08/... (inside)	8	5,55	55,50	11,81
CPJRS 08/... (outside)	8	5,50	55,50	11,81
IPJRS 08/... (inside)	8	5,50	55,50	11,81
CPJTS 08/... (outside)	8	5,50	55,50	11,81
IPJTS 08/... (inside)	8	5,50	55,50	11,81
CPJNS 08/... (outside)	8	7,15	71,50	15,73
IPJNS 08/... (inside)	8	7,15	71,50	15,73
CPJBS 10/... (outside)	10	5,55	55,50	11,81
IPJBS 10/... (inside)	10	5,55	55,50	11,81
CPJRS 10/... (outside)	10	5,50	55,50	11,81
IPJRS 10/... (inside)	10	5,50	55,50	11,81
CPJTS 10/... (outside)	10	5,55	55,50	11,81
IPJTS 10/... (inside)	10	5,50	55,50	11,81
CPJNS 10/... (outside)	10	7,15	71,50	15,73
IPJNS 10/... (inside)	10	7,15	71,50	15,73
CPJBS 125/... (outside)	12,5	5,55	55,50	11,81
IPJBS 125/... (inside)	12,5	5,55	55,50	11,81
CPJRS 125/... (outside)	12,5	5,50	55,50	11,81
IPJRS 125/... (inside)	12,5	5,50	55,50	11,81
CPJTS 125/... (outside)	12,5	5,50	55,50	11,81
IPJTS 125/... (inside)	12,5	5,50	55,50	11,81
CPJNS 125/... (outside)	12,5	7,15	71,50	15,73
IPJNS 125/... (inside)	12,5	7,15	71,50	15,73

Choose the desired packaging: E.g. CPJBS .../10 (pack 10 pcs)
CPJBS .../2 (pack 2 pcs)

END CAPS - BRUSHED ALUMINIUM (silver-copper-titanium-black)

Article	H mm	€/Pc	€/pack. 10 pcs	€/pack. 2 pcs
TPJ... 08-10-125/...	8-10-12,5	2,26	22,60	4,93

JOINTS - PLASTIC

Article	H mm	€/Pc	€/pack. 10 pcs	€/pack. 2 pcs
GJJA 08-10-125/...	8-10-12,5	2,16	21,60	4,72

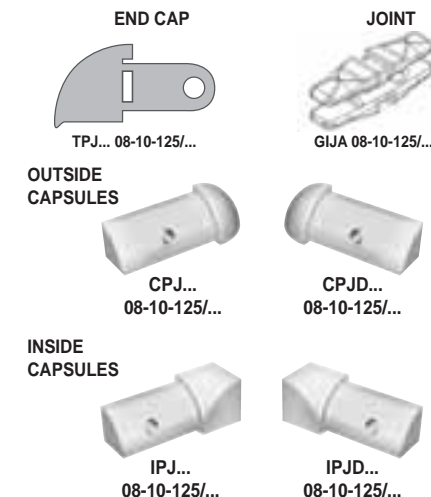

The right capsules are available on demand and must be used only in the following cases:

A) when you are laying the cut base of the profile perpendicularly on the floor;



Add "D" to the article code. For example: CPJDBS 08. Add "D" to the article code. For example: IPJDBS 08.

B) as an alternative to end-caps (right side).

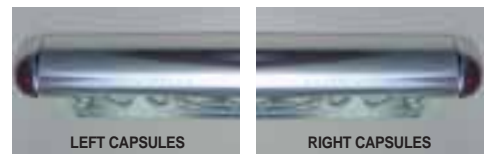

Add "D" to the article code. For example: CPJDBS 08.

*= Upon request, price and delivery time to be agreed.

Prices are referred to whole packs. 10% increase for minimum orders of 10 pcs. 20% increase for orders of less than 10 pcs.

PROJOLLY facilitates installation, eliminating the fragile ceramic trim. It is used for outside corners of tiles to complete the finish of wall coverings, decking, steps, bathtubs, etc. Impeccable, precise work is ensured with a superior aesthetic effect. It strengthens the tile edge, thereby preventing chipping and breakages. Required by European standards for safety and hygiene in public and private environments. End caps and three-way inside and outside corner linking elements are available.

PROJOLLY

VARNISHED ALUMINIUM

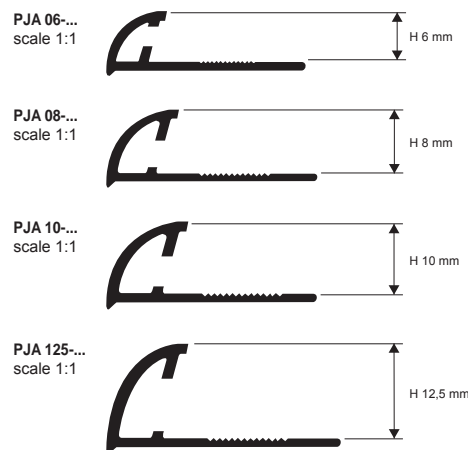

VARNISHED ALUMINIUM (HOT-WORKED 200°) thermo packed
bar length 2,7 LM - Pack. 20 Pcs-54 LM (White colour 108 LM)

Article	H mm	€/LM	€/Pc
PJA 06-01 (white)	6	4,62	12,47
PJA 08...	8	5,15	13,91
PJA 10...	10	5,55	14,99
PJA 125-01 (white)	12,5	5,96	16,09

With H 8 and 10 mm available in the colours: 01 - 0106 - 02 - 03 - 0211 - 0311 - 06 - 10 - 11 - 17.

The code of the selected colour must be added to the article code.
E.g.: PJA 08... (chosen colour White) PJA 08-01.

**UPON REQUEST MAY BE REALISED IN OTHER FINISHES OF THE COLOUR CHART.
CONTACT OUR CUSTOMER SERVICE FOR MINIMAL QUANTITY, TIMING AND PRICE.**

COLOURS

(for a precise assessment of colours and finishes, see the relative enclosed sheet)

01 - White varnished alu. (RAL 9016)	0106 - White Ivory varn. alu. (RAL 9001)	02 - Light Grey varnished alu. (RAL 7035)	03 - Stone Grey varnished alu. (RAL 7030)	0211 - Quartz Grey varn. alu. (RAL 7039)	0311 - Asphalt Grey varn. alu. (RAL 7043)
				PJA 06-... & PJA 125-... FOR COLOURS DIFFERENT FROM WHITE CONTACT THE COMPANY FOR QUANTITY AND PRICE	
06 - Ivory varnished alu. (RAL 1015)	10 - Klinker Red varnished alu. (RAL 8004)	11 - Black varnished alu. (RAL 9005)	17 - Beige bahama varnished alu. (no RAL)		

EXAMPLES AND INSTRUCTIONS FOR LAYING METHODS

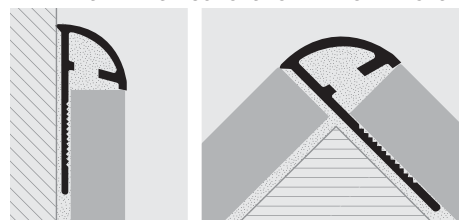

1. Choose the PROJOLLY with suitable height for the thickness of the covering.
 2. Apply the adhesive onto the area of application of the profile.
 3. Lay and align the profile, cut to the necessary length, pressing the perforated flange into the adhesive.
 4. Lay the tiles, aligning them so that the top edge of the profile is flush with the tile.
 5. Fill the profile/tile area of contact with adhesive to prevent the accumulation of water in any voids.
- IMPORTANT:** Pay attention to the external edges of the aluminium Projolly. They must be protected against agents such as adhesives and sealants and against grinding or scraping actions.

CAPSULES, END CAPS and JOINTS for tri-axial joints

VARNISHED ALUMINIUM / PLASTIC

LEFT CAPSULES VARNISHED ALUMINIUM (HOT-WORKED 200°)

Article	H mm	€/Pc	€/pack. 10 pcs	€/pack. 2 pcs
CPJA 06-01/... (outside)	6	2,88	28,80	6,16
IPJA 06-01/... (inside)	6	2,88	28,80	6,16
CPJA 08-.../... (outside)	8	2,88	28,80	6,16
IPJA 08-.../... (inside)	8	2,88	28,80	6,16
CPJA 10-.../... (outside)	10	2,88	28,80	6,16
IPJA 10-.../... (inside)	10	2,88	28,80	6,16
CPJA 125-01/... (outside)	12,5	2,88	28,80	6,16
IPJA 125-01/... (inside)	12,5	2,88	28,80	6,16

With H 8 and 10 mm available in the colours: 01 - 0106 - 02 - 03 - 0211 - 0311 - 06 - 10 - 11 - 17.

The code of the selected colour must be added to the article code.
E.g.: CPJA 08-.../... (chosen colour White) CPJA 08-01/10.

END CAPS - VARNISHED ALUMINIUM (HOT-WORKED 200°)

Article	H mm	€/Pc	€/pack. 10 pcs	€/pack. 2 pcs
TPJA... 06/...	6	2,26	22,60	4,93
TPJA... 08/...	8	2,26	22,60	4,93
TPJA... 10/...	10	2,26	22,60	4,93
TPJA... 125/...	12,5	2,26	22,60	4,93

JOINTS - PLASTIC

Article	H mm	€/Pc	€/pack. 10 pcs	€/pack. 2 pcs
GIJA 06/...	6	2,16	21,60	4,72
GIJA 08/...	8	2,16	21,60	4,72
GIJA 10/...	10	2,16	21,60	4,72
GIJA 125/...	12,5	2,16	21,60	4,72

Choose the desired packaging: E.g. GIJA .../10 (pack 10 pcs)
GIJA .../2 (pack 2 pcs)

The right capsules are available on demand and must be used only in the following cases:

A) when you are laying the cut base of the profile perpendicularly on the floor;



Add "D" to the article code. For example: CPJDA 06-01. Add "D" to the article code. For example: IPJDA 06-01.

B) as an alternative to end-caps (right side).



Add "D" to the article code. For example: CPJDA 06-01.

OUTSIDE CAPSULES

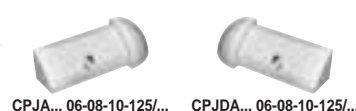

CPJA... 06-08-10-125/... CPJDA... 06-08-10-125/...

INSIDE CAPSULES



IPJA... 06-08-10-125/... IPJDA... 06-08-10-125/...

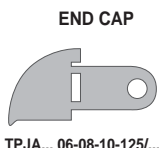

PROJOLLY

IMPACT-RESISTANT NON-TOXIC
COLOURED VINYL RESIN

The **PROJOLLY**, available in 18 COLOURS, with EAN BAR CODE, facilitates installation, eliminating the fragile ceramic trim. It is used for outside corners of tiles to complete the finish of wall coverings, decking, steps, bathtubs, etc. Impeccable, precise work is ensured with a superior aesthetic effect. It strengthens the tile edge, thereby preventing chipping and breakages. It is made in certificated impact-resistant non-toxic PVC. Required by European standards for safety and hygiene in public and private environments. End caps and three-way inside and outside corner linking elements are available.

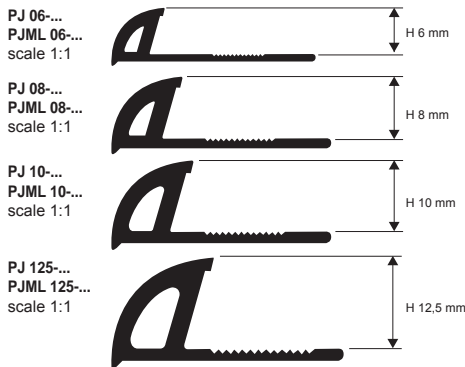

EXAMPLES AND INSTRUCTIONS FOR LAYING METHODS

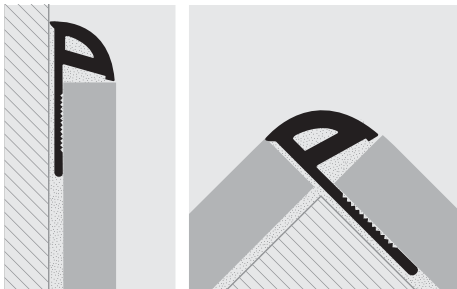

1. Choose the PROJOLLY with suitable height for the thickness of the covering.
2. Apply the adhesive onto the area of application of the profile.
3. Lay and align the profile, cut to the necessary length, pressing the perforated flange into the adhesive.
4. Lay the tiles, aligning them so that the top edge of the profile is "flush" with the tile.
5. Fill the profile/tile area of contact with adhesive to prevent the accumulation of water in any voids.

NON-TOXIC IMPACT-RESISTANT VINYL RESIN

bar length **2,7 LM** - Pack. **54 LM** (colour white Pack. **108 LM**)

Article	H mm	€/LM	€/Pc
PJ 06-...	6	0,94	2,54
PJ 08-...	8	1,06	2,86
PJ 10-...	10	1,15	3,11
PJ 125-...	12,5	1,25	3,38

Available in the colours: 01-02-03-04-05-06-07-08-09-10-11-12-13-14-15-16-17-18-0106 (19-20-21-22-23-24-25-26-27-28-29 available upon request with a minimum quantity order of 5400 LM). The code of the selected colour must be added to the article code. E.g.: PJ-...06 (chosen colour White) PJ 06-01.

WHITE NOT FOR SALE SINGLY

NON-TOXIC IMPACT-RESISTANT VINYL RESIN

Mirror Line extra polished

bar length **2,7 LM** - Pack. **54 LM** (colour white Pack. **108 LM**)

Article	H mm	€/LM	€/Pc
PJML 06-...	6	1,17	3,16
PJML 08-...	8	1,27	3,43
PJML 10-...	10	1,38	3,73

FINISHING NR 12 AND 13 EXCLUDED

Available in the colours: 01-02-03-04-05-06-07-08-09-10-11-14-15-16-17-18-0106 (19-20-21-22-23-24-25-26-27-28-29 available upon request with a minimum quantity order of 5400 LM). The code of the selected colour must be added to the article code. E.g.: PJ 06-... (chosen colour White) PJ 06-01. Prices per metre are approximate. Articles not for sale singly.

WHITE NOT FOR SALE SINGLY

COLOURS

(for a precise assessment of colours and finishes, see the relative enclosed sheet)

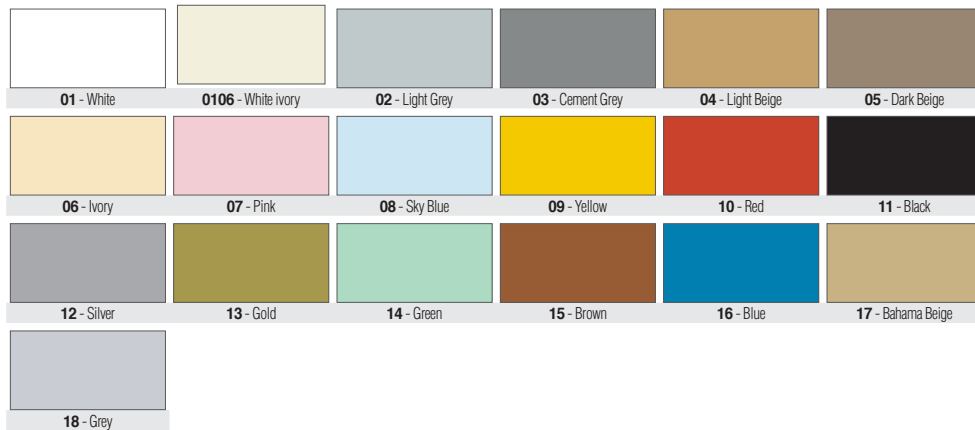

AVAILABLE minimum quantity **5400 LM** by colour and height (price and delivery time to be agreed)

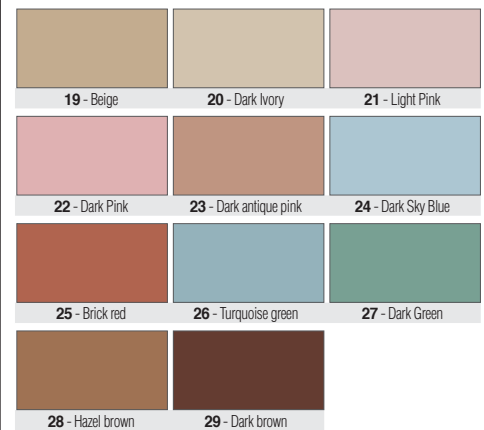

CAPSULES for tri-axial joints

POLYPROPYLENE/POLYETYLENE UV RESISTANT

POLYPROPYLENE/POLYETYLENE UV RESISTANT

Article	H mm	€/Pc	€/pack. 20 pcs	€/pack. 5 pcs
CPJ 06-.../... (outside)	6	0,84	16,80	5,03
IPJ 06-.../... (inside)	6	0,84	16,80	5,03
CPJ 08-.../... (outside)	8	0,86	17,20	5,03
IPJ 08-.../... (inside)	8	0,86	17,20	5,03
CPJ 10-.../... (outside)	10	0,88	17,60	5,03
IPJ 10-.../... (inside)	10	0,88	17,60	5,03
CPJ 125-.../... (outside)	12,5	0,91	18,20	5,03
IPJ 125-.../... (inside)	12,5	0,91	18,20	5,03

OUTSIDE CAPSULES



INSIDE CAPSULES

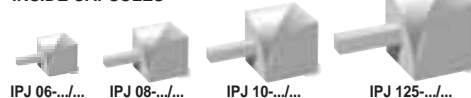

Available in the colours: 01-02-03-04-05-06-07-08-09-10-11-12-13-14-15-16-17-18-0106 (not available 19-20-21-22-23-24-25-26-27-28-29). The code of the selected colour must be added to the article code. E.g.: CPJ 06-.../... (chosen colour White) CPJ 06-01/20.

PROJOLLY MARBLE is a range of decorative products covered with a strong marbled PVC film in various finishes: white (Carrara) marble, green (Guatemalan) marble, beige (royal yellow) marble, blue marble, pink (Portuguese) marble, green (aquamarine) marble, light and dark travertine, in normal and shaded-off versions. **PROJOLLY MARBLE** facilitates installation, eliminating the fragile ceramic trim in completing the finish of wall coverings and vertical or horizontal coverings, etc. It strengthens the tile edge, thereby preventing chipping and breakages. Excellent resistance. Impeccable, precise work is ensured with a superior aesthetic effect.

PROJOLLY MARBLE

IMPACT-RESISTANT NON-TOXIC
MARBLED VINYL RESIN - 12 FINISHES

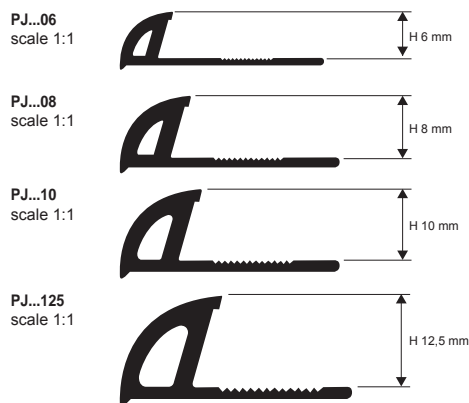

MARBLED NON-TOXIC VYNIL RESIN
bar length 2,7 LM - Pack. 40 Pcs - 108 LM

Article	H mm	€/LM	€/Pc
PJ... 06	6	2,21	5,97
PJ... 08	8	2,52	6,80
PJ... 10	10	2,72	7,34
PJ... 125	12,5	2,98	8,05

Available in the colours: MC - MB - MR - MA - MV - MVA - MAS - MBS - MRS - MVAS - MTC - MTS (MAB - MBC - MBO - MAM - MBD - MCRI - MCRC - MBDX - MGVC - MNA - MBPS - MVBL available upon request with a minimum quantity order of 5400 LM). The code of the selected colour must be added to the article code. E.g.: PJ... 06 (chosen colour white carrara) PJMC 06.

LAYING INSTRUCTIONS

1. Choose the PROJOLLY MARBLE with suitable height for the thickness of the covering. 2. Apply the adhesive onto the area of application of the profile. 3. Lay and align the profile, cut to the necessary length, pressing the perforated flange into the adhesive. 4. Lay the tiles, aligning them so that the top edge of the profile is flush with the tile. 5. Fill the profile/tile area of contact with adhesive to prevent the accumulation of water in any voids. **IMPORTANT:** Pay attention to the external edges of the Projolly Marble. They must be protected against agents such as adhesives and sealants and against grinding or scraping actions.

EXAMPLES OF LAYING

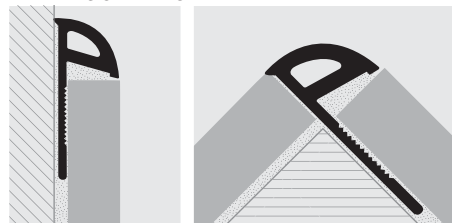

COLOURS

(for a precise assessment of colours and finishes, see the relative enclosed sheet)



AVAILABLE minimum quantity 5400 LM by colour and height (price and delivery time to be agreed)



PROJOLLY OPEN facilitates installation, eliminating the fragile ceramic trim. It is used for outside corners of tiles to complete the finish of wall coverings, decking, steps, bathtubs, etc. Impeccable, precise work is ensured with a superior aesthetic effect. It strengthens the tile edge, thereby preventing chipping and breakages. It is made in certified impact-resistant non-toxic PVC. Required by European standards for safety and hygiene in public and private environments.

PROJOLLY OPEN

IMPACT-RESISTANT NON-TOXIC
COLOURED VINYL RESIN



WHITE VINYL RESIN
bar length 2,7 LM - Pack. 80 Pcs - 216 LM

Article	H mm	€/LM	€/Pc
PJP 06-01	6	0,98	2,65
PJP 09-01	9	1,08	2,92

ARTICLES NOT FOR SALE SINGLY
OTHER COLOURS ON REQUEST FOR A MINIMUM OF 1080 LM

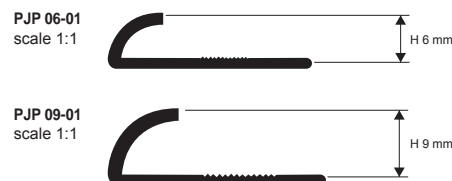

EXAMPLES OF LAYING

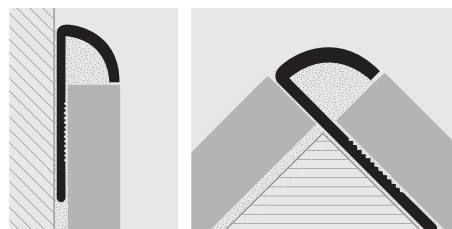

COLOURS

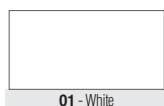

LAYING INSTRUCTIONS

1. Choose the PROJOLLY OPEN with suitable height for the thickness of the covering. 2. Apply the adhesive onto the area of application of the profile. 3. Lay and align the profile, cut to the necessary length, pressing the perforated flange into the adhesive. 4. Lay the tiles, aligning them so that the top edge of the profile is flush with the tile. 5. Fill the profile/tile area of contact with adhesive to prevent the accumulation of water in any voids.

PROJOLLY ECO

NON-TOXIC IMPACT RESISTANT
COLOURED RIGID VINYL RESIN

The **PROJOLLY ECO**, available in 18 COLOURS, with EAN BAR CODE, facilitates installation, eliminating the fragile ceramic trim. It is used for outside corners of tiles to complete the finish of wall coverings, decking, steps, bathtubs, etc. Impeccable, precise work is ensured with a superior aesthetic effect. It strengthens the tile edge, thereby preventing chipping and breakages. It is made in certified impact-resistant non-toxic PVC. Required by European standards for safety and hygiene in public and private environments. End caps and three-way inside and outside corner linking elements are available. (finishing nr 12 and 13 excluded).

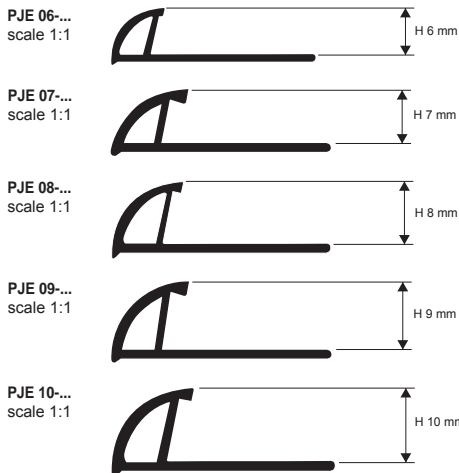

AVAILABLE H 12,5 mm PJE 125-...

EXAMPLES AND INSTRUCTIONS FOR LAYING METHODS

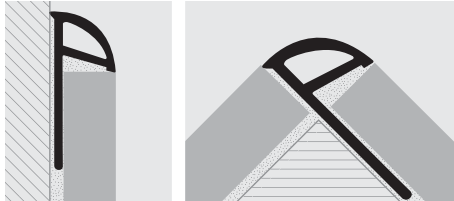

1. Choose the PROJOLLY ECO with suitable height for the thickness of the covering. 2. Apply the adhesive onto the area of application of the profile. 3. Lay and align the profile, cut to the necessary length, pressing the perforated flange into the adhesive. 4. Lay the tiles, aligning them so that the top edge of the profile is flush with the tile. 5. Fill the profile/tile area of contact with adhesive to prevent the accumulation of water in any voids.



COLOURED VINYL RESIN

bar length 2,7 LM - Pack. 80 Pcs - 216 LM

Article	H mm	€/LM	€/Pc
PJE 06-01/06/07/18	6	0,68	1,84
PJE 08-...	8	0,78	2,11
PJE 10-...	10	0,88	2,38
PJE 125-...	12,5	1,10	2,97

ARTICLES NOT FOR SALE SINGLY

H 6 mm available in 01-06-07-18, Other colours on demand.
Available in the colours: 01-02-03-04-05-06-07-08-09-10-11-12-13-14-15-16-17-18-0106 (19-20-21-22-23-24-25-26-27-28-29 available upon request with a minimum quantity order of 5400 LM).
The code of the selected colour must be added to the article code.
E.g.: PJE 08... (chosen colour White) PJE 08-01.



COLOURED VINYL RESIN

bar length 2,7 LM - Pack. 80 Pcs - 216 LM

Article	H mm	€/LM	€/Pc
PJE 07-...	7	0,73	1,97
PJE 09-...	9	0,83	2,24

ARTICLES NOT FOR SALE SINGLY

PRODUCTION ON REQUEST

MINIMUM QUANTITY 5400 LM by colour and height
(delivery time to be agreed)

Available in the colours: 01 - 02 - 03 - 04 - 05 - 06 - 07 - 08 - 09 - 10 - 11 - 12 - 13 - 14 - 15 - 16 - 17 - 18 - 19 - 20 - 21 - 22 - 23 - 24 - 25 - 26 - 27 - 28 - 29 - 0106 available with a minimum quantity order of 5400 LM.

The code of the selected colour must be added to the article code. E.g.: Pje 07-... (chosen colour White) PJE 07-01.

COLOURS

(for a precise assessment of colours and finishes, see the relative enclosed sheet)

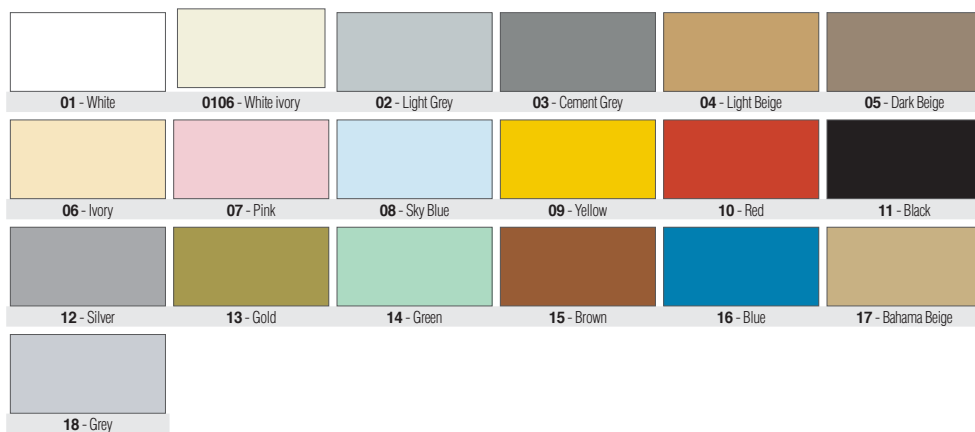

AVAILABLE minimum quantity 5400 LM by colour and height
(price and delivery time to be agreed)

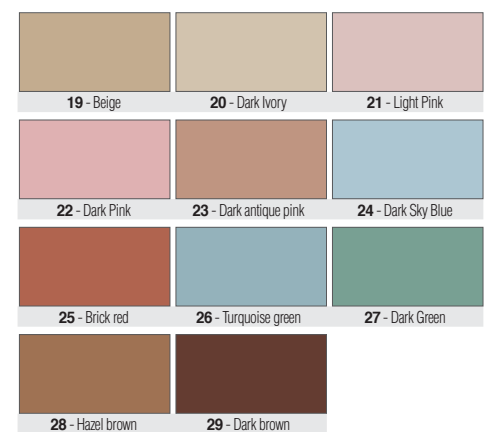

CAPSULES for tri-axial joints

COLOURED PLASTIC

COLOURED PLASTIC

Article	H mm	€/Pc	€/pack. 20 pcs	€/pack. 5 pcs
CPJE 06-01/06/07/18 /.. (outside)	6	0,76	15,20	3,99
CPJE 08-.../... (outside)	8	0,81	16,20	4,25
CPJE 10-.../... (outside)	10	0,86	17,20	4,52
CPJE 125-.../... (outside)	12,5	0,99	19,80	5,20

OUTSIDE CAPSULES



ARTICLES NOT FOR SALE SINGLY

Available in the colours: 01-02-03-04-05-06-07-08-09-10-11-12-13-14-15-16-17-18-0106 (not available 19-20-21-22-23-24-25-26-27-28-29). The code of the selected colour must be added to the article code.

E.g.: CPJE 08-.../... (chosen colour White) CPJE 08-01/20.

PROJOLLY ECO MARBLE is a range of decorative products covered with a strong marbled film in various finishes: white (Carrara) marble, green (Guatemalan) marble, beige (royal yellow) marble, blue marble, pink (Portuguese) marble, green (aquamarine) marble, light and dark travertine, in normal and shaded-off versions. **PROJOLLY ECO MARBLE** facilitates installation, eliminating the fragile ceramic trim in completing the finish of wall coverings, decking, bathtubs, etc. It strengthens the tile edge, thereby preventing chipping and breakages. Excellent resistance. Impeccable, precise work is ensured with a superior aesthetic effect, to be combined with **PROLITEL MARBLE**.

PROJOLLY ECO MARBLE

NON-TOXIC IMPACT RESISTANT
MARBLED VINYL RESIN



IMPACT-RESISTANT MARBLED VINYL RESIN
bar length 2,7 LM - Pack. 80 Pcs - 216 LM

Article	H mm	€/LM	€/Pc
PJE... 06	6	1,54	4,16 *
PJE... 08	8	1,64	4,43
PJE... 10	10	1,75	4,73

Available in the colours: MC - MB - MR - MA - MV - MVA - MAS - MBS - MRS - MVAS - MTC - MTS (MAB - MABC - MABO - MAM - MDB - MCI - MCRC - MDBX - MGV - MNA - MPSB - MVBL available upon request with a minimum quantity order of 5400 LM). The code of the selected colour must be added to the article code. E.g.: PJE... 06 (chosen colour white carrara) PJEMC 06.

IMPACT-RESISTANT MARBLED VINYL RESIN
bar length 2,7 LM - Pack. 80 Pcs - 216 LM

Article	H mm	€/LM	€/Pc
PJE... 07	7	1,64	4,43
PJE... 09	9	1,75	4,73

ARTICLES NOT FOR SALE SINGLY

PRODUCTION ON REQUEST

MINIMUM QUANTITY 5400 LM by colour and height
(delivery time to be agreed)

Available in the colours: MC - MB - MR - MA - MV - MVA - MAS - MBS - MRS - MVAS - MTC - MTS - MAB - MBC - MBO - MAM - MBD - MCRI - MCRC - MDBX - MGV - MGVC - MNA - MBPS - MVBL available with a minimum quantity order of 5400 LM. The code of the selected colour must be added to the article code. E.g.: PJE... 06 (chosen colour white carrara) PJEMC 06.

ARTICLES NOT FOR SALE SINGLY

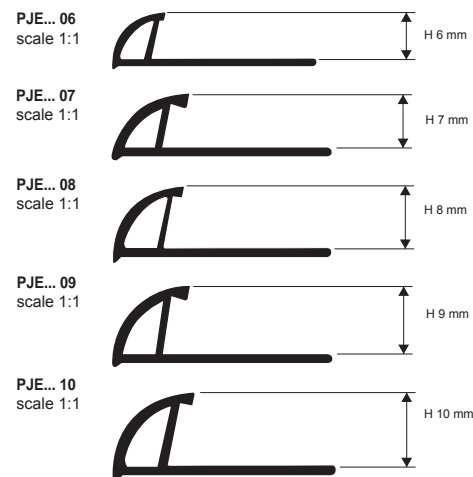

EXAMPLES AND INSTRUCTIONS FOR LAYING METHODS



1. Choose the PROJOLLYECO MARBLE with suitable height for the thickness of the covering. 2. Apply the adhesive onto the area of application of the profile. 3. Lay and align the profile, cut to the necessary length, pressing the perforated flange into the adhesive. 4. Lay the tiles, aligning them so that the top edge of the profile is flush with the tile. 5. Fill the profile/tile area of contact with adhesive to prevent the accumulation of water in any voids. **IMPORTANT:** Pay attention to the external edges of the Projolly Marble. They must be protected against agents such as adhesives and sealants and against grinding or scraping actions.

COLOURS

(for a precise assessment of colours and finishes, see the relative enclosed sheet)



AVAILABLE minimum quantity 5400 LM by colour and height (price and delivery time to be agreed)

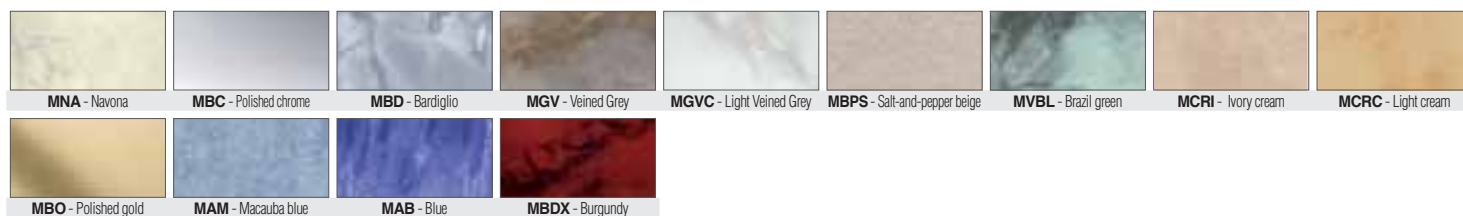

* = Upon request, delivery time to be agreed.

Prices are referred to whole packs. 10% increase for minimum orders of 10 pcs. 20% increase for orders of less than 10 pcs.

PROJOLLY TRIANGLE

POLISHED, SUPER POLISHED AND SATINED
STAINLESS STEEL AISI 304/1.4301-V2A

PROJOLLY TRIANGLE is a profile in polished, super polished and satined stainless steel AISI 304/1.4301-V2A with a triangular shape. It is suitable for protecting the outside corners of the coverings and for their perimetrical and vertical closing. Its particular section and the availability in different finishes and special pieces, as inside and outside capsules, end caps and junctions, make **PROJOLLY TRIANGLE** a much-sought profile that allows a perfect laying also in the environments where high mechanical stresses are provided.

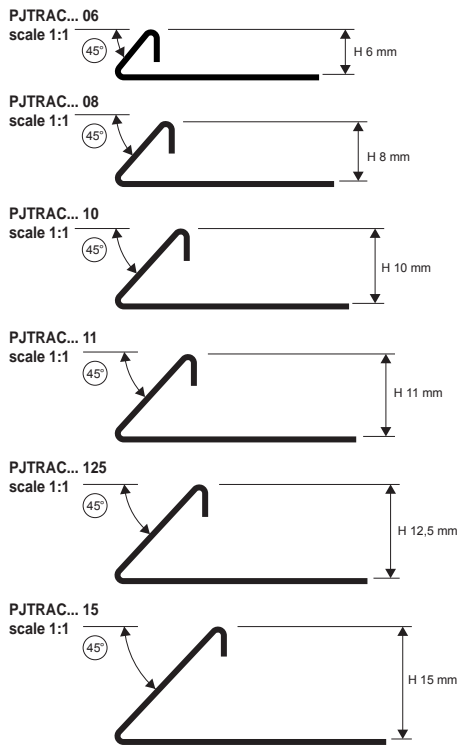

POLISHED STAINLESS STEEL AISI 304/1.4301-V2A
with protective film - bar length 2,7 LM - packaging 40 Pcs - 108 LM - 8/10 mm (H 12,5 mm - 15mm - packaging 20 Pcs - 54 LM)

Article	H mm	€/LM	€/PC
PJTRAC 06	6	7,70	20,79
PJTRAC 08	8	8,10	21,87
PJTRAC 10	10	8,50	22,95
PJTRAC 11	11	8,75	23,66
PJTRAC 125	12,5	9,10	24,57
PJTRAC 15	15	9,50	25,65

SATINED STAINLESS STEEL AISI 304/1.4301-V2A
bar length 2,7 LM - packaging 40 Pcs - 108 LM - 8/10 mm (H 12,5 mm - 15mm - packaging 20 Pcs - 54 LM)

Article	H mm	€/LM	€/PC
PJTRACS 06	6	8,90	24,03
PJTRACS 08	8	9,40	25,38
PJTRACS 10	10	9,80	26,46
PJTRACS 11	11	10,10	27,27
PJTRACS 125	12,5	10,50	28,35
PJTRACS 15	15	11,00	29,70

SUPER POLISHED STAINLESS STEEL AISI 304/1.4301-V2A thermo packed
bar length 2,7 LM - packaging 20 Pcs - 54 LM - 8/10 mm

Article	H mm	€/LM	€/PC
PJTRACML 06	6	10,40	28,08
PJTRACML 08	8	10,95	29,57
PJTRACML 10	10	11,50	31,05
PJTRACML 11	11	11,85	32,00
PJTRACML 125	12,5	12,30	33,21
PJTRACML 15	15	12,85	34,70



EXAMPLES AND INSTRUCTIONS FOR LAYING METHODS

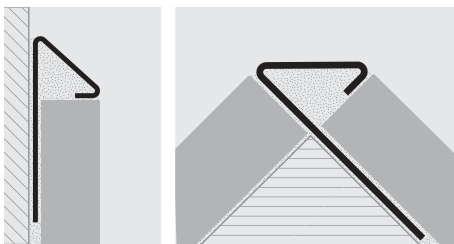

1. Choose PROJOLLY TRIANGLE according to the thickness of the tile and in the desired finish.
2. Cut PROJOLLY TRIANGLE to the desired length and apply the adhesive on the support where the profile will be laid.
3. Press the anchoring flange of PROJOLLY TRIANGLE into the adhesive.
4. Lay the tiles, aligning them with the profile and leaving a 2 mm joint.
5. Fill the joints between the profile and the tiles with plaster, in order to avoid water stagnation.

COLOURS



SUITABLE FOR USE IN CONTACT WITH FOODSTUFFS

CAPSULES, END CAPS and JOINTS

POLISHED, SUPER POLISHED and SATINED STAINLESS STEEL AISI 304/1.4301-V2A / PLASTIC

OUTSIDE/ INSIDE/ TRI-AXIAL CAPSULES AND END CAPS - POLISHED STAINLESS STEEL

Article	H mm	€/PC	€/Pack 10 pcs	€/Pack 2 pcs
CPJTRAC 06 ÷ 15 (outside)	06-08-10-11-12,5-15	11,30	113,00	23,75
IPJTRAC 06 ÷ 15 (inside)	06-08-10-11-12,5-15	11,30	113,00	23,75
CTPJTRAC 06 ÷ 15 (tri-axial)	06-08-10-11-12,5-15	14,70	147,00	30,87
TPJTRAC 06 ÷ 15 (caps)	06-08-10-11-12,5-15	3,50	35,00	7,50

Choose the desired packaging: E.g. CPJTRAC.../10 (pack 10 pcs)
CPJTRAC.../2 (pack 2 pcs)

Articles not for sale singly.

OUTSIDE/ INSIDE/ TRI-AXIAL CAPSULES AND END CAPS - SATINED STAINLESS STEEL

Article	H mm	€/PC	€/Pack 10 pcs	€/Pack 2 pcs
CPJTRACS 06 ÷ 15 (outside)	06-08-10-11-12,5-15	12,90	129,00	27,10
IPJTRACS 06 ÷ 15 (inside)	06-08-10-11-12,5-15	12,90	129,00	27,10
CTPJTRACS 06 ÷ 15 (tri-axial)	06-08-10-11-12,5-15	16,80	168,00	35,28
TPJTRACS 06 ÷ 15 (caps)	06-08-10-11-12,5-15	4,00	40,00	8,50

Choose the desired packaging: E.g. CPJTRACS.../10 (pack 10 pcs)
CPJTRACS.../2 (pack 2 pcs)

Articles not for sale singly.

OUTSIDE/ INSIDE/ TRI-AXIAL CAPSULES AND END CAPS - SUPER POLISHED STAINLESS STEEL

Article	H mm	€/PC	€/Pack 10 pcs	€/Pack 2 pcs
CPJTRACML 06 ÷ 15 (outside)	06-08-10-11-12,5-15	14,15	141,50	29,75
IPJTRACML 06 ÷ 15 (inside)	06-08-10-11-12,5-15	14,15	141,50	29,75
CTPJTRACML 06 ÷ 15 (tri-axial)	06-08-10-11-12,5-15	18,40	184,00	38,64
TPJTRACML 06 ÷ 15 (caps)	06-08-10-11-12,5-15	4,50	45,00	9,50

Choose the desired packaging: E.g. CPJTRACML.../10 (pack 10 pcs)
CPJTRACML.../2 (pack 2 pcs)

Articles not for sale singly.

JOINTS - PLASTIC

Article	H mm	€/PC	€/Pack 10 pcs	€/Pack 2 pcs
GIJTRA 06 ÷ 15/...	06-08-10-11-12,5-15	2,10	21,00	4,50

Choose the desired packaging: E.g. GIJTRA.../10 (pack 10 pcs)
GIJTRA.../2 (pack 2 pcs)

Articles not for sale singly.



CPJTRAC ...

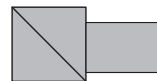

IPJTRAC ...

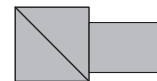

CTPJTRAC ...



TPJTRAC ...



GIJTRA ...

PROJOLLY TRIANGLE is a profile in anodised, polished and brushed aluminium, triangular shaped, suitable for protecting the outside corners of coverings and for their perimetrical and vertical closing. Its particular section and the availability in different finishes and special pieces, as inside and outside capsules, end caps and junctions, make **PROJOLLY TRIANGLE** a very elegant profile, easy to match with every type of covering and that allows a perfect pose.

PROJOLLY TRIANGLE

ANODISED, POLISHED
POLISHED BRUSHED ALUMINIUM



ANODISED ALUMINIUM (silver-titanium-gold)
thermo packed - bar length 2,7 LM - packaging 40 Pcs - 108 LM

POLISHED ALUMINIUM (chrome-titanium-gold)
thermo packed - bar length 2,7 LM - packaging 40 Pcs - 108 LM

Article	H mm	€/LM	€/PC
⊕ PJTRAA 08	8	4,25	11,48
⊕ PJTRAT 08	8	4,60	12,42
⊕ PJTRAO 08	8	4,35	11,75
⊕ PJTRAA 10	10	4,65	12,56
⊕ PJTRAT 10	10	5,10	13,77
⊕ PJTRAO 10	10	4,80	12,96
⊕ PJTRAA 125	12,5	5,25	14,18
⊕ PJTRAT 125	12,5	5,60	15,12
⊕ PJTRAO 125	12,5	5,35	14,45

Article	H mm	€/LM	€/PC
⊕ PJTRBC 08	8	7,15	19,31
⊕ PJTRBT 08	8	7,15	19,31
⊕ PJTRBO 08	8	7,15	19,31
⊕ PJTRBC 10	10	7,50	20,25
⊕ PJTRBT 10	10	7,50	20,25
⊕ PJTRBO 10	10	7,50	20,25
⊕ PJTRBC 125	12,5	8,50	22,95
⊕ PJTRBT 125	12,5	8,50	22,95
⊕ PJTRBO 125	12,5	8,50	22,95

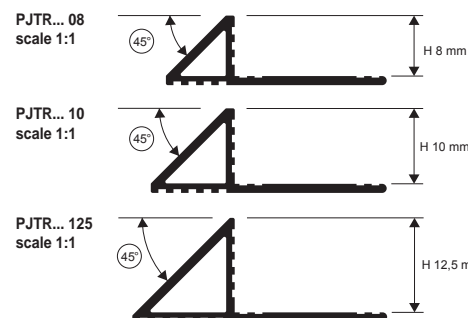

POLISHED BRUSHED ALUMINIUM (silver)
thermo packed - bar length 2,7 LM - packaging 40 Pcs - 108 LM

Article	H mm	€/LM	€/PC
⊕ PJTRBS 08	8	7,70	20,79
⊕ PJTRBS 10	10	8,30	22,41
⊕ PJTRBS 125	12,5	9,40	25,38

UPON REQUEST MAY BE REALISED IN OTHER FINISHES OF THE COLOUR CHART.
CONTACT OUR CUSTOMER SERVICE FOR MINIMAL QUANTITY, TIMING AND PRICE.

COLOURS

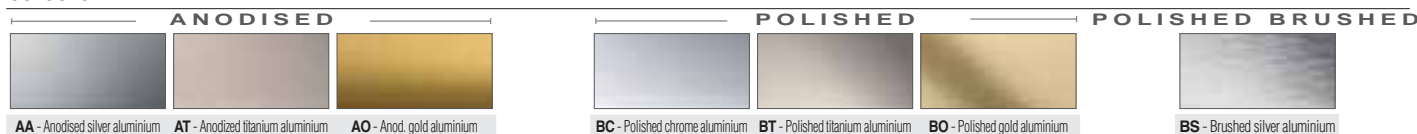

EXAMPLES AND INSTRUCTIONS FOR LAYING METHODS

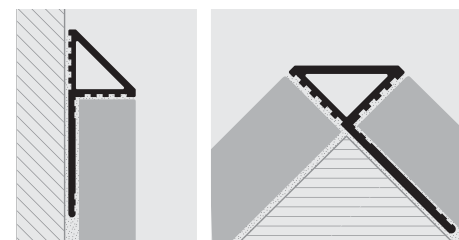

1. Choose PROJOLLY TRIANGLE according to the thickness of the tile and in the desired finish.
2. Cut PROJOLLY TRIANGLE to the desired length and apply the adhesive on the support where the profile will be laid.
3. Press the anchoring flange of PROJOLLY TRIANGLE into the adhesive.
4. Lay the tiles, aligning them with the profile and leaving a 2 mm joint.
5. Fill the joints between the profile and the tile with plaster in order to avoid water stagnation. Remove immediately all the remains of plaster from the surface of the profile.

CAPSULES, END CAPS and JOINTS

ANODISED, POLISHED, POLISHED BRUSHED ALUMINIUM / PLASTIC

OUTSIDE/ INSIDE/ TRI-AXIAL CAPSULES AND END CAPS - ANODISED ALUMINIUM

Article	H mm	€/PC	€/pack 10 pcs	€/pack 2 pcs
⊕ CPJTR... 08/... (outside)	8	11,30	113,00	23,75
⊕ IPJTR.. 08/... (inside)	8	11,30	113,00	23,75
⊕ CTPJTR... 08/... (tri-axial)	8	14,70	147,00	30,87
⊕ CPJTR... 10/...	10	11,30	113,00	23,75
⊕ IPJTR... 10/...	10	11,30	113,00	23,75
⊕ CTPJTR... 10/...	10	14,70	147,00	30,87
⊕ CPJTR... 125/...	12,5	11,30	113,00	23,75
⊕ IPJTR... 125/...	12,5	11,30	113,00	23,75
⊕ CTPJTR... 125/...	12,5	14,70	147,00	30,87
⊕ TPJTR... 08-10-125/... (caps)	8 - 10 - 12,5	3,50	35,00	7,50

Available in the colours : AA-AT-AO
Choose the desired packaging: E.g. CPJTRAA.../10 (pack 10 pcs)
CPJTRAA.../2 (pack 2 pcs) Articles not for sale singly.

OUTSIDE/ INSIDE/ TRI-AXIAL CAPSULES AND END CAPS - POLISHED ALUMINIUM

Article	H mm	€/PC	€/pack 10 pcs	€/pack 2 pcs
⊕ CPJTR... 08/... (outside)	8	12,90	129,00	27,00
⊕ IPJTR... 08/... (inside)	8	12,90	129,00	27,00
⊕ CTPJTR... 08/... (tri-axial)	8	16,80	168,00	35,28
⊕ CPJTR... 10/...	10	12,90	129,00	27,00
⊕ IPJTR.. 10/...	10	12,90	129,00	27,00
⊕ CTPJTR... 10/...	10	16,80	168,00	35,28
⊕ CPJTR... 125/...	12,5	12,90	129,00	27,00
⊕ IPJTR... 125/...	12,5	12,90	129,00	27,00
⊕ CTPJTR... 125/...	12,5	16,80	168,00	35,28
⊕ TPJTR... 08-10-125/... (caps)	8 - 10 - 12,5	4,00	45,00	8,50

Available in the colours : BC-BT-BO.
Choose the desired packaging: E.g. CPJTRBC.../10 (pack 10 pcs)
CPJTRBC.../2 (pack 2 pcs) Articles not for sale singly.

OUTSIDE/ INSIDE/ TRI-AXIAL CAPSULES AND END CAPS - POLISHED BRUSHED ALUM.

Article	H mm	€/PC	€/pack 10 pcs	€/pack 2 pcs
⊕ CPJTRBS 08/... (outside)	8	14,15	141,50	29,75
⊕ IPJTRBS 08/... (inside)	8	14,15	141,50	29,75
⊕ CTPJTRBS 08/... (tri-axial)	8	18,40	184,00	38,64
⊕ CPJTRBS 10/...	10	14,15	141,50	29,75
⊕ IPJTRBS 10/...	10	14,15	141,50	29,75
⊕ CTPJTRBS 10/...	10	18,40	184,00	38,64
⊕ CPJTRBS 125/...	12,5	14,15	141,50	29,75
⊕ IPJTRBS 125/...	12,5	14,15	141,50	29,75
⊕ CTPJTRBS 125/...	12,5	18,40	184,00	38,64
⊕ TPJTRBS 08-10-125/... (caps)	8 - 10 - 12,5	4,50	45,00	9,50

Articles not for sale singly.

JOINTS - PLASTIC

Article	H mm	€/PC	€/pack 10 pcs	€/pack 2 pcs
⊕ GIJTRA 8-10-125/...	8-10-12,5	2,10	21,00	4,50

Choose the desired packaging: E.g. GIJTRA.../10 (pack 10 pcs)
GIJTRA.../2 (pack 2 pcs)
Articles not for sale singly.

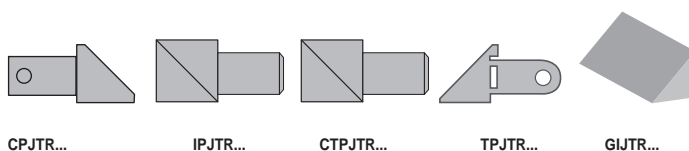

⊕ = News 2015 available from April



Prices are referred to whole packs. 10% increase for minimum orders of 10 pcs. 20% increase for orders of less than 10 pcs.

PROINTER AC

POLISHED, SUPER POLISHED AND SATINED
STAINLESS STEEL AISI 304/1.4301 V2A

PROINTER AC is a small inner connector for tile, wood and marble coverings and floors. It facilitates cleaning by preventing dust, dirt and moisture penetrating corners, and allows the necessary expansion of inner corners in relation to an adjacent structure. It is durable and aesthetically pleasing. Available in several sizes and finishes. In AISI stainless steel 304 - 1.4301 10/10 thickness in the following finishes: Polished - Super Polished - Mirror Line - Satin. The **PROINTER AC** is very resistant to corrosion and oxidation, detergents, solvents and acids. It can also be used to join coverings with baths, sinks and toilets, and shower units by applying silicone to the upper and lower parts of the square, preventing the appearance of ugly silicone that has been yellowed and blackened by time.

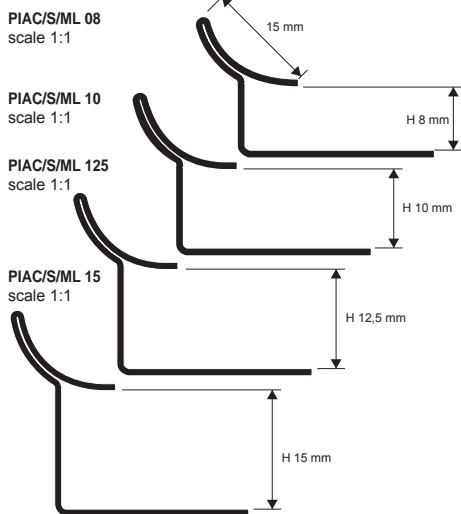

POLISHED STAINLESS STEEL AISI 304/1.4301 V2A with protective film
bar length 2,7 LM - Pack. 20 Pcs - 54 LM - 10/10 mm

Article	H mm	€/LM	€/Pc
PIAC 08	8	11,71	31,62
PIAC 10	10	12,38	33,43
PIAC 125	12,5	15,78	42,61
PIAC 15	15	17,53	47,33



SATINED STAINLESS STEEL AISI 304/1.4301 with protective film
bar length 2,7 LM - Pack. 20 Pcs - 54 LM - 10/10 mm

Article	H mm	€/LM	€/Pc
PIACS 08	8	14,68	39,64
PIACS 10	10	16,83	45,44
PIACS 125	12,5	18,95	51,17
PIACS 15	15	21,03	56,78

EXAMPLES AND INSTRUCTIONS FOR LAYING METHODS

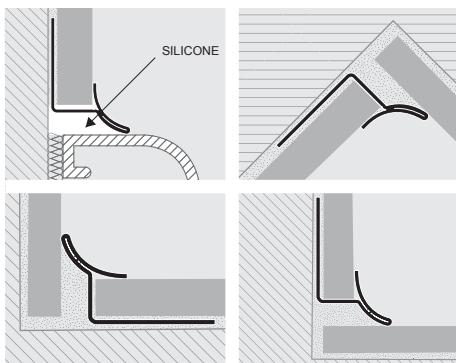

1. Choose the PROINTER AC with suitable height for the thickness of the covering. 2. Apply the adhesive onto the area of application of the profile. 3. Lay and align the profile, cut to the necessary length, pressing the perforated flange into the adhesive. 4. Lay the tiles under the curvature of PROINTER AC and align them so that the outer curved part of the profile covers the perpendicular tiles. 5. Fill the profile/tile area of contact with adhesive to prevent the accumulation of water in any voids. (When laying on bathtubs, sanitary ware and shower trays, fill the rear part of the profile on both sides with silicone to prevent infiltration of water).

SUPER POLISHED STAINLESS STEEL AISI 304/1.4301-V2A thermo packed
bar length 2,7 LM - Pack. 20 Pcs - 54 LM - 10/10 mm

Article	H mm	€/LM	€/Pc
PIACML 08	8	15,20	41,04
PIACML 10	10	17,51	47,28
PIACML 125	12,5	19,72	53,24
PIACML 15	15	21,88	59,08

PRODUCTION ON REQUEST

SUITABLE FOR USE IN CONTACT WITH FOODSTUFFS

COLOURS

(for a precise assessment of colours and finishes, see the relative enclosed sheet)



JOINTS

VARNISHED PLASTIC POLISHED/ SATINED STEEL EFFECT



COLOURS



To facilitate and complete the application of **PROINTER** in PIAC, PIACML and PIACS stainless steel, internal and external corners are available to seamlessly connect the wall lining to ceramic tiles, wooden floors, parquet, etc. PROINTER can also be used to connect PROJOLLY.

INSIDE, OUTSIDE, THREE-WAY CORNER JOINTS VARNISHED PLASTIC for POLISHED STAINLESS STEEL - Pack. 10 Pcs

Article	€/Pc	€/pack
REPIAC (outside corner)	6,16	61,60
RRIPIAC (two ways corner)	6,16	61,60
RITPIAC (three-ways corner)	6,16	61,60

INSIDE, OUTSIDE, THREE-WAY CORNER JOINTS VARNISHED PLASTIC for SATINED STAINLESS STEEL - Pack. 10 Pcs

Article	€/Pc	€/pack
REPIACS (outside corner)	6,16	61,60
RRIPIACS (two ways corner)	6,16	61,60
RITPIACS (three-ways corner)	6,16	61,60



PRINTER AL is a small inner aluminium connector for tile, wood and marble coverings and floors. It facilitates cleaning by preventing dust, dirt and moisture penetrating corners, and allows the necessary expansion of inner corners in relation to an adjacent structure. Available in four finishes: 2 Shiny: Polished Chrome and Gold and 2 matt Silk and Gold.

PRINTER AL

ANODISED POLISHED ALUMINIUM



GOLD or SILVER ANODISED ALUMINIUM thermo packed
bar length 2,7 LM - Pack. 40 Pcs - 108 LM

Article	H mm	€/LM	€/Pc
PIAA 08	8	5,34	14,42
PIAO 08	8	5,34	14,42
PIAA 10	10	5,70	15,39
PIAO 10	10	5,70	15,39

GOLD or CHROMED POLISHED ALUMINIUM thermo packed
bar length 2,7 LM - Pack. 40 Pcs - 108 LM

Article	H mm	€/LM	€/Pc
PIBC 08	8	9,00	24,30
PIBO 08	8	9,00	24,30
PIBC 10	10	10,53	28,43
PIBO 10	10	10,53	28,43

PL... 08
scale 1:1

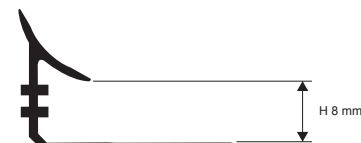

PL... 10
scale 1:1



EXAMPLES AND INSTRUCTIONS FOR LAYING METHODS

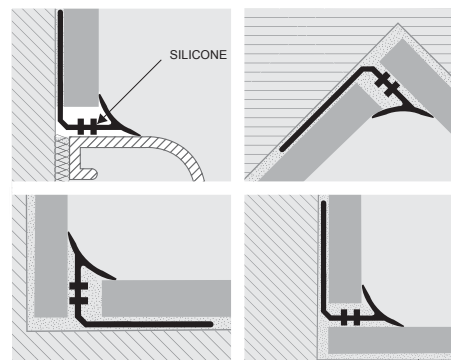

1. Choose the PRINTER AL with suitable height for the thickness of the covering. 2. Apply the adhesive onto the area of application of the profile. 3. Lay and align the profile, cut to the necessary length, pressing the perforated flange into the adhesive. 4. Lay the tiles under the curvature of PRINTER AL and align them so that the outer curved part of the profile covers the perpendicular tiles. 5. Fill the profile/tile area of contact with adhesive to prevent the accumulation of water in any voids. (When laying on bathtubs, sanitary ware and shower trays, fill the rear part of the profile on both sides with silicone to prevent infiltration of water). **IMPORTANT:** Pay attention to the external edges of the Printer. They must be protected against agents such as adhesives and sealants and against grinding or scraping actions.

COLOURS

(for a precise assessment of colours and finishes, see the relative enclosed sheet)

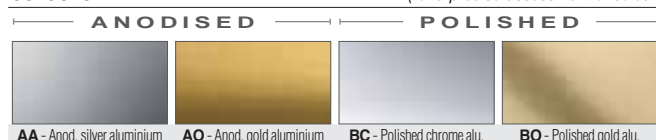

JOINTS

VARNISHED PLASTIC ANODISED AND POLISHED ALUMINIUM EFFECT

To facilitate and complete the application of **PRINTER** in PIAA - PIAO - PIBC - PIBO aluminium internal and external corners are available to seamlessly connect the wall lining to ceramic tiles, wooden floors, parquet, etc. The connections are available with different finishes: Polished chrome & gold for PIBC - PIBO, anodised silver & gold for PIAA - PIAO.

PRINTER can also be used to connect **PROJOLLY**.

INSIDE, OUTSIDE, THREE-WAY CORNER JOINTS

VARNISHED PLASTIC for ALUMINIUM - Pack. 10 Pcs

Article	€/Pc	€/pack
REPI... (outside corner)	6,16	61,60
RIPI... (inside corner)	6,16	61,60
RITPI... (three-way corner)	6,16	61,60

Available in the finishes: BC - BO - AA - AO. The code of the selected colour must be added to the article code.

Example for metal: RIPI... (chosen finish Polished Chrome BC) RIPIBC.



COLOURS

(for a precise assessment of colours and finishes, see the relative enclosed sheet)

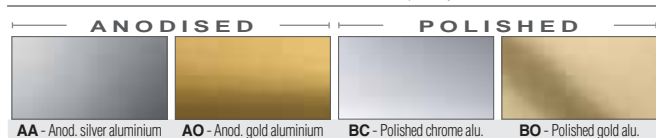

PROINTER

IMPACT-RESISTANT NON-TOXIC VINYL RESIN (PVC) - 19 COLOURS

PROINTER is a small cove-shaped inside joint for installing between tiled floors and abutting surfaces. It facilitates cleaning, preventing dust, dirt and damp from accumulating in the corner, and allows the necessary expansion in inside corners adjoining another structure. This attractive joint comes in various colours and sizes and is made in non-toxic, impact-resistant, detergent and solvent-resistant vinyl resin. It may also be used for joining wall coverings to the bathtub, sanitary fittings and shower tray with the application of silicone on the back of the profile.

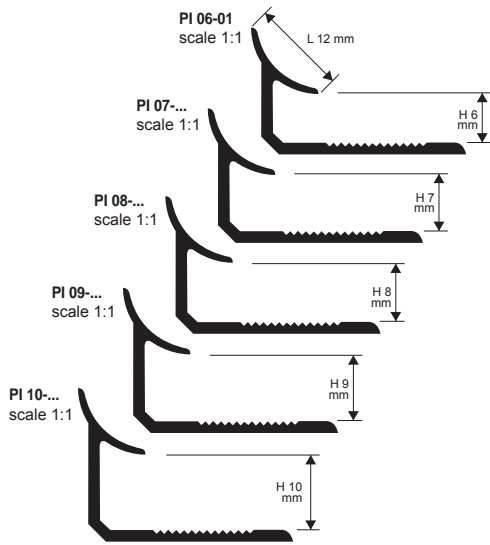

PI 07-... e PI 09-...
PRODUCTION ON REQUEST
MINIMUM QUANTITY 5400 LM by colour and height
(delivery time to be agreed)



EXAMPLES AND INSTRUCTIONS FOR LAYING METHODS

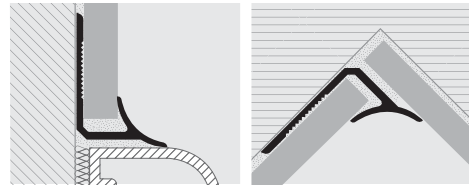

1. Choose the PROINTER with suitable height for the thickness of the covering. 2. Apply the adhesive onto the area of application of the profile. 3. Lay and align the profile, cut to the necessary length, pressing the perforated flange into the adhesive. 4. Lay the tiles under the curvature of PROINTER and align them so that the outer curved part of the profile covers the perpendicular tiles. 5. Fill the profile/tile area of contact with adhesive to prevent the accumulation of water in any voids. (When laying on bathtubs, sanitary ware and shower trays, fill the rear part of the profile on both sides with silicone to prevent infiltration of water).

NON-TOXIC IMPACT-PROOF VINYL RESIN

bar length 2,7 LM - Pack. 54 LM (colour white Pack. 108 LM)

Article	H mm	€/LM	€/Pc
PI 06-01	6	1,08	2,92 *
PI 07-...	7	1,16	3,13
PI 08-...	8	1,24	3,35
PI 09-...	9	1,32	3,56
PI 10-...	10	1,41	3,81

H 6 mm available in White. Other colours on demand.
Available in the colours: 01-02-03-04-05-06-07-08-09-10-11-12-13-14-15-16-17-18-0106 (19-20-21-22-23-24-25-26-27-28-29 available upon request with a minimum quantity order of 5400 LM).
The code of the selected colour must be added to the article code.
E.g.: PI 06-... (chosen colour White) PI 06-01.

WHITE NOT FOR SALE SINGLY

COLOURS

(for a precise assessment of colours and finishes, see the relative enclosed sheet)



AVAILABLE minimum quantity 5400 LM by colour and height
(price and delivery time to be agreed)



JOINTS

19 COLOURS



To facilitate and complete the application of **PROINTER** in PL. plastic internal and external corners are available to seamlessly connect the wall lining to ceramic tiles, wooden floors, parquet, etc. The connections are available with different finishes: all the solid colour finishes (18 finishes) for non-toxic, impact-resistant, vinyl resin **PROINTER**. **PROINTER** can also be used to connect **PROJOLLY**.

INSIDE, OUTSIDE, THREE-WAYS CORNER JOINTS

VARNISHED PLASTIC (Vinyl Resin) - Pack. 10 Pcs

Article	€/Pc	€/pack
REPI ... (outside corner)	4,01	40,10
RIFI ... (inside corner)	4,01	40,10
RITPI ... (three-way corner)	4,01	40,10

Available in the colours: 01 & 18 and 0106. The code of the selected colour must be added to the article code.
Example: RIFI ... (chosen colour Ivory 06) RIFI 06.

COLOURS

(for a precise assessment of colours and finishes, see the relative enclosed sheet)

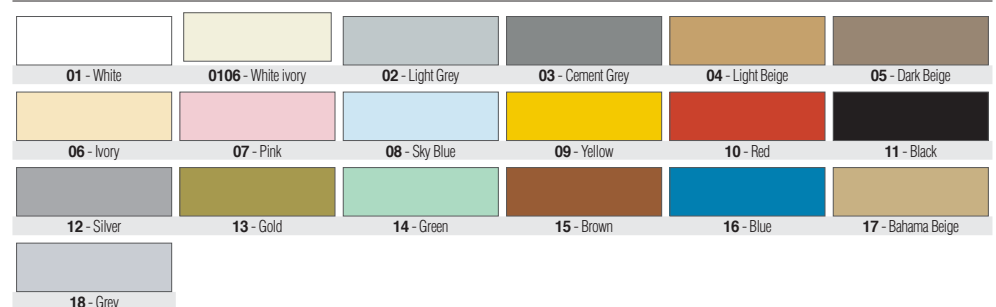

* = Other colours upon request, price and delivery time to be agreed.

Prices are referred to whole packs. 10% increase for minimum orders of 10 pcs. 20% increase for orders of less than 10 pcs.

PRINTER MARBLE. A range of transition profiles made in non-toxic impact-resistant PVC coated with a strong decorative marbled PVC film in 12 finishes, designed to comply with hygiene standards. Ideal for joining inside corner joints between wall coverings in tiles and marble, allowing the necessary expansion in the inside corners to an adjacent structure. The profile with punched/perforated flange must be applied under the wall or floor tile. This profile makes cleaning easy by preventing dust, dirt and damp from accumulating in the corner. Available in the heights 6, 8 and 10 mm Match with **PROJOLLY MARBLE** (for outside corners and edges) and with **PROLISTEL MARBLE** (strips/pencil strips).

PRINTER MARBLE

IMPACT-RESISTANT NON-TOXIC
MARBLED VINYL RESIN



IMPACT RESISTANT MARBLED NON-TOXIC VYNIL RESIN
bar length 2,7 LM - Pack. 40 Pcs - 108 LM

Article	H mm	€/LM	€/Pc
PI... 07	7	3,07	8,29
PI... 08	8	3,12	8,42
PI... 09	9	3,18	8,59
PI... 10	10	3,24	8,75

PRODUCTION ON REQUEST

PI 07-... e PI 09-...

PRODUCTION UPON REQUEST

MINIMUM QUANTITY 5400 LM by colour and height
(delivery time to be agreed)

Available in the colours: MC-MB-MR-MA-MV-MVA-MAS-MBS-MRS-MVAS-MTC-MTS (MAB - MBC - MBO - MAM - MBD - MCRI - MCRC - MBDX - MGVC - MGVC - MNA - MBPS - MVBL available upon request with a minimum quantity order of 5400 LM).

The code of the selected colour must be added to the article code. E.g.: PI... 07 (chosen colour White Carrara) PIMC 07.

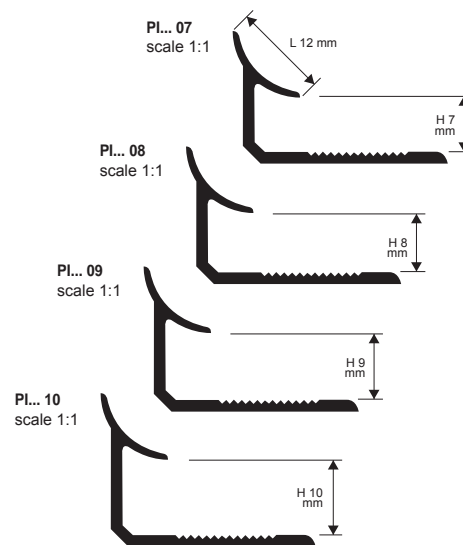

EXAMPLES AND INSTRUCTIONS FOR LAYING METHODS

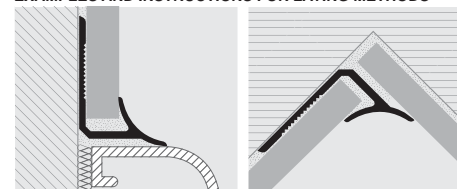

1. Choose the PRINTER with suitable height for the thickness of the covering.
2. Apply the adhesive onto the area of application of the profile.
3. Lay and align the profile, cut to the necessary length, pressing the perforated flange into the adhesive.
4. Lay the tiles under the curvature of PRINTER and align them so that the outer curved part of the profile covers the perpendicular tiles.
6. Fill the profile/tile area of contact with adhesive to prevent the accumulation of water in any voids. (When laying on bathtubs, sanitary ware and shower trays, fill the rear part of the profile on both sides with silicone to prevent infiltration of water).

COLOURS

(for a precise assessment of colours and finishes, see the relative enclosed sheet)



AVAILABLE minimum quantity 5400 LM by colour and height (price and delivery time to be agreed)



PROTERMINAL

POLISHED AND SATINED
STAINLESS STEEL AISI 304/1.4301-V2A

PROTERMINAL is a professional edging profile used mainly to join similar or different floor materials (e.g. tiles/tiles – tiles/parquet/ marble/laminates/carpeting /linoleum, etc.) of differing thickness.

PROTERMINAL in stainless steel is also used to protect steps and decking, as a floor edging profile and skirting covering. Match with **PROLISTEL** strips in stainless steel AISI 304-1.4301 V2A with polished or satin finish and in aluminium with anodised or polished chrome finish.

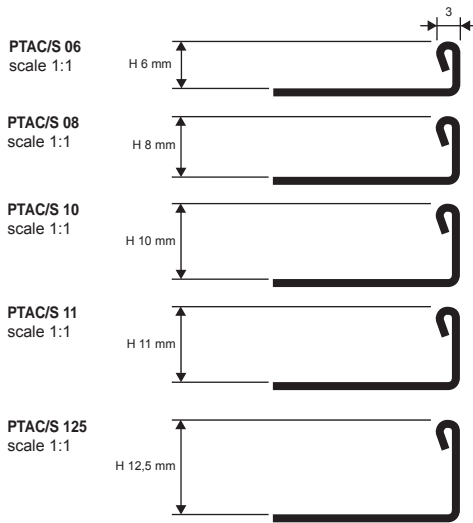

EXAMPLES AND INSTRUCTIONS FOR LAYING METHODS

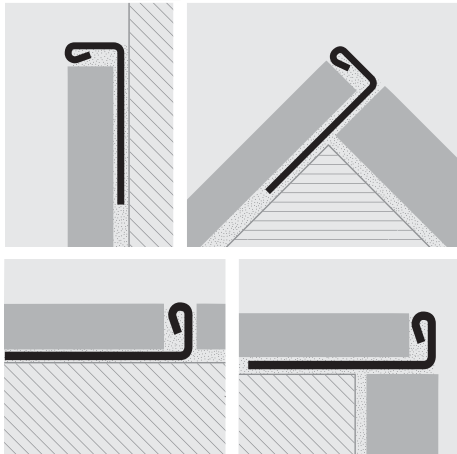

1. Choose the PROTERMINAL with the same height as the thickness of the covering. 2. Apply the adhesive onto the area of application of the profile. 3. Lay and align the profile pressing the perforated flange into the adhesive. 4. Lay the tiles, aligning them so that the top edge of the profile is flush with the tile. 5. Use the adhesive to seal any empty interstices.



POLISHED STAINLESS STEEL AISI 304/1.4301-V2A with protective film
bar length 2,7 LM - packaging 40 Pcs - 108 LM (H 12,5 mm 81 LM) - 10/10 mm

Article	H mm	€/LM	€/Pc
PTAC 06	6	7,65	20,66
PTAC 08	8	7,91	21,36
PTAC 10	10	8,32	22,46
PTAC 11	11	8,47	22,87
PTAC 125	12,5	8,63	23,30

SATINED STAINLESS STEEL AISI 304/1.4301-V2A with protective film
bar length 2,7 LM - packaging 40 Pcs - 108 LM (H 12,5 mm 81 LM) - 10/10 mm

Article	H mm	€/LM	€/Pc
PTACS 06	6	9,45	25,52
PTACS 08	8	9,76	26,35
PTACS 10	10	10,12	27,32
PTACS 11	11	10,27	27,73
PTACS 125	12,5	10,48	28,30



CURVE available, see page 172

COLOURS



(for a precise assessment of colours and finishes, see the relative enclosed sheet)

© 2011 All rights reserved by Progress Profiles. Printed in Italy

PROTERMINAL

POLISHED STAINLESS STEEL
AIS I 316/1.4404-V4A

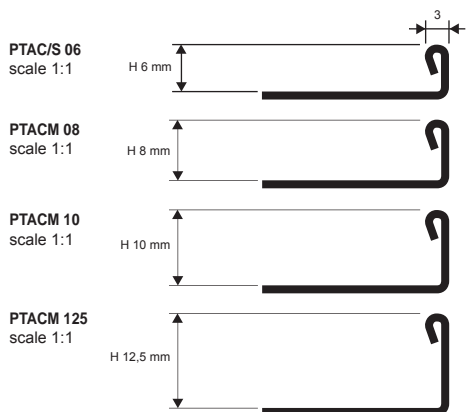

POLISHED STAINLESS STEEL AISI 316/1.4404-V4A with protective film
bar length 2,7 LM - packaging 40 Pcs - 108 LM (H 12,5 mm 81 LM) - 10/10 mm

Article	H mm	€/LM	€/Pc
PTACM 06	6	8,83	23,84
PTACM 08	8	9,04	24,41
PTACM 10	10	9,50	25,65
PTACM 125	12,5	10,48	28,30

COLOURS



(for a precise assessment of colours and finishes, see the relative enclosed sheet)

SUITABLE FOR USE IN CONTACT WITH FOODSTUFFS

Prices are referred to whole packs. 10% increase for minimum orders of 10 pcs. 20% increase for orders of less than 10 pcs.

PROTERMINAL is a professional edging profile used mainly to join similar or different floor materials (e.g. tiles/tiles – tiles/parquet/ marble/granite, etc.) of differing thickness.

PROTERMINAL in chromed brass is mainly used to protect and decorate the outside corners of tile coverings. The particular shape and design of the profile protect the tile edge and absorb any stress.



CHROMED BRASS thermo packed
bar length 2,7 LM - Pack. 20 Pcs - 54 LM

Article	H mm	€/LM	€/Pc
PTOC 06	6	14,89	40,20
PTOC 08	8	15,51	41,88
PTOC 10	10	15,82	42,71
PTOC 125	12,5	16,33	44,09

COLOURS



OC - Chromed brass

(for a precise assessment of colours and finishes, see the relative enclosed sheet)

PROTERMINAL

CHROMED BRASS

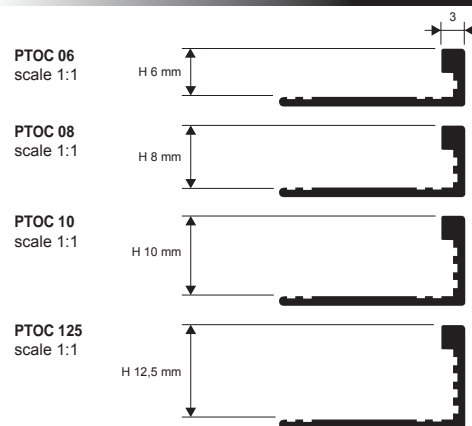

EXEMPLES OF LAYING

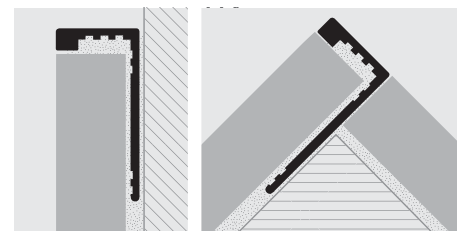

PROTERMINAL

ANODISED ALUMINIUM

PROTERMINAL is a professional edging profile designed to protect and decorate the outside corners of tile, mosaic and marble coverings of differing thickness.

PROTERMINAL in aluminium is also used to join different floor materials and to protect steps and decking. Excellent as the edging trim skirtings and for bathroom and kitchen wall coverings. Match with **PROLISTEL ALL** strips in anodised aluminium with silver and polished chrome finish and with **PROLISTEL ACC** strips in AISI 304-1.4301 stainless steel with polished or satin finish.



ANODISED SILVER / GOLD ALUMINIUM thermo packed
bar length 2,7 LM - Pack. 40 Pcs - 108 LM

Article	H mm	€/LM	€/Pc
PTAO 06 (Anod. gold)	6	3,24	8,75
PTAA 06 (Anod. silver)	6	3,24	8,75
PTAO 08 (Anod. gold)	8	3,29	8,88
PTAA 08 (Anod. silver)	8	3,29	8,88
PTAO 10 (Anod. gold)	10	3,49	9,42
PTAA 10 (Anod. silver)	10	3,49	9,42
PTAO 11 (Anod. gold)	11	3,80	10,26
PTAA 11 (Anod. silver)	11	3,80	10,26
PTAO 125 (Anod. gold)	12,5	4,01	10,83
PTAA 125 (Anod. silver)	12,5	4,01	10,83
PTAA 15 (Anod. silver)	15	4,26	11,50
PTAA 20 (Anod. silver)	20	4,98	13,45

ANODISED BLACK / TITANIUM / COPPER ALUMINIUM thermo packed - bar length 2,7 LM - Pack. 40 Pcs - 108 LM

Article	H mm	€/ML	€/Pce
PTAT 08 (anod. titanium)	8	4,50	12,15
PTAR 08 (anod. copper)	8	4,50	12,15
PTNE 08 (anod. black)	8	4,50	12,15
PTAT 10 (anod. titanium)	10	4,70	12,69
PTAR 10 (anod. copper)	10	4,70	12,69
PTNE 10 (anod. black)	10	4,70	12,69
PTAT 11 (anod. titanium)	11	4,80	12,96
PTAT 125 (anod. titanium)	12,5	4,95	13,37
PTAR 125 (anod. copper)	12,5	4,95	13,37
PTNE 125 (anod. black)	12,5	4,95	13,37

UPON REQUEST MAY BE REALISED IN OTHER FINISHES OF THE COLOUR CHART. CONTACT OUR CUSTOMER SERVICE FOR MINIMAL QUANTITY, TIMING AND PRICE.

COLOURS

(for a precise assessment of colours and finishes, see the relative enclosed sheet)

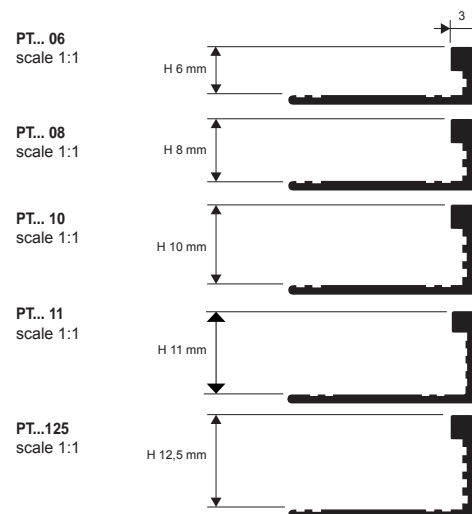

EXEMPLES AND INSTRUCTIONS FOR LAYING METHODS

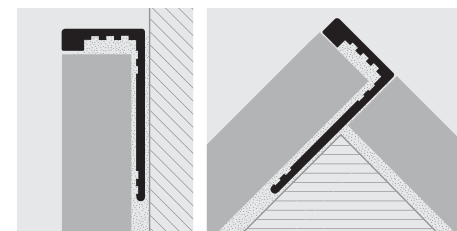

1. Choose the PROTERMINAL with suitable height for the thickness of the covering. 2. Apply the adhesive onto the area of application of the profile. 3. Lay and align the profile, cut to the necessary length, pressing the perforated flange into the adhesive. 4. Lay the tiles, aligning them so that the top edge of the profile is flush with the tile. 5. Fill the profile/tile area of contact with adhesive to prevent the accumulation of water in any voids. **IMPORTANT:** Pay attention to the external edges of the aluminium PROTERMINAL. They must be protected against agents such as adhesives and sealants and against grinding or scraping actions.

PROTERMINAL

POLISHED BRUSHED ALUMINIUM ALUMINIUM AND COATED ALUMINIUM (200°) 10 COLOURS

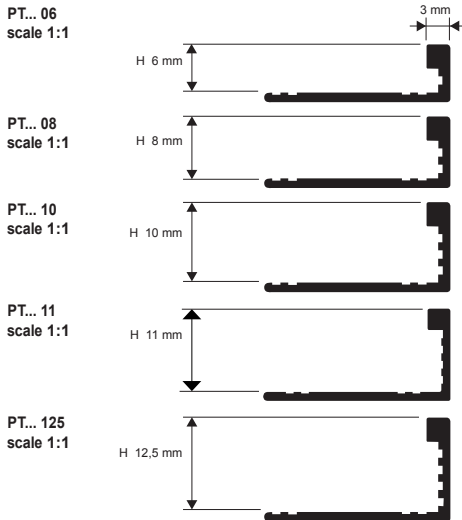

EXAMPLES AND INSTRUCTIONS FOR LAYING METHODS

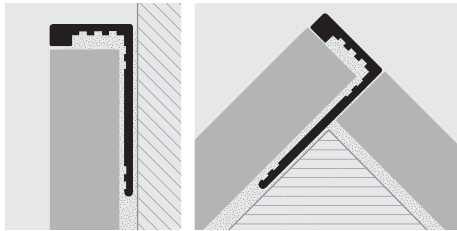

1. Choose the PROTERMINAL with suitable height for the thickness of the covering. 2. Apply the adhesive onto the area of application of the profile. 3. Lay and align the profile, cut to the necessary length, pressing the perforated flange into the adhesive. 4. Lay the tiles, aligning them so that the top edge of the profile is flush with the tile. 5. Fill the profile/tile area of contact with adhesive to prevent the accumulation of water in any voids. **IMPORTANT:** Pay attention to the external edges of the aluminium PROTERMINAL. They must be protected against agents such as adhesives and sealants and against grinding or scraping actions.

= News 2015 available from January

PROTERMINAL is a professional edging profile designed to protect and decorate the outside corners of tile, mosaic and marble coverings of differing thickness. **PROTERMINAL** in aluminium is also used to join different floor materials and to protect steps and decking. Excellent as the edging trim baseboards and for bathroom and kitchen wall coverings. Match with **PROLISTEL ALL** strips in anodised aluminium with silver and polished chrome finish and with **PROLISTEL ACC** strips in AISI 304-1.4301 stainless steel with polished or satin finish.



POLISHED ALUMINIUM (chrome-titanium-black-gold) thermo packed bar length 2,7 LM - Pack. 40 Pcs - 108 LM

Article	H mm	€/LM	€/Pc
PTBC 06	6	6,62	17,87
PTBO 06	6	6,62	17,87
PTBC 08	8	6,88	18,58
PTBO 08	8	6,88	18,58
PTBN 08	8	7,50	20,25
PTBT 08	8	7,50	20,25
PTBR 08	8	7,50	20,25
PTBC 10	10	7,03	18,98
PTBO 10	10	7,03	18,98
PTBN 10	10	7,80	21,06
PTBT 10	10	7,80	21,06
PTBR 10	10	7,80	21,06
PTBC 11	11	7,20	19,44
PTBO 11	11	7,20	19,44
PTBT 11	11	8,00	21,60
PTBC 125	12,5	7,39	19,95
PTBO 125	12,5	7,39	19,95
PTBN 125	12,5	8,30	22,41
PTBT 125	12,5	8,30	22,41
PTBR 125	12,5	8,30	22,41

TUSCANY LINE thermo packed bar length 2,7 LM - packaging 40 Pcs - 108 LM

Article	H mm	€/LM	€/Pc
PTA 08-...	8	15,50	41,85
PTA 10-...	10	15,80	42,66
PTA 125-...	12,5	16,16	43,61

Available in the finishes: 03TU - 05TU - 20TU.
The code of the selected colour must be added to the article code.
E.g.: PTA 08-... (chosen finish 03TU-Tuscany grey)
PTA 08-03TU.



BRUSHED ALUMINIUM (silver copper-titanium-black) thermo packed bar length 2,7 LM - Pack. 40 Pcs - 108 LM

Article	H mm	€/LM	€/Pc
PTBS 08	8	7,20	19,44
PTTS 08	8	8,10	21,87
PTNS 08	8	8,10	21,87
PTRS 08	8	8,10	21,87
PTBS 10	10	7,65	20,66
PTTS 10	10	8,40	22,68
PTNS 10	10	8,40	22,68
PTRS 10	10	8,40	22,68
PTBS 11	11	7,90	21,33
PTTS 11	11	8,75	23,63
PTBS 125	12,5	8,20	22,14
PTTS 125	12,5	9,10	24,57
PTNS 125	12,5	9,10	24,57
PTRS 125	12,5	9,10	24,57

COATED ALUMINIUM thermo packed bar length 2,7 LM - pack. 20 Pcs - 54 LM (White colour 40 Pc -108 LM)

Article	H mm	€/LM	€/Pc
PTA 06-01	6	4,11	11,10
PTA 08-...	8	4,21	11,37
PTA 10-...	10	4,57	12,34
PTA 11-01	11	4,75	12,83
PTA 125-01	12,5	4,93	13,31

H 8 and H 10 available in the colours: 01 - 0106 - 02 - 03 - 0211 - 0311 - 06 - 10 - 11 - 17.
The code of the selected colour must be added to the article code.
E.g.: PTA 08-... (chosen colour Klinker Red) PTA 08-10.

COLOURS

(for a precise assessment of colours and finishes, see the relative enclosed sheet)



PTA 06-... & PTA 125-... FOR COLOURS OTHER THAN WHITE, PLEASE CONTACT US TO AGREE PRICES AND MINIMUM QUANTITY

PROTERMINAL

PROTERMINAL is a professional edging profile in impact-resistant non-toxic vinyl resin. It is used to complete the laying of outside corners when tiling, protecting the external edges against impact and chipping. **PROTERMINAL** may also be used as an edging trim for skirtings, carpeting, for epoxy resin coatings or for bathroom and kitchen wall coverings. (PVC).

PROTERMINAL

IMPACT-RESISTANT NON-TOXIC
COLOURED VINYL RESIN

NON-TOXIC IMPACT-RESISTANT COLOURED VINYL RESIN
bar length 2,7 LM - Pack. 54 LM (colour white Pack. 108 LM)

Article	H mm	€/LM	€/Pc
PT 06-...	6	0,92	2,48
PT 08-...	8	1,03	2,78
PT 10-...	10	1,13	3,05
PT 125-...	12,5	1,34	3,62

Available in the colours: 01-02-03-04-05-06-07-08-09-10-11-12-13-14-15-16-17-18-0106 (19-20-21-22-23-24-25-26-27-28-29 available upon request with a minimum quantity order of 5400 LM). The code of the selected colour must be added to the article code. E.g.: PT 06-... (chosen colour White) PT 06-01.

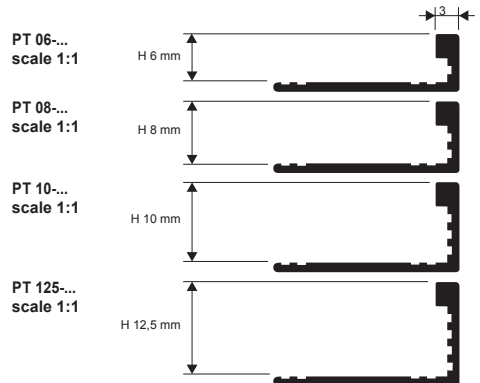

WHITE NOT FOR SALE SINGLY

COLOURS (for a precise assessment of colours and finishes, see the relative enclosed sheet)

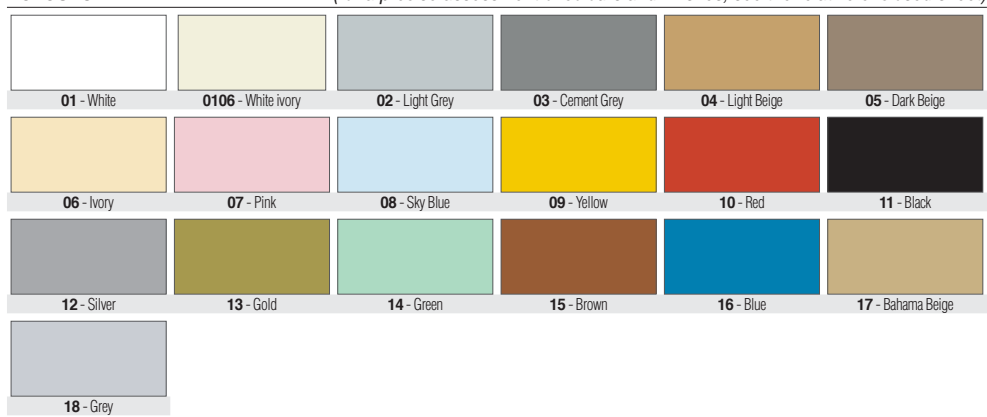

AVAILABLE UPON REQUEST. Minimum quantity 5400 LM per colour and height (price and delivery time to be agreed).



PROLISTEL ACC

POLISHED AND SATINED STAINLESS STEEL AISI 304/1.4301-V2A SQUARES AND LEATHER EFFECT

PROLISTEL ACC is a range of decorative profiles/strips that are ideal for easily creating chromatic effects on ceramic tile/marble/mosaic coverings or, in the stainless steel AISI 304/1.4301-V2A range, for creating separations and decorations between floors in the same or differing material. Thanks to their design, shape and thickness of 4,5 and 10 mm, may be laid using the same adhesive to create horizontal and vertical lines, on the wall or on the floor, irrespective of the thickness of the covering. Various finishes and widths available in stainless steel AISI 04/1.4301-V2A, polished and satin. Match with the same basic colours in the **PROJOLLY**, **PROTERMINAL** and **PROJOLLY SQUARE** and the new **PROKERLAM SQUARE-LINE-JOLLY** range.

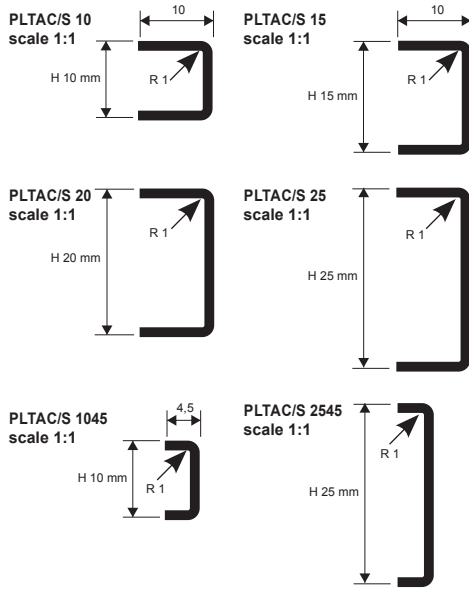

EXAMPLES AND INSTRUCTIONS FOR LAYING METHODS

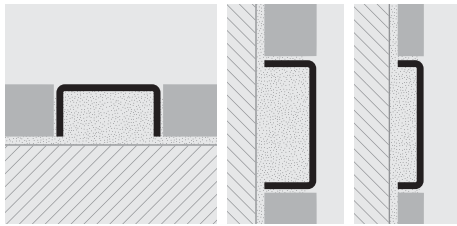

EXAMPLES AND INSTRUCTIONS FOR LAYING METHODS

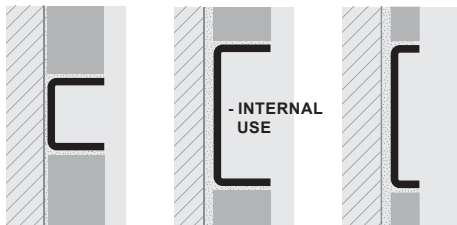

1. Choose the PROLISTEL in the required width. 2. Apply the adhesive onto the area of application of the profile. 3. Lay and align the profile, cut to the necessary length, pressing it into the adhesive. 4. Lay the tiles, aligning them so that the top edge of the profile is flush with the tile. 5. Fill the profile/tile area of contact with adhesive to prevent the accumulation of water in any voids. Pay attention to the external edges of the PROLISTEL. They must be protected against agents such as adhesives and sealants and against grinding or scraping actions.

COLOURS

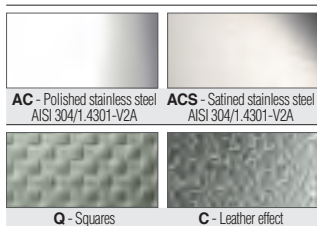

(for a precise assessment of colours and finishes, see the relative enclosed sheet)

POLISHED STAINLESS STEEL AISI 304/1.4301-V2A with protective film
bar length 2,7 LM - packaging 40 Pcs - 108 LM - 8/10mm

Article	HxW mm	€/LM	€/Pc
PLTAC 10	10 x 10	5,81	15,69
PLTAC 1045	10 x 4,5	5,55	14,99
PLTAC 15	15 x 10	7,73	20,87
PLTAC 20	20 x 10	10,31	27,84
PLTAC 25	25 x 10	12,89	34,80
PLTAC 2545	25 x 4,5	12,63	34,10

SATINED STAINLESS STEEL AISI 304/1.4301-V2A with protective film
bar length 2,7 LM - packaging 40 Pcs - 108 LM - 8/10mm

Article	HxW mm	€/LM	€/Pc
PLTACS 10	10 x 10	6,96	18,79
PLTACS 1045	10 x 4,5	7,09	19,14
PLTACS 15	15 x 10	10,05	27,14
PLTACS 20	20 x 10	13,39	36,15
PLTACS 25	25 x 10	14,84	40,07
PLTACS 2545	25 x 4,5	14,58	39,37

POLISHED STAINLESS STEEL AISI 304/1.4301-V2A SQUARES
with protective film - bar length 2,7 LM - packaging 40 Pcs - 108 LM - 8/10mm

Article	HxW mm	€/LM	€/Pc
PLTACQ 10	10 x 10	18,00	48,60
PLTACQ 25	25 x 10	20,50	55,38

POLISHED STAINLESS STEEL AISI 304/1.4301-V2A LEATHER EFFECT
with protective film - bar length 2,7 LM - packaging 40 Pcs - 108 LM - 8/10mm

Article	HxW mm	€/LM	€/Pc
PLTACC 10	10 x 10	18,00	48,60
PLTACC 25	25 x 10	20,50	55,38

POLISHED STAINLESS STEEL AISI 304/1.4301-V2A - INTERNAL USE
with protective film - bar length 2,7 LM - packaging 40 Pcs - 108 LM - 8/10mm

Article	HxW mm	€/LM	€/Pc
PLTACI 10	10 x 10	5,81	15,69
PLTACI 1045	10 x 4,5	5,55	14,99
PLTACI 15	15 x 10	7,73	20,87
PLTACI 20	20 x 10	10,31	27,84
PLTACI 25	25 x 10	12,89	34,80
PLTACI 2545	25 x 4,5	12,63	34,10

SATINED STAINLESS STEEL AISI 304/1.4301-V2A - INTERNAL USE - with protective film - bar length 2,7 LM - packaging 40 Pcs - 108 LM - 8/10mm

Article	HxW mm	€/LM	€/Pc
PLTACSI 10	10 x 10	6,96	18,79
PLTACSI 1045	10 x 4,5	7,09	19,14
PLTACSI 15	15 x 10	10,05	27,14
PLTACSI 20	20 x 10	13,39	36,15
PLTACSI 25	25 x 10	14,84	40,07
PLTACSI 2545	25 x 4,5	14,58	39,37

PRODUCTION ON DEMAND

PRODUCTION ON DEMAND

SUITABLE FOR USE IN CONTACT WITH FOODSTUFFS.

News 2015 available from February

PROLISTEL ACC is a range of decorative profiles/strips that are ideal for easily creating chromatic effects on ceramic tile/marble/mosaic coverings or, in the stainless steel AISI 316L/1.4404-V4A range, for creating separations and decorations between floors in the same or differing material. Thanks to their design, shape and thickness of 4.5 and 10 mm, may be laid using the same adhesive to create horizontal and vertical lines, on the wall or on the floor, irrespective of the thickness of the covering. Various finishes and widths available in stainless steel AISI 304/1.4301-V2A, polished and satin. Match with the same basic colours in the **PROJOLLY**, **PROTERMINAL** and **PROJOLLY SQUARE** and the new **PROKERLAM SQUARE-LINE-JOLLY** range.

PROLISTEL ACC

POLISHED STAINLESS STEEL
AISI 316L/1.4404-V4A

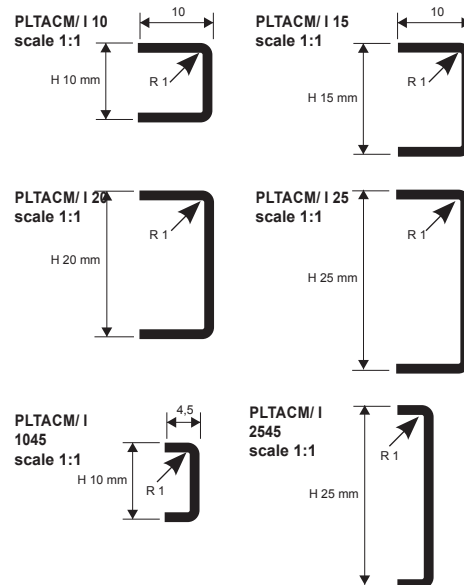

POLISHED STAINLESS STEEL AISI 316L/1.4404-V4A with protective film
bar length 2,7 LM - packaging 40 Pcs - 108 LM - 8/10mm

Article	HxL mm	€/LM	€/Pc
PLTACM 10	10 x 10	7,55	20,38
PLTACM 1045	10 x 4,5	7,21	19,46
PLTACM 15	15 x 10	10,05	27,13
PLTACM 20	20 x 10	13,40	36,18
PLTACM 25	25 x 10	16,76	45,25
PLTACM 2545	25 x 4,5	16,42	44,33

POLISHED STAINLESS STEEL AISI 316L/1.4404-V4A - INTERNAL USE - with protective film - bar length 2,7 LM - packaging 40 Pcs - 108 LM - 8/10mm

Article	HxL mm	€/LM	€/Pc
PLTACMI 10	10 x 10	7,55	20,38
PLTACMI 1045	10 x 4,5	7,21	19,46
PLTACMI 15	15 x 10	10,05	27,13
PLTACMI 20	20 x 10	13,40	36,18
PLTACMI 25	25 x 10	16,76	45,25
PLTACMI 2545	25 x 4,5	16,42	44,33

**PRODUCTION ON REQUEST. DELIVERY TIME TO BE AGREED.
SUITABLE FOR USE IN CONTACT WITH FOODSTUFFS.**

EXAMPLES AND INSTRUCTIONS FOR LAYING METHODS

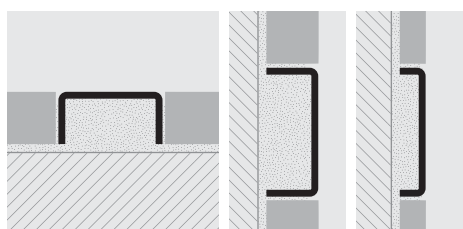

EXAMPLES AND INSTRUCTIONS FOR LAYING METHODS

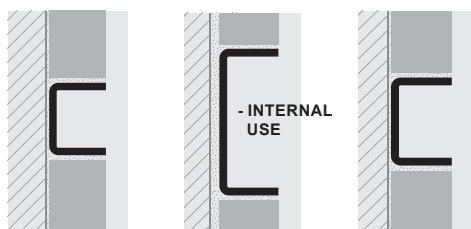

1. Choose the PROLISTEL in the required width. 2. Apply the adhesive onto the area of application of the profile. 3. Lay and align the profile, cut to the necessary length, pressing it into the adhesive. 4. Lay the tiles, aligning them so that the top edge of the profile is flush with the tile. 5. Fill the profile/tile area of contact with adhesive to prevent the accumulation of water in any voids. Pay attention to the external edges of the PROLISTEL. They must be protected against agents such as adhesives and sealants and against grinding or scraping actions.

COLOURS



ACM - Edelstahl AISI 316L/
1.4404 glänzend

(for a precise assessment of colours and finishes, see the relative enclosed sheet)



PROLISTEL P ALL

ANODISED, POLISHED, POLISHED BRUSHED
AND BRUSHED TILTEX ALUMINIUM

PROLISTEL P ALL is a decorative strip that adds colour effects to ceramic-tiled walls. Its angular design makes it suitable for walls tiled with rectified porcelain stoneware. It can also be used to separate two floors made of the same and/or different materials. The strip is applied with the same adhesive used for ceramic or wood. Available in various finishes: glossy (Polished), brushed (Polished Brushed), Anodised and new TILTEX brushed finish. Best results when matched with the same colour schemes of **PROJOLLY**, **PROTERMINAL**, **PROBORD** and **PROJOLLYSQUARE**.

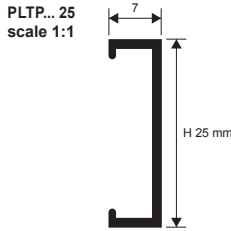
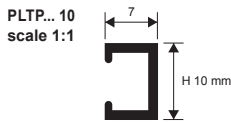

EXAMPLES AND INSTRUCTIONS FOR LAYING METHODS

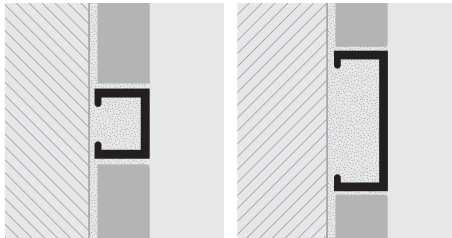

1. Choose the preferred finish. 2. Spread the adhesive on the place of application. 3. Apply and align the profile, after cutting to length. 4. Lay the tiles/ceramic or spread the resin, aligning the profile so that the top is flush.
IMPORTANT: Pay attention to the external edges of the aluminium prolistel. They must be protected against agents such as adhesives and sealants and against grinding or scraping actions.



ANODISED ALUMINIUM (silver-copper-titanium and black)
thermo packed - bar length 2,7 LM - packaging 40 Pcs - 108 LM

Article	H mm	€/LM	€/Pcs
PLTPAA 10 (anod. silver)	10	3,90	10,53
PLTPAR 10 (anod. copper)	10	5,39	14,55
PLTPAT 10 (anod. titanium)	10	5,39	14,55
PLTPNE 10 (anod. black)	10	5,46	14,74
PLTPAA 25 (anod. silver)	25	6,26	16,90
PLTPAR 25 (anod. copper)	25	8,32	22,46
PLTPAT 25 (anod. titanium)	25	7,29	19,68
PLTPNE 25 (anod. black)	25	8,50	22,95

POLISHED ALUMINIUM (chrome-titanium-copper and black)
thermo packed - bar length 2,7 LM - packaging 40 Pcs - 108 LM

Article	H mm	€/LM	€/Pcs
PLTPBC 10 (polished chrome)	10	5,60	15,12
PLTPBR 10 (polished copper)	10	7,24	19,55
PLTPBT 10 (polished titanium)	10	7,24	19,55
PLTPBN 10 (polished black)	10	7,33	19,79
PLTPBC 25 (polished chrome)	25	8,11	21,90
PLTPBR 25 (polished copper)	25	9,14	24,68
PLTPBT 25 (polished titanium)	25	8,11	21,90
PLTPBN 25 (polished black)	25	9,35	25,25

ALUMINIUM TUSCANY LINE/ CREPE' thermo packed
bar length 2,7 LM - packaging 40 Pcs - 108 LM

Article	H mm	€/LM	€/Pcs
PLTPA 10-05TU (beige)	10	9,33	25,19
PLTPA 10-20TU (bronze)	10	9,33	25,19
PLTPA 10-03TU (grey)	10	9,33	25,19
PLTPA 10-CR (crepé black)	10	9,33	25,19
PLTPA 25-05TU (beige)	25	12,00	32,40
PLTPA 25-20TU (bronze)	25	12,00	32,40
PLTPA 25-03TU (grey)	25	12,00	32,40
PLTPA 25-CR (crepé black)	25	12,00	32,40

POLISHED BRUSHED ALUMINIUM (silver-copper-titanium and black)
thermo packed - bar length 2,7 LM - packaging 40 Pcs - 108 LM

Article	H mm	€/LM	€/Pcs
PLTPBS 10 (brush. silver)	10	5,65	15,26
PLTPRS 10 (brush. copper)	10	7,50	20,25
PLTPTS 10 (brush. titanium)	10	7,50	20,25
PLTPNS 10 (brush. black)	10	7,59	20,49
PLTPBS 25 (brush. silver)	25	8,11	21,90
PLTPRS 25 (brush. copper)	25	9,86	26,62
PLTPTS 25 (brush. titanium)	25	9,86	26,62
PLTPNS 25 (brush. black)	25	10,07	27,19

BRUSHED ALU. TILTEX (silver-copper-titanium and black)
thermo packed - bar length 2,7 LM - packaging 40 Pcs - 108 LM

Article	H mm	€/LM	€/Pcs
PLTPBX 10 (silver) TILTEX	10	8,73	23,57
PLTPRX 10 (copper) TILTEX	10	8,73	23,57
PLTPTX 10 (titanium) TILTEX	10	8,73	23,57
PLTPBX 25 (silver) TILTEX	25	11,50	31,05
PLTPRX 25 (copper) TILTEX	25	11,50	31,05
PLTPTX 25 (titanium) TILTEX	25	11,50	31,05

COLOURS



(for a precise assessment of colours and finishes, see the relative enclosed sheet)

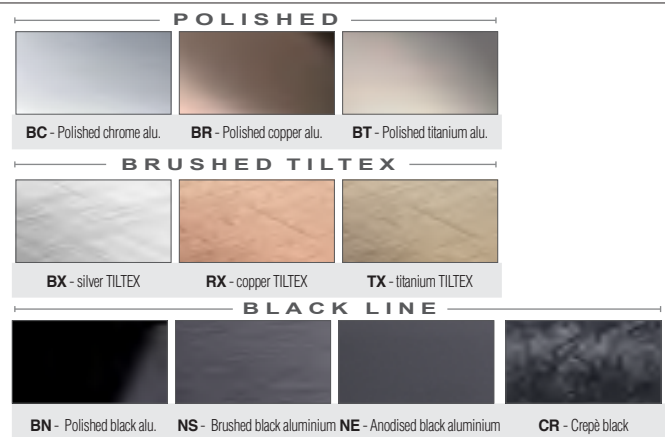

PROLISTEL ALL are a range of decorative profiles/strips that are ideal for creating instant chromatic effects on ceramic tile/marble/mosaic coverings. Thanks to their design, shape and thickness, **PROLISTEL ALL** may be laid using the same adhesive as the tiles or parquet to create horizontal and vertical lines on either the wall or floor irrespective of the thickness of the covering. Various finishes and widths available in Anodised, polished and brushed aluminium. Match with the same basic colours in the **PROJOLLY**, **PROTERMINAL**, **PROBORD** and **PROJOLLYSQUARE** ranges.

PROLISTEL ALL

ANODISED, POLISHED, VARNISHED & BRUSHED ALUMINIUM

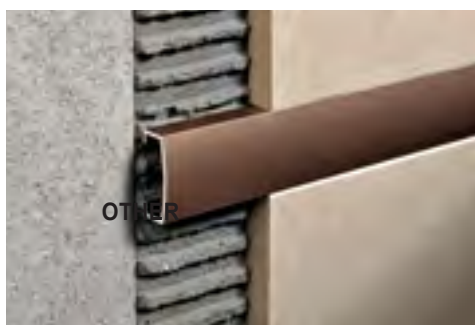

POLISHED ALUMINIUM (chrome-titanium-copper-black)
thermo packed - bar length 2,7 LM - packaging 40 Pcs - 108 LM

Article	H mm	€/LM	€/Pcs
PLTBC 15 (polished chrome)	15	5,65	15,26
PLTBR 15 (polished copper)	15	6,98	18,85
PLTBT 15 (polished titanium)	15	6,98	18,85
PLTBN 15 (polished black)	15	7,06	19,06
PLTBC 25 (polished chrome)	25	7,70	20,79
PLTBR 25 (polished copper)	25	9,04	24,41
PLTBT 25 (polished titanium)	25	9,04	24,41
PLTBN 25 (polished black)	25	9,15	24,71

OTHER COLOURS AVAILABLE UPON REQUEST (SEE OUR COLOUR CHART). PLEASE CONTACT US TO KNOW MINIMUM QUANTITY, DELIVERY TIME AND PRICE.

ANODISED ALUMINIUM (silver-copper-titanium-black)
thermo packed - bar length 2,7 LM - packaging 40 Pcs - 108 LM

Article	H mm	€/LM	€/Pcs
PLTAA 15 (anod. silver)	15	4,61	12,45
PLTAR 15 (anod. copper)	15	5,64	15,23
PLTAT 15 (anod. titanium)	15	5,64	15,23
PLTNE 15 (anod. black)	15	5,71	15,42
PLTAA 25 (anod. silver)	25	5,75	15,53
PLTAR 25 (anod. copper)	25	7,34	19,82
PLTAT 25 (anod. titanium)	25	7,34	19,82
PLTNE 25 (anod. black)	25	7,44	20,09

POLISHED BRUSHED ALUMINIUM (silver-copper-titanium-black)
thermo packed - bar length 2,7 LM - packaging 40 Pcs - 108 LM

Article	H mm	€/LM	€/Pcs
PLTBS 15 (brush. silver)	15	7,39	19,95
PLTRS 15 (brush. copper)	15	9,04	24,41
PLTTS 15 (brush. titanium)	15	9,04	24,41
PLTNS 15 (noir brossé)	15	9,15	24,71
PLTBS 25 (brush. silver)	25	8,16	22,03
PLTRS 25 (brush. copper)	25	9,71	26,22
PLTTS 25 (brush. titanium)	25	9,71	26,22
PLTNS 25 (noir brossé)	25	9,82	26,51

COLOURS

(for a precise assessment of colours and finishes, see the relative enclosed sheet)



COLOURS

(for a precise assessment of colours and finishes, see the relative enclosed sheet)



PROLISTEL LED is an innovative profile in aluminium SILVER ANODISED and aluminium polished chrome, with 20mm height and 8mm width, equipped with an integrated LED lighting system, generating cold or warm light, conceived for the illumination of tiled walls of kitchens and bathrooms. The aluminium structure of **PROLISTEL LED** is provided with a lateral dovetail slot for the anchorage to the adhesive and with a special fixing system that allows to remove the matt or transparent polycarbonate plate any time maintenance on the lighting system should be required. Its particular design, together with the finishes available and the easy installation make **PROLISTEL LED** a very requested profile for the decoration of any kind of covering.

PROLISTEL LED

ANODISED ALUMINIUM POLISHED ALUMINIUM



SILVER ANODISED, POLISHED CHROME ALUMINIUM
thermo packed - bar length 2,7 LM - Pack. 40 Pcs - 108 LM
ADAPTOR LED & POLYCARBONATE'S FLAT NOT INCLUDED

Article	H mm	€/LM	€/Pc
PLTLEDAA 20 (silver anod.)	20	9,50	25,65
PLTLEDBC 20 (polish. chrome)	20	10,75	29,03

ADHESIVE FLEXIBLE LED COIL

length 5 LM - Pack. 1 Roll

Article	€/LM	€/Pc
LEDN (neutral light)	17,20	86,00
LEDF (cold light)	17,20	86,00
LEDC (hot light)	17,20	86,00

COLOURS



(for a precise assessment of colours and finishes, see the relative enclosed sheet)



POLYCARBONATE'S FLAT
bar length 2,7 ML - Pack. 20 Pcs - 54 LM

Article	Finish	€/LM	€/Pc
PIAL 17	transp.	3,95	10,67
PIAO 17	matt	3,95	10,67

ENDCAPS- R/L (3 R & 3 L)

Article	H mm	€/Pc	€/Pack
TPLTLEDAA 20	20	2,80	16,80
TPLTLEDBC 20	20	2,80	16,80

LED ADAPTOR AC/DC 75W - 12V (15 LM)

Article	€/Pc
ALL 7512 (supplies 15 LM)	63,00

LED ADAPTOR AC/DC 25W - 12V (5 LM)

Article	€/Pc
ALL 2512 (supplies 5 LM)	43,20

PLTLED...
Scale 1:1

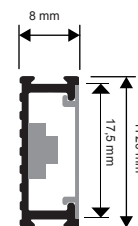

EXAMPLES AND INSTRUCTIONS FOR LAYING METHODS



1. Choose Prolistel LED in the desired finish; 2. Cut Prolistel LED to the desired length and apply the adhesive on the area where the profile will be installed; 3. Press the profile into the adhesive, aligning the profile edge with the surface of the tiles; 4. Lay the tiles, leaving a 2mm joint. Remove immediately the remains of adhesive from the profile surface; 5. Fill the joints between the profile and the tiles with sealant, in order to avoid water stagnation. Remove immediately the remains of sealant from the profile surface; 6. Insert the LED lights and connect them to the power supply; 7. Install the removable polycarbonate plate.

PROFINLIST 20

ANODISED, POLISHED, POLISHED BRUSHED
AND BRUSHED TILTEX ALUMINIUM

PROFINLIST 20 is a decorative strip that adds colour effects to Kerlite/ Laminam, porcelain stoneware and ceramic tiled walls. It is designed with the perforated base to be laid "under covering" and with the living angles to be combined with rectified coverings. It can also be used to separate floors of the same and/or different kind or to finish the steps. It is applied with the same adhesive for ceramic tiles and/or mosaic.

Available in various finishes: Anodised (silver-copper-titanium), Polished (chrome-copper-titanium-gold), brushed (silver-copper-titanium) and new TILTEX brushed finish. Combining with the same chromatic base **PROJOLLY**, **PROTERMINAL**, **PROBORD** and **PROJOLLY SQUARE** and the new **PROKERLAM** and **PROJOLLY SQUARE** range is recommended.

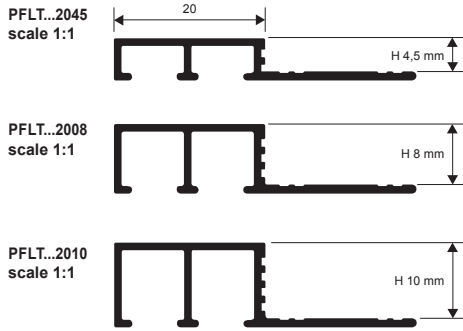

EXAMPLES AND INSTRUCTIONS FOR LAYING METHODS

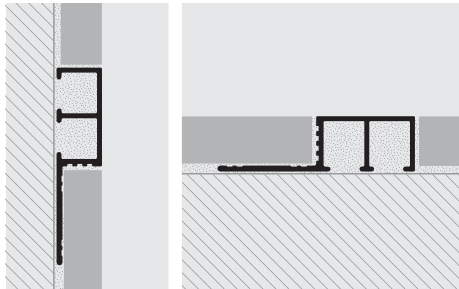

1. Choose the PROFINLIST 20 surface finish whose height corresponds to covering thickness. 2. Apply the adhesive in the area that the square is being applied. 3. Rest and line up the square, cut to the required length, pressing the perforated tab into the adhesive. 4. Lay the tiles/ ceramic tiles or apply the resin, lining it up so that the upper part of the square meets with their edge.

IMPORTANT: Pay attention to the external edges of the aluminium profinlist 20. They must be protected against agents such as adhesives and sealants and against grinding or scraping actions.



ANODISED ALUMINIUM thermo packed bar length 2,7 LM - packaging 40 Pcs - 108 LM

Article	H mm	€/LM	€/Pcs
PFLTAA 2045	4,5	6,21	16,77
PFLTAA 2008	8	6,26	16,90
PFLTAR 2008	8	7,45	20,12
PFLTAT 2008	8	7,45	20,12
PFLTAA 2010	10	6,42	17,33
PFLTAR 2010	10	7,65	20,66
PFLTAT 2010	10	7,65	20,66

POLISHED ALUMINIUM thermo packed bar length 2,7 LM - packaging 40 Pcs - 108 LM

Article	H mm	€/LM	€/Pcs
PFLTBC 2045	4,5	7,24	19,55
PFLTBO 2045	4,5	7,24	19,55
PFLTBC 2008	8	7,70	20,79
PFLTBR 2008	8	8,99	24,27
PFLTBT 2008	8	7,70	20,79
PFLTBC 2010	10	7,86	21,22
PFLTBR 2010	10	9,19	24,81
PFLTBT 2010	10	7,86	21,22

BRUSHED ALUMINIUM thermo packed bar length 2,7 LM - packaging 40 Pcs - 108 LM

Article	H mm	€/LM	€/Pcs
PFLTBS 2045	4,5	8,63	23,30
PFLTBS 2008	8	8,99	24,27
PFLTRS 2008	8	11,04	29,81
PFLTTS 2008	8	11,04	29,81
PFLTBS 2010	10	9,19	24,81
PFLTRS 2010	10	11,25	30,38
PFLTTS 2010	10	11,25	30,38

BRUSHED ALUMINIUM TILTEX thermo packed bar length 2,7 LM - packaging 40 Pcs - 108 LM

Article	H mm	€/LM	€/Pcs
PFLT BX 2008	8	9,91	26,76
PFLTRX 2008	8	12,12	32,72
PFLT TX 2008	8	12,12	32,72
PFLT BX 2010	10	10,06	27,16
PFLTRX 2010	10	12,38	33,43
PFLT TX 2010	10	12,38	33,43



COLOURS

(for a precise assessment of colours and finishes, see the relative enclosed sheet)



PROBORD is a rounded angle corner guard in stainless steel AISI 304-1.4301 used to protect and cover the outside corners and edges of tiled walls. It is applied while laying the tiles, thereby ensuring a precise flush finish with the covering. Extremely attractive, it is recommended for premises open to the public, schools, hospitals, kitchens and food industries. It is in conformity with accident-prevention and health and hygiene directives. Can be matched with **PROLISTEL** and **PROSHELL** AISI 304-1.4301 stainless steel profiles with polished or satin finish.
Available in 3 widths 8, 10, 12.5 mm.

PROBORD

POLISHED AND SATINED
STAINLESS STEEL AISI 304/1.4301-V2A



POLISHED STAINLESS STEEL AISI 304/1.4301-V2A with protective film
bar length 2,7 LM - packaging 15 Pcs - 40,5 LM - 10/10mm

Article	H mm	€/LM	€/Pcs
PEBDAC 08	08	15,92	42,98
PEBDAC 10	10	16,53	44,63
PEBDAC 125	12,5	16,95	45,77

SATINED STAINLESS STEEL AISI 304/1.4301-V2A with protective film
bar length 2,7 LM - packaging 15 Pcs - 40,5 LM - 10/10mm

Article	H mm	€/LM	€/Pcs
PEBDACS 08	08	18,64	50,33
PEBDACS 10	10	19,15	51,71
PEBDACS 125	12,5	19,77	53,38

COLOURS

(for a precise assessment of colours and finishes, see the relative enclosed sheet)



SUITABLE FOR USE IN CONTACT WITH FOODSTUFFS.

EXAMPLES AND INSTRUCTIONS FOR LAYING METHODS

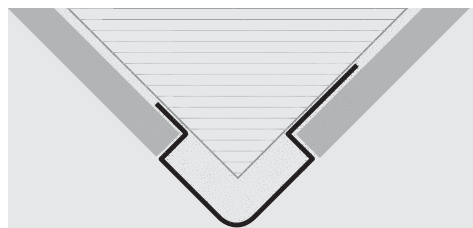

1. Choose the PROBORD with suitable width for the thickness of the covering.
2. Apply the adhesive onto the area of application of the profile.
3. Lay and align the profile, cut to the necessary length, pressing the perforated flange into the adhesive.
4. Lay the tiles, aligning them so that the top edge of the profile is flush with the tile.
5. Fill the profile/tile area of contact with adhesive to prevent the accumulation of water in any voids.

PEBDAC/ACS 08

scale 1:1

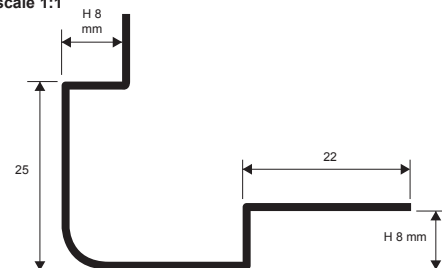

PEBDAC/ACS 10

scale 1:1

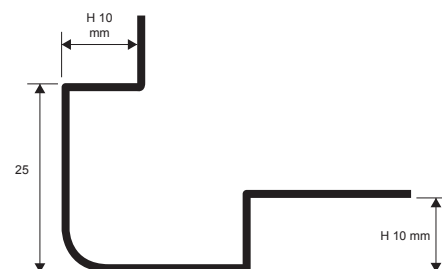

PEBDAC/ACS 125

scale 1:1

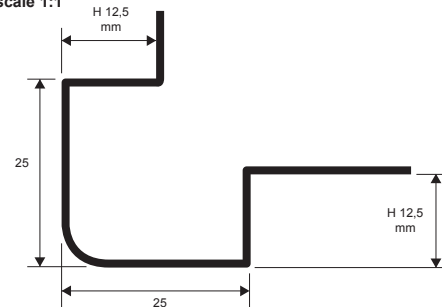

PROEDGE FLEX

IMPACT-RESISTANT NON-TOXIC
CO-EXTRUDED COLOURED VINYLE RESIN

PROEDGE FLEX is a patented co-extruded corner guard profile in impact-resistant non-toxic rigid PVC and strong flexible PVC. Recommended for safety protection in various environments such as schools, hospitals, kindergartens and premises open to the public. The profile has been carefully designed with a groove in the rigid part that facilitates application of the self-adhesive backing or silicone to create perfect adhesion and without gaps, which would encourage the accumulation of dust and dirt. Innovative, impact-resistant and highly attractive product. Available with or without self-adhesive backing in 2.7 m bars.



CO-EXTRUDED PVC - L 40 X 40MM

bar length 2,7 LM - packaging 20 Pcs - 54 LM

Article	H mm	€/LM	€/Pcs
PFC... 40 (without adhesive)	40	6,37	17,20
PFC... 40A (with adhesive)	40	8,52	23,00

COLOURS

(for a precise assessment of colours and finishes, see the relative enclosed sheet)

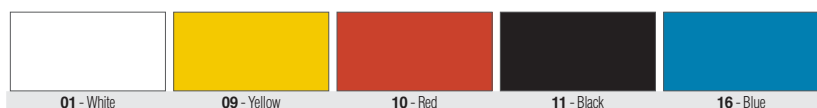

PFC... 40/40A

scale 1:2

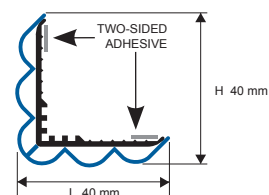

EXAMPLES AND INSTRUCTIONS FOR LAYING METHODS

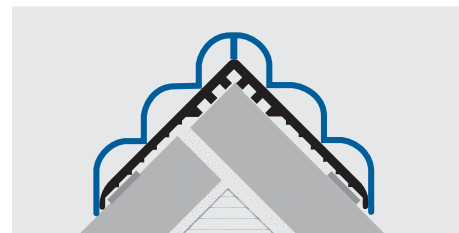

1. Choose the suitable colour for covering the edge of the wall covering/wall.
2. Clean the surface on which the profile is to be laid, ensuring that it is grease-free and dry. Application is recommended at a temperature of at least 15° (when using the profile with self-adhesive backing).
3. Remove the protective paper from the adhesive and lay correctly by applying pressure evenly over the whole profile without using a hammer.

PROEDGE AC

POLISHED AND SATINED STAINLESS STEEL AISI 304/1.4301-V2A

PROEDGE AC consists of a vast range of corner guard profiles used to protect and cover the most exposed part of any type of wall covering and existing edges. **PROEDGE AC** is made in polished stainless steel in four different widths to meet all technical and aesthetic requirements. Available with self-adhesive backing. Its high impact-absorption properties ensure that it complies with compulsory EUROPEAN standards for covering chipped or hazardous edges. It is mainly used in the industrial, food and commercial sectors and where traffic is intense.

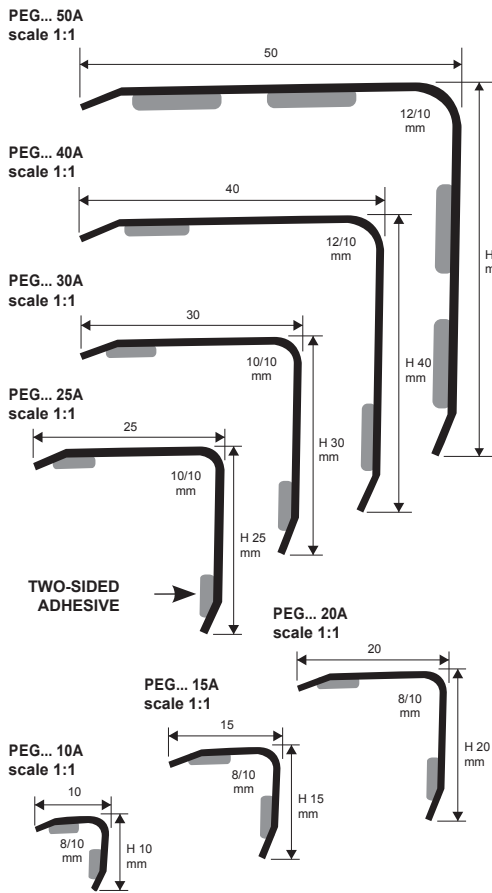

POLISHED AND SATINED STAINLESS STEEL WITH ADHESIVE with protective film - bar length 2,7 LM - Pack. 81 LM - 8/10 mm

Article	LxH mm	€/LM	€/Pcs
PEGAC 10A (polished stainless)	10 x 10	6,68	18,04
PEGACS 10A (satined stainless)	10 x 10	8,16	22,03
PEGAC 15A (polished stainless)	15 x 15	7,70	20,79
PEGACS 15A (satined stainless)	15 x 15	9,19	24,81
PEGAC 20A (polished stainless)	20 x 20	8,73	23,57
PEGACS 20A (satined stainless)	20 x 20	10,22	27,59

POLISHED AND SATINED STAINLESS STEEL WITH ADHESIVE with protective film - bar length 2,7 LM - Pack. 27 LM - 12/10 mm

Article	LxH mm	€/LM	€/Pcs
PEGAC 40A (polished stainless)	40 x 40	17,56	47,41
PEGACS 40A (satined stainless)	40 x 40	19,89	53,70
PEGAC 50A (polished stainless)	50 x 50	20,43	55,16
PEGACS 50A (satined stainless)	50 x 50	22,08	59,62

For items without adhesive, deduct 0,70€ from the net price for LM, and write the item without the final A. E.g.: PEGAC 40.

POLISHED AND SATINED STAINLESS STEEL WITH ADHESIVE with protective film - bar length 2,7 LM - Pack. 40,5 LM - 10/10 mm

Article	LxH mm	€/LM	€/Pcs
PEGAC 25A (polished stainless)	25 x 25	9,76	26,35
PEGACS 25A (satined stainless)	25 x 25	11,29	30,48
PEGAC 30A (polished stainless)	30 x 30	13,86	37,42
PEGACS 30A (satined stainless)	30 x 30	15,68	42,34

For items without adhesive, deduct 0,70€ from the net price for LM, and write the item without the final A. E.g.: PEGAC 10.

COLOURS



(for a precise assessment of colours and finishes, see the relative enclosed sheet)

PROEDGE OT

CHROMED AND POLISHED BRASS

PROEDGE OT consists of a vast range of corner guard profiles used to protect and cover the most exposed part of any type of wall covering and existing edges. **PROEDGE OT** is made in Chromed and polished brass in different widths to meet all technical and aesthetic requirements. Available with self-adhesive backing. Its high impact-absorption properties ensure that it complies with compulsory EUROPEAN standards for covering chipped or hazardous edges. It is mainly used in the industrial, food and commercial sectors and where traffic is intense.

EXAMPLES AND INSTRUCTIONS FOR LAYING METHODS

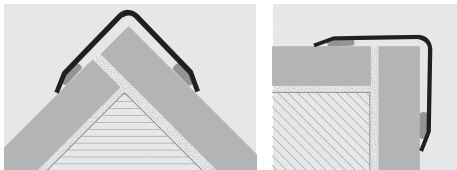

1. Choose the necessary profile for covering the edge of the covering/wall.
2. Clean the surface on which the profile is to be laid, ensuring that it is grease-free and dry. Application is recommended at a temperature of at least 15°.
3. Remove the protective film or thermo-packaging and then also the protective paper from the adhesive.
4. Lay correctly by applying pressure evenly over the whole profile without using a hammer.



CHROMED BRASS WITH ADHESIVE thermo packed - bar length 2,7 LM - Pack. 54 LM - 8/10 mm

Article	LxH mm	€/LM	€/Pcs
PEGOC 10A	10 x 10	11,81	31,89
PEGOC 15A	15 x 15	14,12	38,12
PEGOC 20A	20 x 20	17,41	47,01
PEGOC 25A	25 x 25	19,85	53,60
PEGOC 30A	30 x 30	23,15	62,51



POLISHED BRASS WITH ADHESIVE bar length 2,7 LM - Pack. 27 LM - 10/10 mm

Article	LxH mm	€/LM	€/Pcs
PEGOL 25A	25 x 25	12,84	34,67
PEGOL 30A	30 x 30	17,46	47,14



COLOURS



(for a precise assessment of colours and finishes, see the relative enclosed sheet)

POLISHED BRASS WITH ADHESIVE bar length 2,7 LM - Pack. 54 LM - 8/10 mm

Article	LxH mm	€/LM	€/Pcs
PEGOL 10A	10 x 10	8,32	22,46
PEGOL 15A	15 x 15	9,50	25,65
PEGOL 20A	20 x 20	12,17	32,86



POLISHED BRASS WITH ADHESIVE bar length 2,7 LM - Pack. 27 LM - 12/10 mm

Article	LxH mm	€/LM	€/Pcs
PEGOL 40A	40 x 40	22,08	59,62
PEGOL 50A	50 x 50	28,24	76,25



For items without adhesive, deduct 0,70€ from the net price for LM, and write the item without the final A. E.g.: PEGOL 25.

For items without adhesive, deduct 0,70€ from the net price for LM, and write the item without the final A. E.g.: PEGOL 10.

* = Upon request

News 2015

PROEDGE AL consists of a vast range of corner guard profiles used to protect and cover the most exposed part of any type of wall covering and existing edges. **PROEDGE AL** is made in Anodised aluminium in the size 25x25 mm. Available with self-adhesive backing. Its high impact-absorption properties ensure that it complies with compulsory EUROPEAN standards for covering chipped or hazardous edges. It is mainly used in the industrial, food and commercial sectors and where traffic is intense.

PROEDGE AL

ANODISED ALUMINIUM



PEG... 25A
PEGA 25-01A
scale 1:1

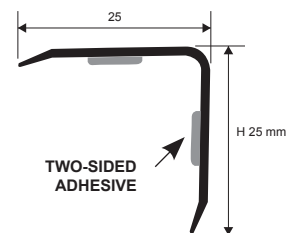

ANODISED ALUMINIUM (gold-silver and bronze) with **ADHESIVE thermo packed** - bar length 2,7 LM - Pack. 30 Pcs - 81 LM

Article	LxH mm	€/LM	€/Pcs
PEGAO 25A (Anod. gold)	25 x 25	5,44	14,69
PEGAA 25A (Anod. silver)	25 x 25	5,44	14,69
PEGAB 25A (Anod. bronze)	25 x 25	5,44	14,69

For items without adhesive, deduct 0,70€ from the net price for LM, and write the item without the final A. E.g.: PEGAO 25

WHITE VARNISHED ALUMINIUM with **ADHESIVE thermo packed** bar length 2,7 LM - Pack. 30 Pcs - 81 LM

Article	LxH mm	€/LM	€/Pcs
PEGA 25-01A (white varnished)	25 x 25	6,78	18,31

COLOURS



(for a precise assessment of colours and finishes, see the relative enclosed sheet)

EXAMPLES AND INSTRUCTIONS FOR LAYING METHODS



1. Choose the necessary profile for covering the edge of the covering/wall.
2. Clean the surface on which the profile is to be laid, ensuring that it is grease-free and dry. Application is recommended at a temperature of at least 15°.
3. Remove the protective film or thermo-packaging and then also the protective paper from the adhesive.
4. Lay correctly by applying pressure evenly over the whole profile without using a hammer.

© 2011 All rights reserved by Progress Profiles. Printed in Italy

PROEDGE PVC consists of a vast range of corner guard profiles used to protect and cover the most exposed part of any type of wall covering and existing edges. **PROEDGE PVC** is made in the sizes 25x25, 30x30, 40x40, 50x50 mm. Available with self-adhesive backing. Its high impact-absorption properties ensure that it complies with compulsory EUROPEAN standards for covering chipped or hazardous edges. It is mainly used in the industrial, food and commercial sectors and where traffic is intense.

PROEDGE PVC

IMPACT-RESISTANT NON-TOXIC COLOURED VINYL RESIN



IMPACT-RESISTANT VINYL RESIN WITH ADHESIVE bar length 2,7 LM - Pack. 30 Pcs - 81 LM

Article	LxH mm	€/LM	€/Pcs
PEG 25-01A	25 x 25	4,59	12,39
PEG 30-01A	30 x 30	5,20	14,04

For items without adhesive, deduct 0,70€ from the net price for LM, and write the item without the final A. E.g.: PEG 25-01

IMPACT-RESISTANT VINYL RESIN WITH ADHESIVE bar length 2,7 LM - Pack. 15 Pcs 40,5 LM

Article	LxH mm	€/LM	€/Pcs
PEG 40-01A	40 x 40	5,81	15,69
PEG 50-01A	50 x 50	6,43	17,36

For items without adhesive, deduct 0,70€ from the net price for LM, and write the item without the final A. E.g.: PEG 40-01

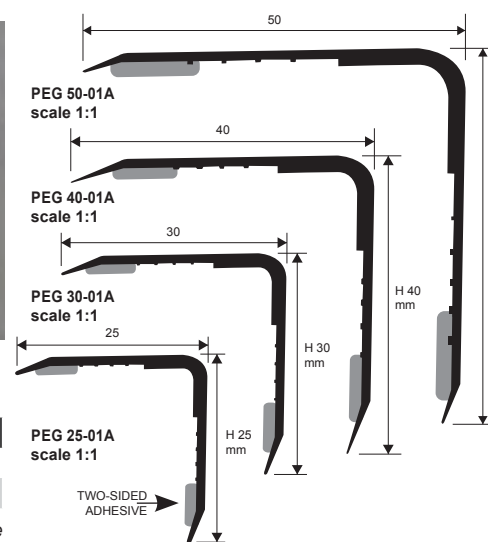

EXAMPLES AND INSTRUCTIONS FOR LAYING METHODS



1. Choose the necessary profile for covering the edge of the covering/wall.
2. Clean the surface on which the profile is to be laid, ensuring that it is grease-free and dry. Application is recommended at a temperature of at least 15°.
3. Remove the protective film or thermo-packaging and then also the protective paper from the adhesive.
4. Lay correctly by applying pressure evenly over the whole profile without using a hammer.

COLOURS

(for a precise assessment of colours and finishes, see the relative enclosed sheet)



Price to be calculated.

UPON REQUEST-MINIMUM QUANTITY 600 LM

PROSHELL

POLISHED AND SATINED STAINLESS STEEL AISI 304/1.4301-V2A

PROSHELL is a cove-shaped joint suitable for ensuring hygiene and easy cleaning in environments where foodstuffs and chemicals containing corrosive substances are used. Made in polished and satin-finish stainless steel, this product is used to create the inside corner between walls or between wall and floor. Compulsory for butchers' and kitchens; recommended for hospitals and special environments. The inside, outside and three-way corner linking elements facilitate faultless laying without gaps or joints.

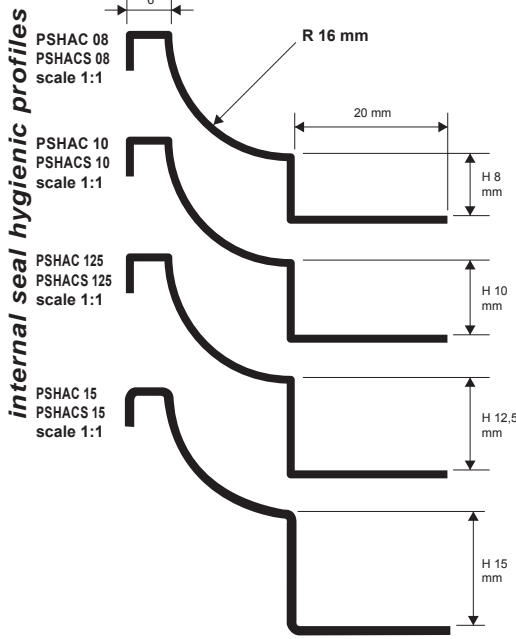

EXEMPLES OF LAYING

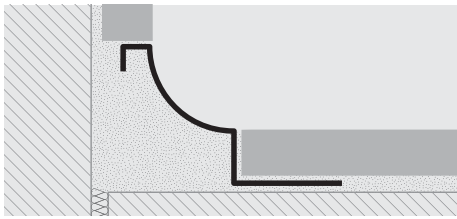

POLISHED STAINLESS STEEL AISI 304/1.4301-V2A with protective film
bar length 2,7 LM - packaging 20 Pcs - 54 LM

Article	H mm	€/LM	€/Pc
PSHAC 08	8	13,86	37,42
PSHAC 10	10	14,58	39,37
PSHAC 125	12,5	15,51	41,88
PSHAC 15	15	16,33	44,09



SATINED STAINLESS STEEL AISI 304/1.4301-V2A with protective film
bar length 2,7 LM - packaging 20 Pcs - 54 LM

Article	H mm	€/LM	€/Pc
PSHACS 08	8	15,41	41,61
PSHACS 10	10	16,18	43,69
PSHACS 125	12,5	16,53	44,63
PSHACS 15	15	17,56	47,41

LAYING INSTRUCTIONS

1. Choose the PROSHELL with suitable height for the thickness of the covering/floor. 2. Apply the adhesive onto the area of application of the profile. 3. Lay and align the profile, cut to the necessary length, pressing the perforated flange into the adhesive. 4. Lay the tiles, aligning them so that the top edge of the profile is flush with the tile and also joints, linking elements, etc. 5. Fill the profile/tile area of contact with adhesive to prevent the accumulation of water in any voids. 6. Before laying the floor/wall covering, fix the profiles/joints to ensure perfect results.

COLOURS



(for a precise assessment of colours and finishes, see the relative enclosed sheet)

SUITABLE FOR USE IN CONTACT WITH FOODSTUFFS

PREWELDED JOINTS, CAPS and JOINTS

POLISHED and SATINED STAINLESS STEEL

INSIDE JOINTS

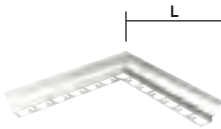

OUTSIDE JOINTS

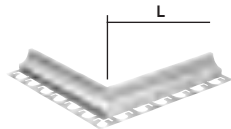

THREE WAY JOINTS



PREWELDED JOINTS - POLISHED STAINLESS STEEL

H 08 - H 10 - H 12,5 - H 15 mm - Pack. 10 Pcs

Article	Lmm	€/Pc	€/pack.
RPI 8-10-125 (inside)	100	16,74	167,40
RPI 15 (interno)	100	17,77	177,70
RPE 8-10-125 (outside)	100	16,74	167,40
RPE 15 (outside)	100	17,77	177,70
RPT 8-10-125 (three-way)	100	22,18	221,80
RPT 15 (three-way)	100	23,11	231,10

Specify height of joint: E.g.: RPI 8 for H 8 mm.

PREWELDED JOINTS - SATINED STAINLESS STEEL

H 08 - H 10 - H 12,5 - H 15 mm - Pack. 10 Pcs

Article	Lmm	€/Pc	€/pack.
RPIS 8-10-125 (inside)	100	17,97	179,70
RPIS 15 (inside)	100	18,90	189,00
RPES 8-10-125 (outside)	100	17,97	179,70
RPES 15 (outside)	100	18,90	189,00
RPTS 8-10-125 (three-way)	100	23,11	231,10
RPTS 15 (three-way)	100	24,44	244,40

Specify height of joint: E.g.: RPIS 8 for H 8 mm.

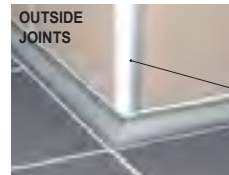

PROTERMINAL, PROJOLLY SQUARE and projolly quart (no projolly)



To facilitate and complete the application of **PROSHELL** (PSH..) (in AISI 304-1.4301 stainless steel), joints and right (DX) and left (SX) caps are available to close the profile ends and provide a connection with ceramic tiles, brickwork, wooden floors, etc. The caps are made of painted plastic with: in the bright stainless steel effect and satined stainless steel effect.

JOINT GISHN

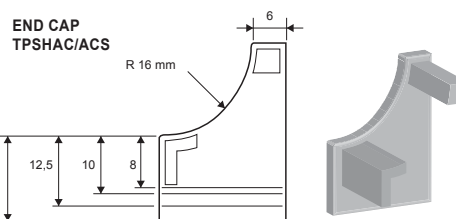
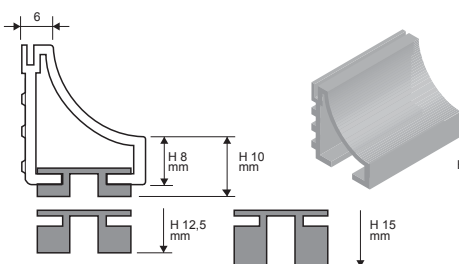

CAPS AND JOINTS in RIGID GREY PLASTIC

Pack. 10 Pcs

Article	€/Pc	€/pack.
TPSHAC caps R-L (poli. stainless steel effect)	3,59	35,90 (5 pairs)
TPSHACS caps R-L (satined stainless steel effect)	3,59	35,90 (5 pairs)
GISHN 08	3,08	30,80
GISHN 10	3,39	33,90
GISHN 125	3,70	37,00
GISHN 15	4,06	40,60



PROSHELL ALL

ANODISED, POLISHED ALUMINIUM
AND VARNISHED WHITE ALUMINIUM

PROSHELL ALL is a cove-shaped joint suitable for ensuring hygiene and easy cleaning in environments where foodstuffs are used. Made in SILVER ANODISED, polished and vaenished white aluminium, this product is used to create the inside corner between walls or between wall and floor. Compulsory for butchers' and kitchens; recommended for hospitals and special environments. The inside, outside and three-way corner linking elements facilitate faultless laying without gaps or joins.

PSHAA 8
scale 1:1

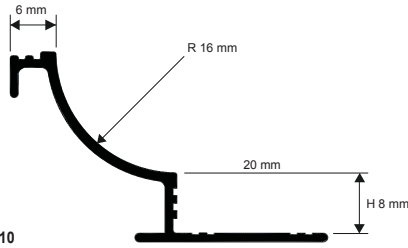

PSHAA 10
scale 1:1

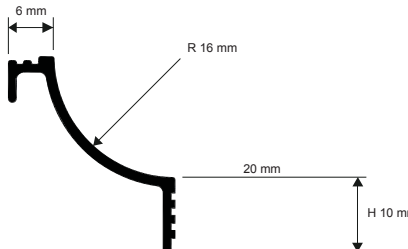

PSHAA 125
scale 1:1

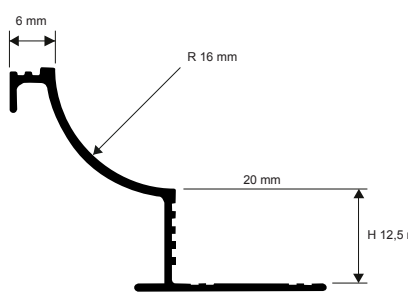

EXEMPLE DE POSE



ANODISED SILVER ALUMINIUM thermo packed
bar length 2,7 LM - packaging 20 Pcs - 54 LM

Article	H mm	€/LM	€/Pc
PSHAA 08	8	8,20	22,14
PSHAA 10	10	8,30	22,41
PSHAA 125	12,5	8,45	22,82

VARNISHED WHITE ALUMINIUM thermo packed
bar length 2,7 LM - packaging 20 Pcs - 54 LM

Article	H mm	€/LM	€/Pc
PSHA 08-01	8	9,70	26,19
PSHA 10-01	10	9,80	26,46
PSHA 125-01	12,5	11,41	30,81

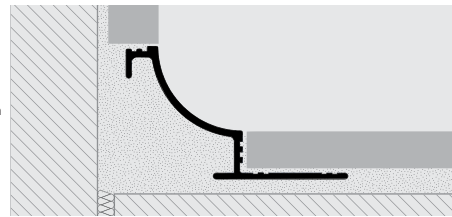

POLISHED CHROME ALUMINIUM thermo packed
bar length 2,7 LM - packaging 20 Pcs - 54 LM

Article	H mm	€/LM	€/Pc
PSHBC 08	8	11,40	30,78
PSHBC 10	10	11,60	31,32
PSHBC 125	12,5	11,85	31,99

COLOURS

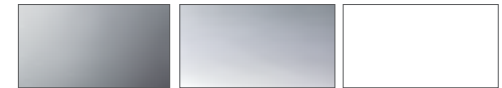

AA - Anod. Silver Aluminium BC - Polished chrome Alu. 01 - white varnished Alu.

(for a precise assessment of colours and finishes, see the relative enclosed sheet)

LAYING INSTRUCTIONS

1. Choose the PROSHELL ALL with suitable height for the thickness of the covering/floor. 2. Apply the adhesive onto the area of application of the profile. 3. Lay and align the profile, cut to the necessary length, pressing the perforated flange into the adhesive. 4. Lay the tiles, aligning them so that the top edge of the profile is flush with the tile and also joints, linking elements, etc. 5. Fill the profile/tile area of contact with adhesive to prevent the accumulation of water in any voids. Before laying the floor/wall covering, fix the profiles/joints to ensure perfect results.

END CAPS CORNERS & JOINTS/PLASTIC

SILVER ANODISED, POLISHED CHROME AND VARNISHED WHITE ALUMINIUM



JOINTS IN RIGID GREY PLASTIC - Pack. 10 Pcs

Article	H mm	€/Pc	\$/Pc
GISHN 08/...	8	3,08	30,80
GISHN 10/...	10	3,39	33,90
GISHN 125/...	12,5	3,70	37,00

TPSH... 08-10-125/...

GISHN... 08-10-125



Choose the desired packaging:
E.g. TPSH...-01/5 (pack 10 pcs)
TPSH...-01/1 (pack 2 pcs)

OUTSIDE/INSIDE CORNER - ANODISED SILVER ALUMINIUM - Pack. 10 Pcs - 2 Pcs

Article	H mm	€/Pc	€/10 Pcs	€/2 Pcs
RPSHIAA 08/...	8	14,40	144,00	31,68
RPSHEAA 08/...	8	14,40	144,00	31,68
RPSHIAA 10/...	10	14,40	144,00	31,68
RPSHEAA 10/...	10	14,40	144,00	31,68
RPSHIAA 125/...	12,5	14,40	144,00	31,68
RPSHEAA 125/...	12,5	14,40	144,00	31,68

OUTSIDE/INSIDE CORNER VARNISHED WHITE ALUMINIUM Pack. 10 Pcs - 2 Pcs

Article	H mm	€/Pc	€/10 Pcs	€/2 Pcs
RPSHIA 08-01/...	8	18,00	180,00	39,60
RPSHEA 08-01/...	8	18,00	180,00	39,60
RPSHIA 10-01/...	10	18,00	180,00	39,60
RPSHEA 10-01/...	10	18,00	180,00	39,60
RPSHIA 125-01/...	12,5	18,00	180,00	39,60
RPSHEA 125-01/...	12,5	18,00	180,00	39,60

RPSHI... 08-10-125

RPSHE... 08-10-125

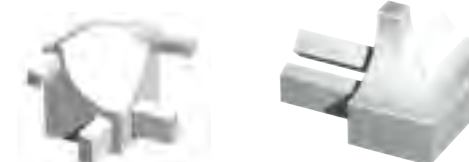

OUTSIDE/INSIDE CORNER POLISHED CHROME ALUMINIUM - Pack. 10 Pcs - 2 Pcs

Article	H mm	€/Pc	€/10 Pcs	€/2 Pcs
RPSHIBC 08/...	8	17,20	172,00	37,84
RPSHEBC 08/...	8	17,20	172,00	37,84
RPSHIBC 10/...	10	17,20	172,00	37,84
RPSHEBC 10/...	10	17,20	172,00	37,84
RPSHIBC 125/...	12,5	17,20	172,00	37,84
RPSHEBC 125/...	12,5	17,20	172,00	37,84

CAPS - ANODISED SILVER ALUMINIUM/POLISHED CHROME/VARNISHED WHITE ALUM. - Pack. 10 Pcs (5 R 5 L) Pack. 2 Pcs (1R 1L)

Article	H mm	€/Pc	€/10 Pcs	€/2 Pcs
TPSHAA 08/...	8	8,96	89,60	19,71
TPSHBC 08/...	8	11,20	112,00	24,64
TPSHA 08/...	8	11,80	118,00	25,96
TPSHAA 10/...	10	8,96	89,60	19,71
TPSHBC 10/...	10	11,20	112,00	24,64
TPSHA 10/...	10	11,80	118,00	25,96
TPSHAA 125/...	12,5	8,96	89,60	19,71
TPSHBC 125/...	12,5	11,20	112,00	24,64
TPSHA 125/...	12,5	11,80	118,00	25,96

PROGUSCIO DA is a new corner joint (patented) with double flange, one of which is interchangeable with the profiles of the **PROTERMINAL** range H 6, 8, 10 mm. These floor/wall covering corner joints are recommended by European health and hygiene directives for cleanliness in public environments (hospitals, schools, offices, restaurants, changing rooms, kitchens, public baths, canteens, dwellings, etc.) Made in non-toxic, impact-resistant rigid vinyl resin (certificated), the product is also resistant to the sun's rays and most detergents and solvents. Hardwearing and easy to clean. The inside/outside corner linking elements, the end caps and the joint make for easy, perfect tiling. Attention: **PROTERMINAL** H 6 gives H 8, the H 8 gives H 10, the H 10 gives H 12.5.

PROGUSCIO DA

IMPACT-RESISTANT NON-TOXIC
COLOURED VINYL RESIN



EXAMPLES AND INSTRUCTIONS FOR LAYING METHODS

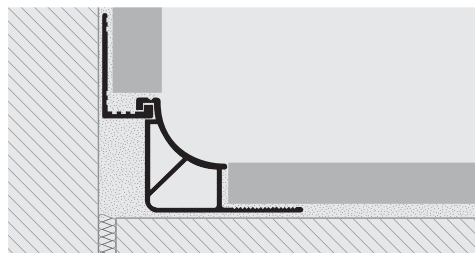
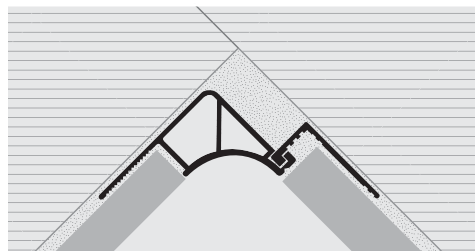

1. Choose the PROGUSCIO DA and the PROTERMINAL with suitable height for the thickness of the covering/floor. 2. Apply the adhesive onto the area of application of the profile. 3. Lay and align the profile, cut to the necessary length, pressing the perforated flange into the adhesive. 4. Lay the tiles, aligning them so that the top edge of the profile is flush with the tile and also joints, linking elements, etc. 5. Fill the profile/tile area of contact with adhesive to prevent the accumulation of water in any voids. Before laying the floor/wall covering, fix the profiles/joints to ensure perfect results.

IMPACT-RESISTANT NON-TOXIC VINYL RESIN

bar length 2,5 LM - packaging 20 Pcs - 50 LM

Article	H mm	€/LM	€/Pc
PS 06-...	6	3,08	7,70
PS 08-...	8	3,34	8,35
PS 10-...	10	3,49	8,73
PS 125-...	12,5	3,85	9,63

Available in the colours: 01-03-04. The code of the selected colour must be added to the article code. E.g.: PS 06... (chosen colour White) PS 06-01.

The interchangeable flange corresponds to White Proterminal pvc H: 6-8-10 mm.

COLOURS



(for a precise assessment of colours and finishes, see the relative enclosed sheet)

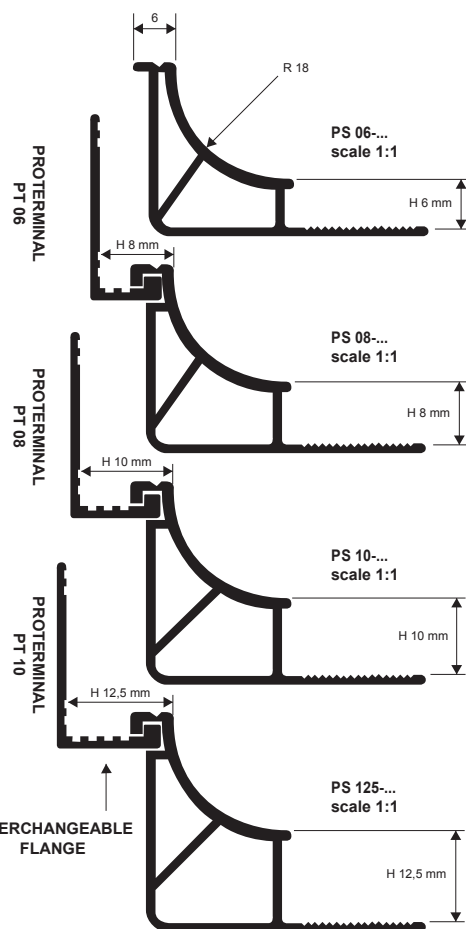

internal seal hygienic profiles

BUY WHITE PROTERMINAL TO CREATE THE DUAL HEIGHT (SEE ABOVE):
PROTERMINAL PT 06 = H 8 MM - H 8 MM
PROTERMINAL PT 08 = H 10 MM - H 10 MM
PROTERMINAL PT 10 = H 12,5 MM - H 12,5 MM

CORNERS, END CAPS and JOINTS

NON-TOXIC VINYL RESIN

OUTSIDE / INSIDE CORNER - RVA COLOURED

Pack. 10 Pcs - Pack. 2 Pcs

Article	H mm	€/ 2 Pcs	€/ 10 Pcs
RAI 06-... (inside)	6	4,10	19,42
RAI 08-... (inside)	8	4,10	19,42
RAI 10-... (inside)	10	4,10	19,42
RAI 125-... (inside)	12,5	4,10	19,42
RAE 06-... (outside)	6	4,10	19,42
RAE 08-... (outside)	8	4,10	19,42
RAE 10-... (outside)	10	4,10	19,42
RAE 125-... (outside)	12,5	4,10	19,42

Available in the colours: 01 - 03 - 04. The code of the selected colour must be added to the article code. E.g.: RAI 06-... (chosen colour White) RAI 06-01.

END CAP RT / LF AND JOINTS - RVA COLOURED

Pack. 10 Pcs (5 right and 5 left) - Pack. 2 Pcs (1 right and 1 left)

Article	H mm	€/ 2 Pcs	€/ 10 Pcs
TCE 08-... caps RT-LF	8	3,70	17,60
TCE 10-... caps RT-LF	10	3,70	17,60
TCE 125-... caps RT-LF	12,5	3,70	17,60
GIN 08-...	8	3,70	17,60
GIN 10-...	10	3,70	17,60
GIN 125-...	12,5	3,70	17,60

Available in the colours: 01 - 03 - 04. The code of the selected colour must be added to the article code. E.g.: RAI 06-... (chosen colour White) RAI 06-01.



PROJOLLY - PROJOLLY QUART

RAI 06/08/10/125-...

RAE 06/08/10/125-...

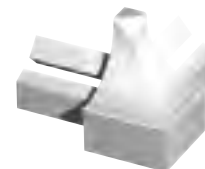
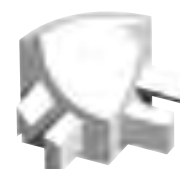

TCE 08/10/125-...

GIN 08/10/125-...



PROROUND

POLISHED AND SATINED
STAINLESS STEEL AISI 304/1.4301-V2A

PROROUND is a hygienic joint applied between existing floors and abutting surfaces. Compulsory for compliance with national health regulations and European directives in public environments. It facilitates the cleaning of inside corners, is easy to lay with self-adhesive silicone and resists detergents and solvents. Made in AISI 304/1.4301-V2A stainless steel, it is resistant to all products. Recommended for butchers', hospitals and chemical laboratories. The prewelded inside, outside and three-way corner linking elements facilitate faultless laying.

internal seal hygienic profiles

PRDAC/S 35
PRDAC/S 35A
scale 1:1

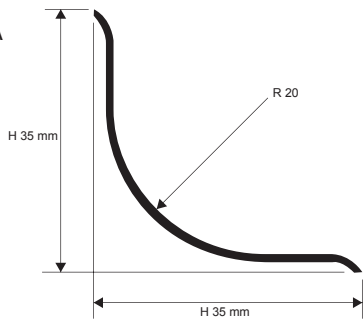

EXEMPLES OF LAYING

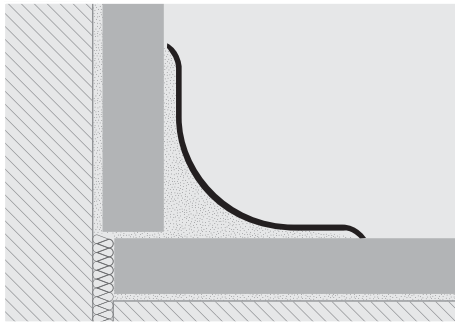

POLISHED STAINLESS STEEL AISI 304/1.4301-V2A with protective film - 35 x 35 mm - bar length 2,7 LM - packaging 20 Pcs - 54 LM

Article	H mm	€/LM	€/Pc
PRDAC 35	35	11,70	31,59
PRDAC 35A (with adhesive)	35	14,52	39,20



SATINED STAINLESS STEEL AISI 304/1.4301-V2A with protective film 35 x 35 mm - bar length 2,7 LM - packaging 20 Pcs - 54 LM

Article	H mm	€/LM	€/Pc
PRDACS 35	35	14,19	38,31
PRDACS 35A (with adhesive)	35	17,02	45,95

COLOURS



(for a precise assessment of colours and finishes, see the relative enclosed sheet)

LAYING INSTRUCTIONS

1. Choose the suitable PROROUND for covering the inside corner of the wall covering/floor. 2. Clean the surface on which the profile is to be laid, ensuring that it is grease-free and dry. Application is recommended at a temperature of at least 15°. 3. Remove the protective paper from the adhesive and lay correctly by applying pressure evenly over the whole profile without using a hammer. 4. Use the inside, outside and three-way corner linking elements in the corners.

SUITABLE FOR USE IN CONTACT WITH FOODSTUFFS

PREWELDED JOINTS without gaps

POLISHED and SATINED STAINLESS STEEL

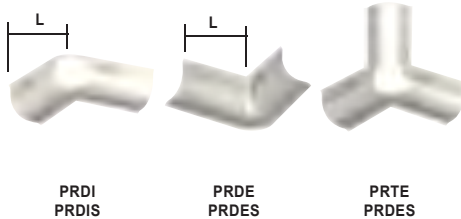

POLISHED STAINLESS STEEL AISI 304/1.4301 - Pack. 10 Pcs

Article	L mm	€/Pc	€/pack.
PRDI (inside)	100	16,74	167,40
PRDE (outside)	100	16,74	167,40
PRTE (three-way)	80	22,18	221,80

SATINED STAINLESS STEEL AISI 304/1.4301 - Pack. 10 Pcs

Article	L mm	€/Pc	€/pack.
PRDIS (inside)	100	17,77	177,70
PRDES (outside)	100	17,77	177,70
PRTES (three-way)	80	24,24	242,40

PROSANI STRIP & KIT

FLEXIBLE NON - TOXIC
WHITE VINYL RESIN

PROSANI STRIP is a flexible hygienic profile used to protect and finish the joint between wall coverings and sanitary ware, bathtubs and hydromassage baths, shower trays, kitchen worktops, etc. **PROSANI STRIP** prevents infiltration of water and gradual deterioration of silicone fillers, since it is 100% waterproof. **PROSANI STRIP** is applied at the time of installation. Two rolls of double-sided adhesive are supplied for application on the upper surface. The internal circular hollow helps the silicone inserted in the corner to increase adherence.

internal seal hygienic profiles

PSS 10
scale 1:1

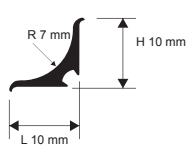

PSS 1035
scale 1:1

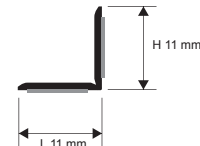

EXAMPLES AND INSTRUCTIONS FOR LAYING METHODS

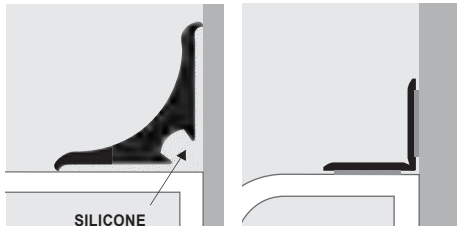

1. Unroll the profile and cut off the required length. 2. Apply a thread of fast-setting silicone in the corner between the wall covering and the sanitary ware (PSS 10). 3. Lay the profile, press until it is buried in the silicone and keep pressing as long as possible until the silicone starts setting. 4. Add silicone on the open sides to ensure perfect fixing of the whole profile.



FLEXIBLE WHITE VINYL RESIN
roll 25 LM

Article	LxH mm	€/LM	€/roll
PSS 10	10 x 10	3,24	81,00



COLOURS



(for a precise assessment of colours and finishes, see the relative enclosed sheet)

PROSANI STRIP KIT ROLL - WHITE
roll 3,5 LM

Article	LxH mm	€/LM	€/roll
PSS 1035	11 x 11	0,72	2,52

PROSEAL 50 is hygienic cove-shaped joint between existing floors and abutting surfaces. Compulsory in public environments for compliance with national health regulations and European directives. It facilitates the cleaning of inside corners, is easy to lay with self-adhesive silicone and resists detergents and solvents. Made in impact-resistant vinyl resin in the three standard colours. The inside/outside and three-way corner linking elements, the end caps and the central joint facilitate faultless laying.

PROSEAL 50

RIGID/FLEXIBLE IMPACT-RESISTANT
NON-TOXIC COEXTRUDED
COLOURED VINYL RESIN



COEXTRUDED VINYL RESIN NON-TOXIC IMPACT-RESISTANT
bar length 2,5 LM

Article	€/LM	€/Pc
PSA 50-... pack. 40 LM	7,14	17,85
PSA 50-... A pack. 30 LM (with adhesive)	9,86	24,65

Available in the colours: 01 - 03 - 04.

The code of the selected colour must be added to the article code.
E.g.: PSA 50... (chosen colour White) PSA 50-01.



PSA 50-... / PSA 50-... A
scale 1:1

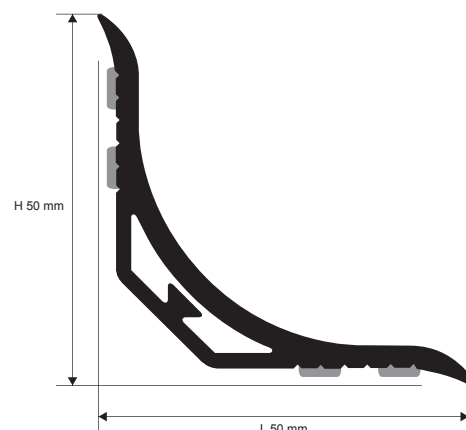

internal seal hygienic profiles

EXAMPLES AND INSTRUCTIONS FOR LAYING METHODS

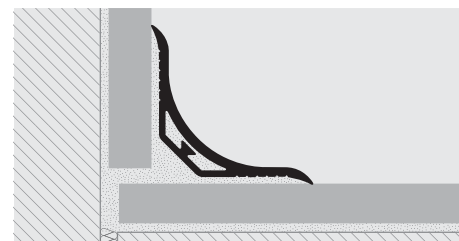

1. Choose the PROSEAL in the required colour and type. 2. Clean the surface on which the profile is to be laid, ensuring that it is grease-free and dry. Application is recommended at a temperature of at least 15°.
 3. Remove the protective paper from the adhesive, or in the version without adhesive apply a thread of silicone, and lay correctly by applying pressure evenly over the whole profile without using a hammer. Use the inside, outside and three-way corner linking elements in the corners, always applying silicone to fix them.
- IMPORTANT:** The PROSEAL sticking version must not be applied on porous surfaces.
Use suitable silicone for porous surfaces.

COLOURS

(for a precise assessment of colours and finishes, see the relative enclosed sheet)



INSIDE / OUTSIDE CORNERS and END CAPS

NON-TOXIC VINYL RESIN

inside / outside corner and END CAPS (for PROSEAL 50)

Pack. 10 Pcs

Article	€/10 Pcs	€/2 Pcs
TRI 50-... (inside corner)	7,20	34,02
TRE 50-... (outside corner)	7,20	34,02
TRT 50-... (three-way corner)	7,20	34,02
TRC 50-... (end cap)	7,20	34,02
TGN 50-... (joints)	7,20	34,02

Available in the colours: 01 - 03 - 04.

The code of the selected colour must be added to the article code.
E.g.: TRI 50... (chosen colour White) TRI 50-01.

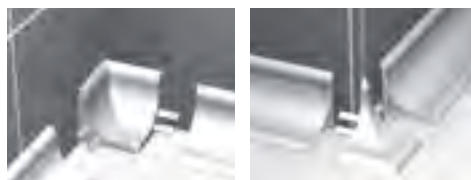
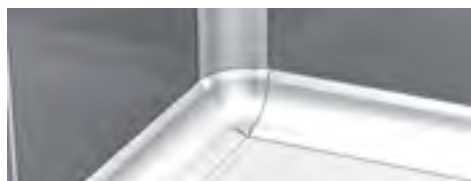

TRE 50-...

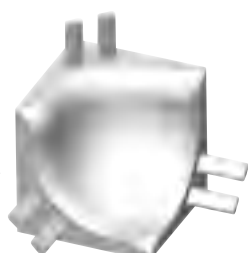

TRT 50-...



TRC 50-...



TGN 50-...

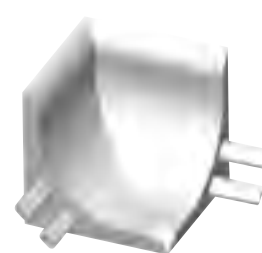

TRI 50-...

PROSEAL 25

RIGID/FLEXIBLE IMPACT-RESISTANT
NON-TOXIC COEXTRUDED
COLOURED VINYL RESIN

PROSEAL 25 is hygienic cove-shaped joint between existing floors and abutting surfaces. Compulsory in public environments for compliance with national health regulations and European directives. It facilitates the cleaning of inside corners, is easy to lay with self-adhesive silicone and resists detergents and solvents. Made in impact-resistant vinyl resin in the three standard colours. The inside/outside and three-way corner linking elements, the end caps and the central joint facilitate faultless laying.

internal seal hygienic profiles

PSA 25-...
PSA 25-... A
scale 1:1

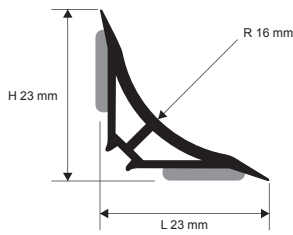

EXAMPLES AND INSTRUCTIONS FOR LAYING METHODS

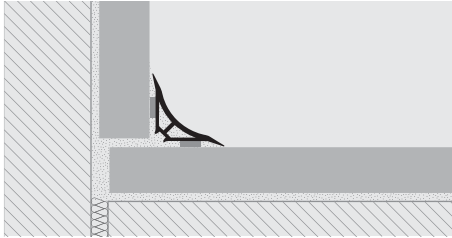

1. Choose the PROSEAL in the required colour and type. 2. Clean the surface on which the profile is to be laid, ensuring that it is grease-free and dry. Application is recommended at a temperature of at least 15°.
 3. Remove the protective paper from the adhesive, or in the version without adhesive apply a thread of silicone, and lay correctly by applying pressure evenly over the whole profile without using a hammer.
 4. Use the inside, outside and three-way corner linking elements in the corners, always applying silicone to fix them.
- IMPORTANT:** The PROSEAL sticking version must not be applied on porous surfaces. Use suitable silicone for porous surfaces.



COEXTRUDED VINYL RESIN NON-TOXIC IMPACT-RESISTANT
bar length 2,5 LM

Article	€/LM	€/Pc
PSA 25-... pack. 50 LM	3,29	8,23
PSA 25-... A pack. 50 LM (with adhesive)	5,24	13,10

Available in the colours: 01 - 03 - 04.
The code of the selected colour must be added to the article code.
E.g.: PSA 25-... (chosen colour White) PSA 25-01.

PROSEAL KIT 25 (1 PC OF 1,80 LM + 2 PCS OF 0,90 LM + 2 INSIDE CORNERS and 2 END CAPS 1 R and 1 L)

Descrizione	Articolo	€/KIT
Kit PROSEAL 25	KTPSA 25-01	27,00
1 Pc PROSELAL 25 of 1,80 LM	PSA 25-01	
2 Pc PROSELAL 25 of 0,90 LM	PSA 25-01	
2 Inside corner	TRI 25-01	
2 End caps	TRC 2501	

News 2015 available from February

COLOURS

(for a precise assessment of colours and finishes, see the relative enclosed sheet)



INSIDE / OUTSIDE CORNERS AND END CAPS

NON-TOXIC VINYL RESIN

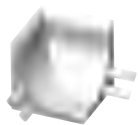

TRI 25-...



TRE 25-...



TRT 25-...



TRC 25-...



TGN 25-...

INSIDE / OUTSIDE CORNERS AND END CAPS (for PROSEAL 25)

Pack. 10 Pcs - Pack. 2 Pcs

Article	€/ 2 Pcs	€/ 10 Pcs
TRI 25-... (inside corner)	4,40	20,90
TRE 25-... (outside corner)	4,40	20,90
TRT 25-... (three-way corner)	4,40	20,90
TRC 25-... (end cap)	4,00	20,00
TGN 25-... (joints)	4,00	20,00

Available in the colours: 01 - 03 - 04.
The code of the selected colour must be added to the article code.
E.g.: TRI 25-... (chosen colour White) TRI 25-01.

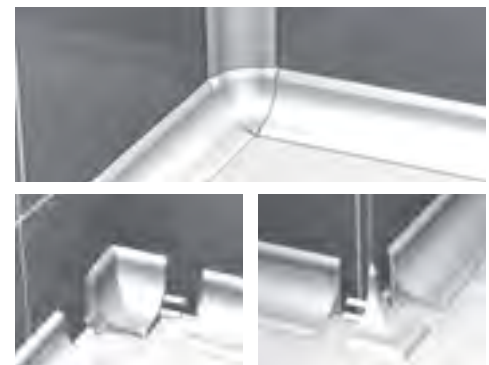

PROBATH 20 & 15 are Rigid/Soft co-extruded hygienic concave square connectors to apply between walls and work tops (ex. coverings). Very suitable for traditional and Whirlpool baths, shower units etc. It facilitates the cleaning in the inner angles and prevents from the appearance of silicone that has been blackened by time. Resistant to detergents and solvents normally used for interior cleaning. In co-extruded anti-mould non toxic shockproof vinyl resin and white flexible. Outer/inner and three ways angles connectors, the locking caps and the joints facilitate and improve the laying. Available only for **PROBATH 20 & PROBATH FLEX 20** models.

PROBATH

RIGID/FLEXIBLE IMPACT-RESISTANT
NON-TOXIC COEXTRUDED VINYL RESIN



CO-EXTRUDED VINYL RESIN NON-TOXIC IMPACT-RESISTANT
bar length 2,5 ML - packaging 40 Pcs - 100 LM

Article	H mm	€/LM	€/Pc
PSB 15-01	15	3,50	9,45
PSB 20-01	20	4,50	12,15

AVAILABLE IN WHITE

PROBATH KIT (1 PC OF 1,80 LM + 2 PCS OF 0,90 LM + 2 INSIDE CORNERS and 2 END CAPS 1 R and 1 L)

Descrizione	Articolo	€/KIT
Kit PROBATH	KTPSB 20-01	26,50
1 Pc PROBATH of 1,80 LM	PSB 20-01	
2 Pc PROBATH of 0,90 LM	PSB 20-01	
2 Inside corner	TRI 25-01	
2 End caps	TRC 2501	

COLOURS

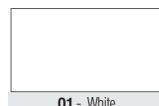

For other colors minimum order 1000 LM

PSB 15-01
scale 1:1

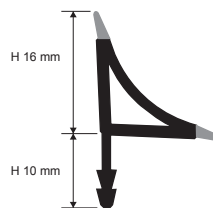

PSB 20-01
scale 1:1

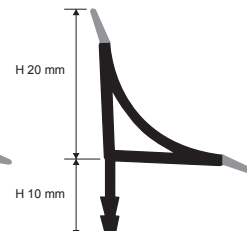

internal seal hygienic profiles

EXAMPLES OF LAYING

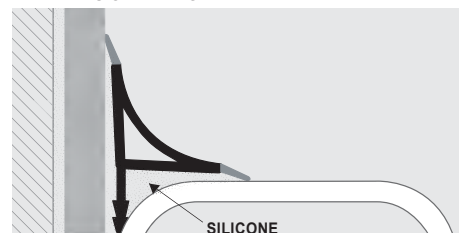

PROBATH FLEX 20" & PROBATH FLEX 15" are flexible co-extruded hygienic concave square connectors to apply in the traditional and Whirlpool baths with regular and irregular shapes or between walls and work tops. (ex. coverings). It can be used for shower units. It facilitates the cleaning in the inner angles and prevents from infiltrations and the appearance of silicone that has been blackened by time. Resistant to detergents and solvents normally used for interior cleaning. In co-extruded anti-mould non toxic shockproof vinyl resin and white flexible. The outer/inner and three ways angles connectors, the locking caps and the joints facilitate and improve the laying. Available only for **PROBATH 20 & PROBATH FLEX 20** models.



FLEXIBLE WHITE VINYL RESIN
bar length 2,5 ML - packaging 40 Pcs - 100 LM

Article	H mm	€/LM	€/Pc
PSBF 15-01	15	4,10	13,63
PSBF 20-01	20	5,10	16,20

AVAILABLE ONLY IN WHITE

COLOURS

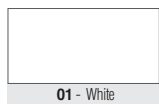

(for a precise assessment of colours and finishes, see the relative enclosed sheet)

PSBF 15-01
scale 1:1

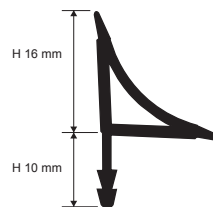

PSBF 20-01
scale 1:1

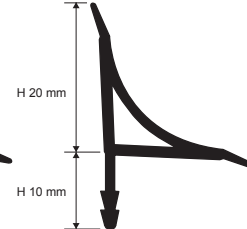

internal seal hygienic profiles

LAYING INSTRUCTIONS

1. Choose the PROBATH corresponding to the required width and typology.
2. Clean the support surface caring that it is degreased and dry. A temperature not below 15° should be set to apply it.
3. Apply a stripe of silicone on both inner sides and lay carefully exerting a uniform pressure without hammering.
4. Use inner-outer-three ways connectors still using silicone to fix it (for PROBATH 20 & PROBATH FLEX 20 models).

INSIDE / OUTSIDE / THREE-WAYS CORNER AND END CAPS

NON-TOXIC VINYL RESIN

CORNER JOINTS INSIDE / OUTSIDE / AND THREE-WAYS
Pack. 10 Pcs - Pack. 2 Pcs

Article	€/ 2 Pcs	€/ 10 Pcs
TRI 25-01 (inside corner)	4,40	20,90
TRE 25-01 (outside corner)	4,40	20,90
TRT 25-01 (three-way corner)	4,40	20,90
TRC 25-01 (end cap)	4,00	20,00
TGN 25-01 (joints)	4,00	20,00
RIPSB 15-01 (inside corner joints)	4,40	20,90
REPSB 15-01 (outside corner joints)	4,40	20,90
RIPSBF 15-01 (inside corner joints)	4,40	20,90
REPSBF 15-01 (outside corner joints)	4,40	20,90

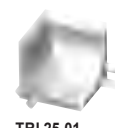

CAPS - (for PSB 20 - PSBF 20) - Pack. 10 Pcs - Pack. 2 Pcs

Article	€/ 2 Pcs	€/ 10 Pcs
TPSB 15-01	4,00	20,00
TPSBF 15-01	4,00	20,00



REPSB 15-01
REPSBF 15-01

TRT 25-01

TPSB 15-01
TPSBF 15-01

RIPSB 15-01
REPSB 15-01

The colour of the joints is fit for rigid vinyl resin/pvc, but its shade results slightly different from the one in flexible vinyl resin/pvc (probath flex).



PROJOLLY SQUARE a square shaped as a right angle that is versatile and suitable for various laying solutions, both for floors and coverings. It is used as a staff angle for external corners of tile coverings. It facilitates laying and eliminates the brittle unpredictability of Kerlite/Laminam and thin ceramic tiles besides the mosaic. It is also used as a finishing square for terminating wall coverings, raised platforms, steps, and bath tubs. It is ideal as a corner and as skirting for parquet, natural stone, carpet and epoxy resin coverings. It guarantees flawless work done with care that is of great aesthetic value. It strengthens the edge efficiently protecting corners, avoiding chipping and breakages resulting from knocks. This is required by the new European regulations on safety and accident prevention in public areas, but even in private ones.

PROJOLLY SQUARE

POLISHED, SUPER POLISHED AND SATINED STAINLESS STEEL AISI 304/1.4301-V2A



POLISHED STAINLESS STEEL AISI 304/1.4301-V2A with protective film - bar length 2,7 LM - packaging 40 Pcs - 108 LM - 8/10mm

Article	H mm	€/LM	€/Pc
PJQAC 045	4,5	7,70	20,79
PJQAC 06	6	8,11	21,90

SATINED STAINLESS STEEL AISI 304/1.4301-V2A with protective film bar length 2,7 LM - packaging 40 Pcs - 108 LM - 8/10mm

Article	H mm	€/LM	€/Pc
PJQACS 045	4,5	8,93	24,11
PJQACS 06	6	9,40	25,38

SUITABLE FOR USE IN CONTACT WITH FOODSTUFFS



SUPER POLISHED STAINLESS STEEL AISI 304/1.4301-V2A thermo packed - bar length 2,7 LM - Pack. 40 Pcs 108 LM - 8/10mm

Article	H mm	€/LM	€/Pc
PJQACML 045	4,5	10,37	28,00
PJQACML 06	6	10,94	29,54



COLOURS



(for a precise assessment of colours and finishes, see the relative enclosed sheet)

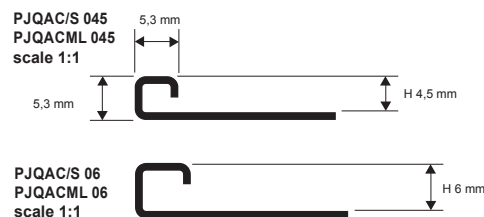

EXAMPLES AND INSTRUCTIONS FOR LAYING METHODS

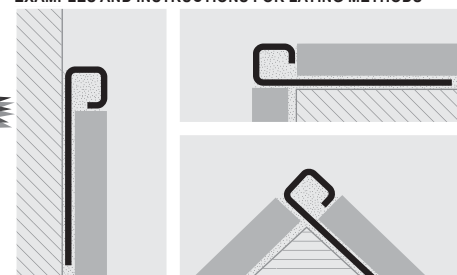

1. Choose the PROJOLLY SQUARE whose height corresponds to covering/floor thickness.
2. Apply the adhesive in the area that the square is being applied.
3. Rest and line up the square, cut to the required length, pressing the perforated tab into the adhesive.
4. Lay the tiles lining them up so that the upper part of the square meets with their edge.
5. Fill the contact area between square and tile completely with adhesive to prevent the accumulation of water in the empty spaces.

profiles for low thicknesses

© 2011 All rights reserved by Progress Profiles. Printed in Italy

CAPSULES, CAPS and three - axial JOINTS

POLISHED, SUPER POLISHED and SATINED STAINLESS STEEL AISI 304/1.4301-V2A / PLASTIC

CAPSULES and CAPS - POLISHED STAINLESS STEEL AISI 304/1.4301-V2A

Article	H mm	€/Pc	€/pack. 10 pcs	€/pack. 2 pcs
CPJQAC 045/...	4,5	11,96	119,60	25,16
TPJQAC 045/...	4,5	2,26	22,60	4,93
CPJQAC 06/...	6	11,96	119,60	25,16
TPJQAC 06/...	6	2,26	22,60	4,93

Choose the desired packaging: E.g. CPJQAC .../10 (pack 10 pcs)
CPJQAC .../2 (pack 2 pcs)

CAPSULES - SUPER POLISHED STAINLESS STEEL AISI 304/1.4301-V2A

Article	H mm	€/Pc	€/pack. 10 pcs	€/pack. 2 pcs
CPJQACML 045/...	4,5	14,89	148,90	31,32
CPJQACML 06/...	6	14,89	148,90	31,32

Choose the desired packaging.
E.g. CPJQACML .../10 (pack 10 pcs)
CPJQACML .../2 (pack 2 pcs)



CAPSULE
CPJQAC 045/...
CPJQACS/ML 045/...

JOINT
GIJQ 045/...

END CAP
TPJQAC/S 045/...

CAPSULES and CAPS - SATINED STAINLESS STEEL AISI 304/1.4301-V2A

Article	H mm	€/Pc	€/pack. 10 pcs	€/pack. 2 pcs
CPJQACS 045/...	4,5	13,45	134,50	28,24
TPJQACS 045/...	4,5	2,26	22,60	4,93
CPJQACS 06/...	6	13,45	134,50	28,24
TPJQACS 06/...	6	2,26	22,60	4,93

Choose the desired packaging: E.g. CPJQACS .../10 (pack 10 pcs)
CPJQACS .../2 (pack 2 pcs)

JOINTS - PLASTIC

Article	H mm	€/Pc	€/pack. 10 pcs	€/pack. 2 pcs
GIJQ 045/...	4,5	2,16	21,60	4,72
GIJQ 06/...	6	2,16	21,60	4,72

Choose the desired packaging: E.g. GIJQ .../10 (pack 10 pcs)
GIJQ .../2 (pack 2 pcs)



profiles for low thicknesses

PROJOLLY SQUARE

CHROMED BRASS

PROJOLLY SQUARE is a square shaped as a right angle that is versatile and suitable for various laying solutions, both for floors and coverings. It is used as a staff angle for external corners of tile coverings. It facilitates laying and eliminates the brittle unpredictability of ceramic tiles. It is also used as a finishing square for finishing wall coverings, raised platforms, steps, and baths, and is used as an edge and a skirting board for parquet, natural stone, moquette and epoxy resin coverings. It guarantees flawless work done with care that is of great aesthetic merit. It strengthens tile edges with a square finish, protecting corners efficiently, avoiding chipping and breakages resulting from knocks. This is required by the new European regulations on safety and accident prevention in public and private places.

profiles for low thicknesses



EXEMPLES OF LAYING

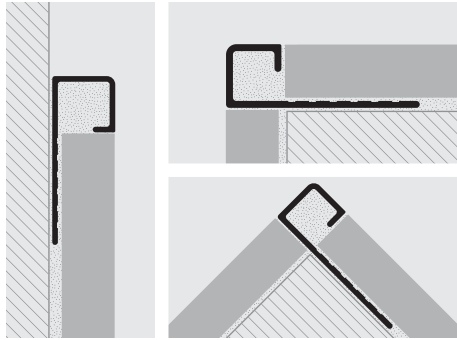

CHROMED BRASS thermo packed
bar length 2,7 LM - packaging 20 Pcs - 54 LM

Article	H mm	€/LM	€/Pcs
PJQOC 045	4,5	14,89	40,20
PJQOC 06	6	8,11	21,90

CAPSULES and CAPS - CHROMED BRASS

Article	H mm	€/Pc	€/Pack 10 pcs	€/Pack 2 pcs
CPJQOC 045/...	4,5	11,96	119,60	25,16 *
CPJQOC 06/...	6	11,96	119,60	25,16 *
TPJQOC 045-06/...	4,5-6	2,26	22,60	4,93

Choose the desired packaging: E.g. CPJQOC .../10 (pack 10 pcs)
CPJQOC .../2 (pack 2 pcs)

LAYING INSTRUCTIONS

1. Choose a PROJOLLY SQUARE height corresponding to the thickness of the covering/floor. 2. Apply the adhesive in the area that the square is being applied. 3. Rest and line up the square, cut to the required length, pressing the perforated tab into the adhesive. 4. Place the tiles lining them up so that the upper part of the square meets with their edge. 5. Fill the contact area between square and tile completely with adhesive to prevent the accumulation of water in the empty spaces.

IMPORTANT: Pay much attention to the external edges of Projolly in chrome brass. They must be protected against aggressive substances such as adhesives and sealing elements as well as against smoothing and scraping activities.

COLOURS



(for a precise assessment of colours and finishes, see the relative enclosed sheet)

= News 2015 available from February

JOINTS

PLASTIC

JOINTS - PLASTIC

Article	H mm	€/Pc	€/Pack 10 pcs	€/Pack 2 pcs
GIJQ 045-06/...	4,5-6	2,16	21,60	4,72

Choose the desired packaging: E.g. GIJQ .../10 (pack 10 pcs)
GIJQ .../2 (pack 2 pcs)



JOINT
GIJQ 045-06/...

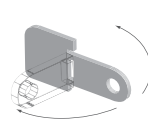

END CAP
TPJQOC 045-06/...



CPJQOC 045-06/...

* = Upon request, price and delivery time to be agreed.



PROJOLLY SQUARE a square shaped as a right angle that is versatile and suitable for various laying solutions, both for floors and coverings. It is used as a staff angle for external corners of tile coverings. It facilitates laying and eliminates the brittle unpredictability of Kerlite/Laminam and thin ceramic tiles besides the mosaic. It is also used as a finishing square for terminating wall coverings, raised platforms, steps, and bath tubs. It is ideal as a corner and as skirting for parquet, natural stone, carpet and epoxy resin coverings. It guarantees flawless work done with care that is of great aesthetic value. It strengthens the edge efficiently protecting corners, avoiding chipping and breakages resulting from knocks. This is required by the new European regulations on safety and accident prevention in public areas, but even in private ones.



PROJOLLY SQUARE

ANODISED, POLISHED AND BRUSHED ALUMINIUM

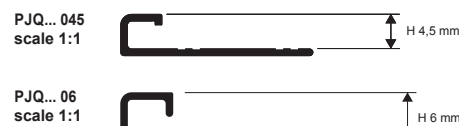

profiles for low thicknesses

ANODISED ALUMINIUM (silver-copper-titanium) thermo packed bar length 2,7 LM - packaging 40 Pcs - 108 LM

Article	H mm	€/LM	€/Pcs
PJQAA 045 (anod. silver)	4,5	4,31	11,64
PJQAR 045 (anod. copper)	4,5	5,49	14,82
PJQAT 045 (anod. titanium)	4,5	4,52	12,20
PJQAA 06 (anod. silver)	6	4,31	11,64
PJQAR 06 (anod. copper)	6	5,75	15,53
PJQAT 06 (anod. titanium)	6	4,78	12,91

POLISHED ALUMINIUM (chrome-polished titanium-copper) thermo packed bar length 2,7 LM - packaging 40 Pcs - 108 LM

Article	H mm	€/LM	€/Pcs
PJQBC 045 (polished chrome)	4,5	7,14	19,28
PJQBT 045 (polished titanium)	4,5	7,14	19,28
PJQBR 045 (polished copper)	4,5	7,14	19,28
PJQBC 06 (polished chrome)	6	7,14	19,28
PJQBT 06 (polished titanium)	6	7,14	19,28
PJQBR 06 (polished copper)	6	7,14	19,28

BRUSHED ALUMINIUM (silver-copper-titanium) thermo packed bar length 2,7 LM - packaging 40 Pcs - 108 LM

Article	H mm	€/LM	€/Pc
PJQBS 045 (brush. silver)	4,5	7,75	20,93
PJQRS 045 (brush. copper)	4,5	7,75	20,93
PJQTS 045 (brush. titanium)	4,5	7,75	20,93
PJQBS 06 (brush. silver)	6	8,01	21,63
PJQRS 06 (brush. copper)	6	8,01	21,63
PJQTS 06 (brush. titanium)	6	8,01	21,63

EXAMPLES AND INSTRUCTIONS FOR LAYING METHODS

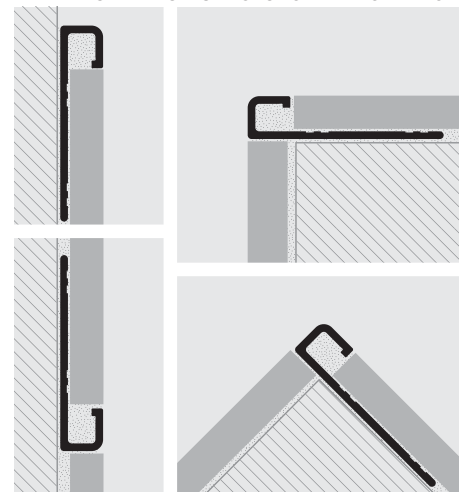

1. Choose the PROJOLLY SQUARE whose height corresponds to covering/floor thickness.
 2. Apply the adhesive in the area that the square is being applied.
 3. Rest and line up the square, cut to the required length, pressing the perforated tab into the adhesive.
 4. Lay the tiles lining them up so that the upper part of the square meets with their edge.
 5. Fill the contact area between square and tile completely with adhesive to prevent the accumulation of water in the empty spaces.
- IMPORTANT:** Take care of the external edges of the aluminium Projolly square. They must be protected from aggressive substances such as adhesives and sealants and from smoothing or scraping action.

© 2011 All rights reserved by Progress Profiles. Printed in Italy

COLOURS

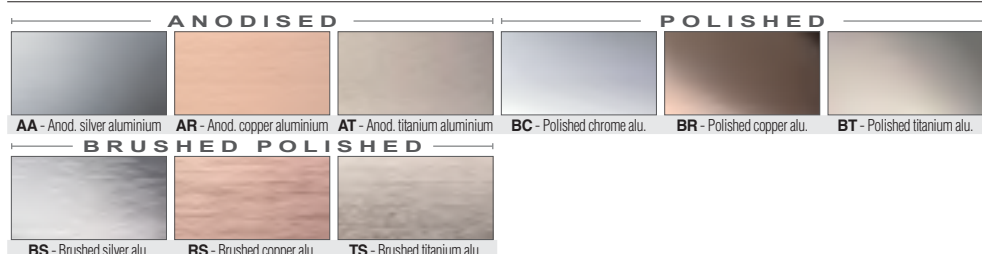

CAPSULES, CAPS and three - axial JOINTS

ANODISED, POLISHED and BRUSHED ALUMINIUM / PLASTIC

CAPSULES and CAPS - ANODISED ALUMINIUM

Article	H mm	€/Pc	€/pack. 10 pcs	€/pack. 2 pcs
CPJQAA 045/...	4,5	3,90	39,00	8,73
CPJQAR 045/...	4,5	5,55	55,50	11,81
CPJQAT 045/...	4,5	5,55	55,50	11,81
TPJQ... 045/...	4,5	2,26	22,60	4,93
CPJQAA 06/...	6	3,90	39,00	8,73
CPJQAR 06/...	6	5,55	55,50	11,81
CPJQAT 06/...	6	5,55	55,50	11,81
TPJQ... 06/...	6	2,26	22,60	4,93

Available in the finishes: AA - AR - AT. The code of the selected colour must be added to the article code. E.g: CPJQ...045/... (chosen finish Anod. silver) CPJQAA 045/10.

JOINTS - PLASTIC

Article	H mm	€/Pc	€/pack. 10 pcs	€/pack. 2 pcs
GIJQ 045/...	4,5	2,16	21,60	4,72
GIJQ 06/...	6	2,16	21,60	4,72



CAPSULE
CPJQ... 045/...



JOINT
TPJQ... 045/...



END CAP
GIJQ 045/...

CAPSULES and CAPS - POLISHED AND BRUSHED ALUMINIUM

Article	H mm	€/Pc	€/pack. 10 pcs	€/pack. 2 pcs
CPJQBC 045/...	4,5	3,90	39,00	8,73
CPJQBT 045/...	4,5	5,55	55,50	11,81
CPJQBR 045/...	4,5	5,55	55,50	11,81
CPJQBS 045/...	4,5	5,55	55,50	11,81
CPJQRS 045/...	4,5	5,55	55,50	11,81
CPJQTS 045/...	4,5	5,55	55,50	11,81
TPJQ 045/...	4,5	2,26	22,60	4,93
CPJQBC 06/...	6	3,90	39,00	8,73
CPJQBT 06/...	6	5,55	55,50	11,81
CPJQBR 06/...	6	5,55	55,50	11,81
CPJQBS 06/...	6	5,55	55,50	11,81
CPJQRS 06/...	6	5,55	55,50	11,81
CPJQTS 06/...	6	5,55	55,50	11,81
TPJQ 06/...	6	2,26	22,60	4,93

Available in the finishes: BC - BT - BR - BS - RS - TS. The code of the selected colour must be added to the article code. E.g: CPJQ...045/... (chosen finish Brushed copper) CPJQRS 045/10.

* = Upon request, price and delivery time to be agreed.

Prices are referred to whole packs. 10% increase for minimum orders of 10 pcs. 20% increase for orders of less than 10 pcs.

PROKERLAM SQUARE

ANODISED POLISHED SILVER, CHROME,
GOLD ALUMINIUM

PROKERLAM SQUARE is a new product conceived and designed with a square shape for laying thin ceramic tiles: Kerlite, Laminam, and for mosaic. Two small teeth on the ends allow the glue / adhesive to anchor perfectly to the profile. It protects the corner creating a technical-chromatic effect that is of great aesthetic value. Available in these colours AA – ANODISED SILVER aluminium , BC – Chromed polished aluminium, e BO – Gold polished aluminium; with a height of 4.5 mm.

profiles for low thicknesses

PKLQ... 045
scale 1:1

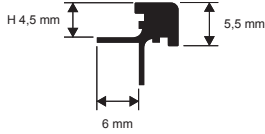

EXEMPLES OF LAYING

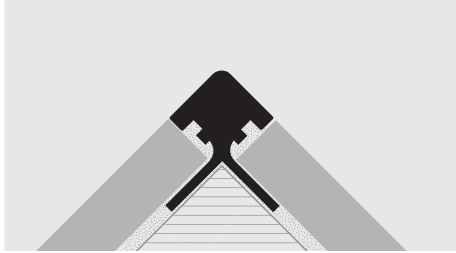

ANODISED SILVER ALUMINIUM thermo packed
bar length 2,7 LM - packaging 40 Pcs - 108 LM

Article	H mm	€/LM	€/Pc
PKLQAA 045	4,5	5,24	14,15

POLISHED GOLD/CHROME ALUMINIUM thermo packed
bar length 2,7 LM - packaging 40 Pcs - 108 LM

Article	H mm	€/LM	€/Pc
PKLQBC 045	4,5	8,11	21,90
PKLQBO 045	4,5	8,11	21,90

PRODUCTION ON DEMAND. PRICE AND DELIVERY TIME TO BE AGREED.

ISTRUZIONI TECNICHE DI POSA

1. Choose the PROKERLAM SQUARE of the desired surface finish. 2. Apply the adhesive in the area that the square is being applied. 3. Rest and line up the square, cut to the required length, pressing the tabs into the adhesive. 4. Lay the Kerlite/ Laminam/ Mosaic tiles lining them up so that the upper part of the square meets with their edge. 5. Fill the contact area between square and covering completely with adhesive to prevent the accumulation of water in the empty spaces. **IMPORTANT:** Take care of the external edges of the aluminium Prokerlam. They must be protected from aggressive substances such as adhesives and sealants and from smoothing or scraping action.



COLOURS



PROKERLAM JOLLY

ANODISED POLISHED SILVER, CHROME,
GOLD ALUMINIUM

PROKERLAM JOLLY is a new product conceived and designed with a rounded shape, for laying thin ceramic tiles: Kerlite, Laminam, and for mosaic. Two small teeth on the ends allow the glue / adhesive to anchor perfectly to the profile. It protects the corner creating a technical-chromatic effect that is of great aesthetic value. Available in these colours AA – ANODISED SILVER aluminium , BC – Chromed polished aluminium, e BO – Gold polished aluminium; with a height of 4.5 mm

profiles for low thicknesses

PKLJ... 045
scale 1:1

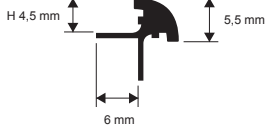

EXEMPLES OF LAYING (for laying instructions, see Prokerlam square)

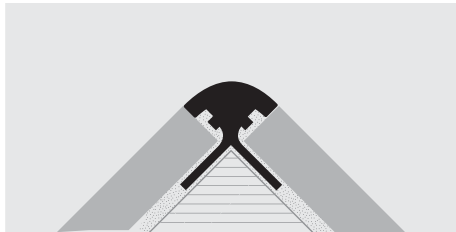

ANODISED SILVER ALUMINIUM thermo packed
bar length 2,7 LM - packaging 40 Pcs - 108 LM

Article	H mm	€/LM	€/Pc
PKLJAA 045	4,5	5,08	13,72

PRODUCTION ON DEMAND. PRICE AND DELIVERY TIME TO BE AGREED.

POLISHED GOLD/CHROME ALUMINIUM thermo packed
bar length 2,7 LM - packaging 40 Pcs - 108 LM

Article	H mm	€/LM	€/Pc
PKLJBC 045	4,5	7,91	21,36
PKLJBO 045	4,5	7,91	21,36

COLOURS



PROKERLAM LINE

ANODISED POLISHED SILVER, CHROME,
GOLD ALUMINIUM

PROKERLAM line is a new product conceived and designed with an almost invisible thin profile in order to reduce separation of the material to a minimum, for laying thin ceramic tiles: Kerlite/Laminam, and for mosaic. The notching created at the ends of the profiles allows the glue / adhesive to anchor perfectly to the profile. It protects the corner creating a technical-chromatic effect that is of great aesthetic value. Available in these colours AA – ANODISED SILVER aluminium , BC – Chromed polished aluminium, e BO – Gold polished aluminium.

profiles for low thicknesses

PKLL... 045
scale 1:1

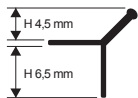

PKLL... 10
scale 1:1

PKLL... 125
scale 1:1

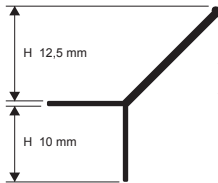
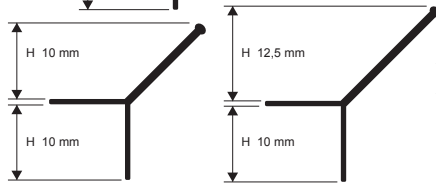

EXEMPLES OF LAYING (for laying instructions, see Prokerlam square)



ANODISED SILVER ALUMINIUM thermo packed
bar length 2,7 LM - packaging 40 Pcs - 108 LM

Article	H mm	€/LM	€/Pc
PKLLAA 045	4,5	4,11	11,10
PKLLAA 10	10	4,97	13,42
PKLLAA 125	12,5	5,40	14,58

GOLD/ CHROMED POLISHED ALUMINIUM thermo packed
bar length 2,7 LM - packaging 40 Pcs - 108 LM

Article	H mm	€/LM	€/Pc
PKLLBO 045	4,5	6,88	18,58
PKLLBC 045	4,5	6,88	18,58
PKLLBC 10	10	8,50	22,95
PKLLBC 125	12,5	9,10	24,57

News 2105



COLOURS



PROJOLLY QUART has been designed and conceived in still more squared form, with a quarter of circle shape, in order to offer an alternative to **PROJOLLY SQUARE** and **PROJOLLY** as well. It facilitates the laying process eliminating the fragile ceramic corner tiles. It's used for the external corners of the tiles, in order to terminate the finishing of wall coverings, for platforms, stair steps, bathtubs, etc. It guarantees the impeccable work, ensuring considerable aesthetic effect as well. Thanks to the round finishing it strengthens the tile edge avoiding their chipping and breakages. Required by new European regulations on safety and accident prevention in public and private places. Available in capsules and three-axial joints for internal and external angles, end caps and joints. Chromatic combining with **PROLITEL** panelist in aisi 304/1.4301-V2A glossy, super polished or glazed stainless steel recommended. Besides the **PROFINLIST** and **PROLITEL** aluminium panelists available in many finishing versions.



COLOURS



(for a precise assessment of colours and finishes, see the relative enclosed sheet)

POLISHED STAINLESS STEEL AISI 304/1.4301-V2A with protective film
bar length 2,7 LM - packaging 30 Pcs - 81 LM - 10/10mm

Article	H mm	€/LM	€/Pc
PJQTAC 045	4,5	8,52	23,00
PJQTAC 06	6	9,29	25,08

SUPER POLISH. STAINL. STEEL AISI 304/1.4301-V2A
thermo packed - bar length 2,7 LM - Pack. 30 Pcs - 81 LM
10/10mm

Article	H mm	€/LM	€/Pc
PJQTACML 045	4,5	10,37	28,00
PJQTACML 06	6	11,61	31,35

SATINED STAINLESS STEEL AISI 304/1.4301-V2A with protective film
bar length 2,7 LM - packaging 30 Pcs - 81 LM - 10/10mm

Article	H mm	€/LM	€/Pc
PJQTACS 045	4,5	10,73	28,97
PJQTACS 06	6	11,14	30,08

SUITABLE FOR USE IN CONTACT WITH FOODSTUFFS

PROJOLLY QUART

POLISHED, SUPER POLISHED AND SATINED STAINLESS STEEL AISI 304/1.4301-V2A



EXAMPLES AND INSTRUCTIONS FOR LAYING METHODS

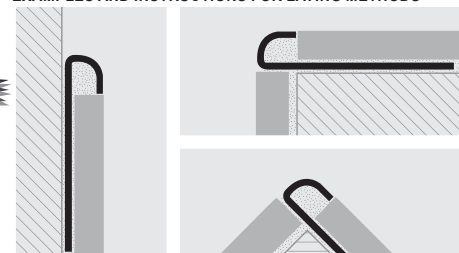

1. Choose the PROJOLLY QUART with suitable height for the thickness of the covering. 2. Apply the adhesive onto the area of application of the profile. 3. Lay and align the profile, cut to the necessary length, pressing the perforated flange into the adhesive. 4. Lay the tiles, aligning them so that the top edge of the profile is flush with the tile. 5. Fill the profile/tile area of contact with adhesive to prevent the accumulation of water in any voids.

profiles for low thicknesses

CAPSULES, CAPS AND THREE - AXIAL JOINTS

POLISHED, SUPER POLISHED and SATINED STAINLESS STEEL AISI 304/1.4301-V2A / PLASTIC

CAPSULES and CAPS - POLISHED STAINLESS STEEL AISI 304/1.4301-V2A

Article	H mm	€/Pc	€/pack. 10 pcs	€/pack. 2 pcs
CPJQTAC 045/... (outside)	4,5	10,94	109,40	24,13
IPJQTAC 045/... (inside)	4,5	10,94	109,40	24,13
TPJQTAC 045/... (end cap)	4,5	2,26	22,60	4,93

Choose the desired packaging. E.g. CPJQTAC .../10 (pack 10 pcs)
CPJQTAC .../2 (pack 2 pcs)

CAPSULES SUPER POLISHED STAINLESS STEEL AISI 304/1.4301-V2A

Article	H mm	€/Pc	€/pack. 10 pcs	€/pack. 2 pcs
CPJQTACML 045/... (outside)	4,5	12,73	127,30	27,73
IPJQTACML 045/... (inside)	4,5	12,73	127,30	27,73

Choose the desired packaging. E.g. CPJQTACML .../10 (pack 10 pcs)
CPJQTACML .../2 (pack 2 pcs)

CAPSULES and CAPS - SATINED STAINLESS STEEL AISI 304/1.4301-V2A

Article	H mm	€/Pc	€/pack. 10 pcs	€/pack. 2 pcs
CPJQTACS 045/... (outside)	4,5	12,73	127,30	27,73
IPJQTACS 045/... (inside)	4,5	12,73	127,30	27,73
TPJQTACS 045/... (end cap)	4,5	2,26	22,60	4,93

Choose the desired packaging. E.g. CPJQTACS .../10 (pack 10 pcs)
CPJQTACS .../2 (pack 2 pcs)

JOINTS - PLASTIC

Article	H mm	€/Pc	€/pack. 10 pcs	€/pack. 2 pcs
GIJQT 045/...	4,5	2,16	21,60	4,72

Choose the desired packaging: E.g. GIJQT .../10 (pack 10 pcs)
GIJQT .../2 (pack 2 pcs)

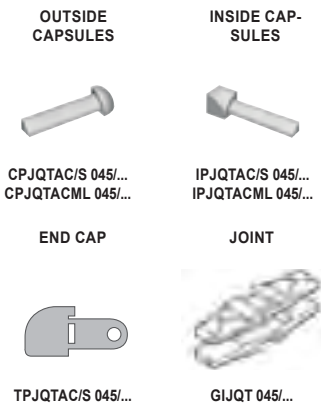

PROJOLLY KERLITE / MOSAICO is an aluminium profile with various surface finishes studied and designed to facilitate the laying of Kerlite/laminam, mosaic and resins. It is also used as a finishing square for terminating wall coverings, raised platforms, steps, bath tubs, pools etc. It guarantees flawless work done with care that is of great aesthetic value. It strengthens the kerlite / mosaic edge with a round finish by avoiding chipping and breakages. Available in seven finishes: 2 shiny: Polished Chrome and Gold and 2 matt Silver and Gold and 3 shiny brushed Silver, Copper, and Titanium.



POLISHED ALUMINIUM (chromed- gold) thermo packed
bar length 2,7 LM - packaging 40 Pcs - 108 LM

Article	H mm	€/LM	€/Pc
PJBC 03 (poli. chrome)	3	6,18	16,69
PJBO 03 (poli. gold)	3	6,18	16,69
PJBC 045 (poli. chrome)	4,5	6,37	17,20
PJBO 045 (poli. gold)	4,5	6,37	17,20
PJBC 06 (poli. chrome)	6	6,52	17,60
PJBO 06 (poli. gold)	6	6,52	17,60

COLOURS

(for a precise assessment of colours and finishes, see the relative enclosed sheet)



ANODISED ALUMINIUM (silver-gold) thermo packed
bar length 2,7 LM - packaging 40 Pcs - 108 LM

Article	H mm	€/LM	€/Pc
PJAA 03 (anod. silver)	3	3,54	9,56
PJAO 03 (anod. gold)	3	3,54	9,56
PJAA 045 (anod. silver)	4,5	3,75	10,13
PJAO 045 (anod. gold)	4,5	3,75	10,13
PJAA 06 (anod. silver)	6	4,01	10,83
PJAO 06 (anod. gold)	6	4,01	10,83

BRUSHED POLISHED ALUM. (silver-copper-titanium) thermo packed
bar length 2,7 LM - packaging 40 Pcs - 108 LM

Article	H mm	€/LM	€/Pc
PJBS 03 (brushed silver)	3	7,29	19,68
PJRS 03 (brushed copper)	3	7,29	19,68
PJTS 03 (brushed titanium)	3	7,29	19,68
PJBS 045 (brushed silver)	4,5	7,55	20,39
PJRS 045 (brushed copper)	4,5	7,55	20,39
PJTS 045 (brushed titanium)	4,5	7,55	20,39

PROJOLLY

ANODISED, POLISHED AND BRUSHED POLISHED ALUMINIUM

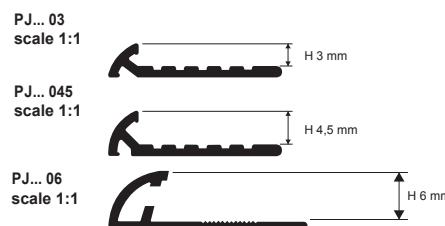

EXAMPLES AND INSTRUCTIONS FOR LAYING METHODS

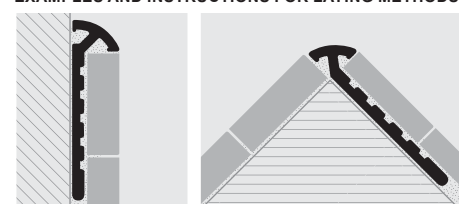

1. Choose the surface finish of the PROJOLLY KERLITE/MOSAICO and PROTERMINAL whose height corresponds to the thickness of the covering. 2. Apply the adhesive in the area that the square is being applied. 3. Rest and line up the square, cut to the required length, pressing the perforated tab into the adhesive. 4. Lay the mosaic / Kerlite, or apply the resin, lining it up so that the upper part of the square meets with their edge. 5. Completely fill the contact area between square and covering with adhesive/resin to prevent the accumulation of water in the empty spaces. IMPORTANT: Take care of the external edges of the aluminium Projolly Mosaico. They must be protected from aggressive substances such as adhesives and sealants and from smoothing or scraping action.

profiles for low thicknesses

PROTERMINAL

POLISHED AND SATINED
STAINLESS STEEL AISI 304/1.4301-V2A

PROTERMINAL KERLITE / MOSAIC is a steel square. It completes the laying of the external angles and terminating coverings/floors in kerlite/laminam or mosaic by protecting external corners efficiently, avoiding chipping and breakages resulting from knocks and acts as a container connector for the resins. **PROTERMINAL KERLITE / MOSAIC** is also used as a finishing square for finishing skirting, carpet and epoxy resin coverings or for baths and kitchens coverings. It strengthens the kerlite / mosaic edge.

profiles for low thicknesses

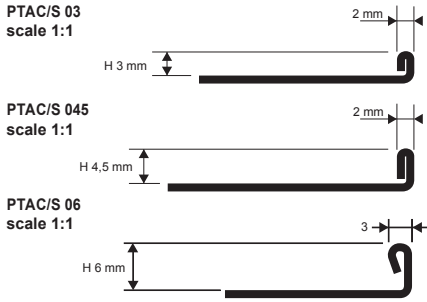

EXEMPLES OF LAYING

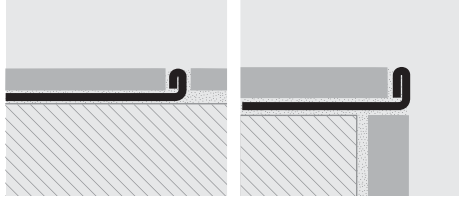

LAYING INSTRUCTIONS

1. Choose the PROTERMINAL with the same height as the thickness of the covering. 2. Apply the adhesive onto the area of application of the profile. 3. Lay and align the profile pressing the perforated flange into the adhesive. 4. Lay the tiles, aligning them so that the top edge of the profile is flush with the tile. 5. Use the adhesive to seal any empty interstices.



POLISHED STAINLESS STEEL AISI 304/1.4301-V2A with protective film
bar length 2,7 LM - packaging 40 Pcs - 108 LM - 10/10mm

Article	H mm	€/LM	€/Pc
PTAC 03	3	7,19	19,41
PTAC 045	4,5	7,34	19,82
PTAC 06	6	7,65	20,66

SATINED STAINLESS STEEL AISI 304/1.4301-V2A with protective film
bar length 2,7 LM - packaging 40 Pcs - 108 LM - 10/10mm

Article	H mm	€/LM	€/Pc
PTACS 03	3	8,37	22,60
PTACS 045	4,5	9,14	24,68
PTACS 06	6	9,45	25,52

SUITABLE FOR USE IN CONTACT WITH FOODSTUFFS.

PROTERMINAL

NATURAL, ANODISED, POLISHED AND
BRUSHED POLISHED ALUMINIUM

PROTERMINAL KERLITE / MOSAICO is an aluminium square with various superficial finishes. It completes the laying of the external angles and terminating coverings/floors in Kerlite/laminam, mosaic and/or resins by protecting external corners efficiently, avoiding chipping and breakages resulting from knocks and acts as a container connector for the resins. **PROTERMINAL KERLITE / MOSAICO** is also used as a finishing square for finishing skirting, carpet and epoxy resin coverings or for baths and kitchens coverings. It reinforces the mosaic / resin edge. Available in eight finishes: 1 natural. 2 shiny: Polished Chrome and Gold; and 2 matt: Silver and Gold and 3 shiny brushed: Silver, Copper, and Titanium.

profiles for low thicknesses

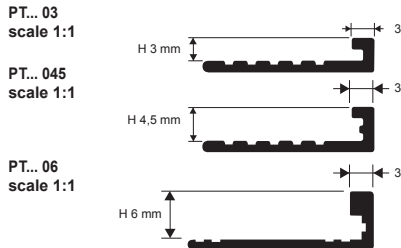

EXEMPLES OF LAYING (for laying instructions, see PROJOLLY)

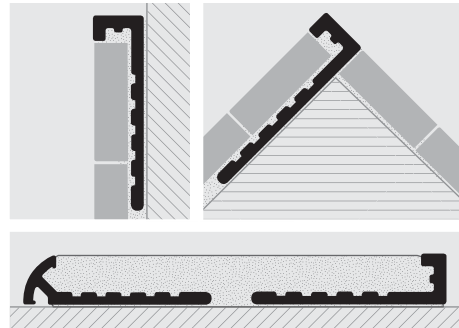

NATURAL ALUMINIUM

bar length 2,7 LM - packaging 40 Pcs - 108 LM

Article	H mm	€/LM	€/Pc
PTAN 03 (natural)	3	2,46	6,64
PTAN 045 (natural)	4,5	2,52	6,80

ANODISED ALUM. (silver-gold) thermo packed

bar length 2,7 LM - packaging 40 Pcs - 108 LM

Article	H mm	€/LM	€/Pc
PTAA 03 (anod. silver)	3	2,98	8,05
PTAO 03 (anod. gold)	3	2,98	8,05
PTAA 045 (anod. silver)	4,5	3,13	8,45
PTAO 045 (anod. gold)	4,5	3,13	8,45
PTAA 06 (anod. silver)	6	3,24	8,75
PTAO 06 (anod. gold)	6	3,24	8,75

POLISHED ALUM. (chromed-gold) thermo packed

bar length 2,7 LM - packaging 40 Pcs - 108 LM

Article	H mm	€/LM	€/Pc
PTBC 03 (poli. chrome)	3	6,15	16,61
PTBO 03 (poli. gold)	3	6,15	16,61
PTBC 045 (poli. chrome)	4,5	6,47	17,47
PTBO 045 (poli. gold)	4,5	6,47	17,47
PTBC 06 (poli. chrome)	6	6,62	17,87
PTBO 06 (poli. gold)	6	6,62	17,87

BRUSHED POLISHED ALUM. (silver-copper-titanium) thermo packed

bar length 2,7 LM - packaging 40 Pcs - 108 LM

Article	H mm	€/LM	€/Pc
PTBS 045 (brushed silver)	4,5	7,86	21,22
PTRS 045 (brushed copper)	4,5	7,86	21,22
PTTS 045 (brushed titanium)	4,5	7,86	21,22

COLOURS

(for a precise assessment of colours and finishes, see the relative enclosed sheet)



PROLISTEL ACC is a range of decorative profiles/strips that are ideal for easily creating chromatic effects on Kerlite / Laminam and mosaic coverings or, in the stainless steel AISI 304/1.4301-V2A range, for creating separations and decorations between floors in the same or differing material. Thanks to their design, shape and thickness of 4.5 mm, may be laid using the same adhesive to create horizontal and vertical lines, on the wall or on the floor, irrespective of the thickness of the covering. Various finishes and widths available in stainless steel AISI 04/1.4301-V2A, polished and satin. Match with the same basic colours in the **PROJOLLY**, **PROTERMINAL** and **PROJOLLY SQUARE** and the new **PROKERLAM SQUARE-LINE-JOLLY** range.

PROLISTEL ACC

POLISHED AND SATINED
STAINLESS STEEL AISI 304/1.4301-V2A



POLISHED STAINLESS STEEL AISI 304/1.4301-V2A with protective film
bar length 2,7 LM - packaging 40 Pcs - 108 LM - 8/10mm

Article	LxH mm	€/LM	€/Pc
PLTAC 1045	10 X 4,5	5,55	14,99
PLTAC 2545	25 X 4,5	12,63	34,10

SATINED STAINLESS STEEL AISI 304/1.4301-V2A with protective film
bar length 2,7 LM - packaging 40 Pcs - 108 LM - 8/10mm

Article	LxH mm	€/LM	€/Pc
PLTACS 1045	10 X 4,5	7,09	19,14
PLTACS 2545	25 X 4,5	14,58	39,37

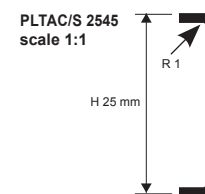
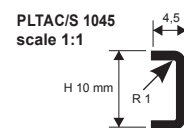

profiles for low thicknesses

EXAMPLES AND INSTRUCTIONS FOR LAYING METHODS

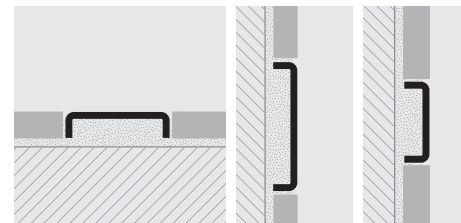

1. Choose the PROLISTEL ACC of the desired length.
2. Apply the adhesive in the area that the square is being applied.
3. Rest and line up the square, cut to the required length, pressing it into the adhesive.
4. Lay the tiles lining them up so that the upper part of the square meets with their edge.
5. Fill the contact area between square and tile completely with adhesive to prevent the accumulation of water in the empty spaces. Take care of the external edges of the PROLISTEL, they must be protected from aggressive substances such as adhesives and sealants and from smoothing or scraping action.

COLOURS

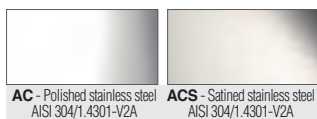

(for a precise assessment of colours and finishes, see the relative enclosed sheet)

SUITABLE FOR USE IN CONTACT WITH FOODSTUFFS.

© 2011 All rights reserved by Progress Profiles. Printed in Italy

PROFINLIST 2045 is a decorative strip that adds colour effects to Kerlite/ Laminam and mosaic tiled walls. It is designed with the perforated base to be laid "under covering" and with the living angles to be combined with rectified coverings. It can also be used to separate floors of the same and/or different kind or to finish the steps. It is applied with the same adhesive for ceramic tiles and/or mosaic. Available in various finishes: Anodised (silver), Polished (chrome-gold), brushed (silver). Combining with the same chromatic base **PROJOLLY**, **PROTERMINAL** and the new **PROKERLAM** and **PROJOLLY SQUARE** range is recommended.

PROFINLIST 2045

ANODISED, POLISHED AND
BRUSHED ALUMINIUM



ANODISED SILVER ALUMINIUM thermo packed
bar length 2,7 LM - packaging 40 Pcs - 108 LM - 8/10mm

Article	H mm	€/LM	€/Pc
PFLTAA 2045	4,5	6,21	16,77

POLISHED GOLD/CHROME ALUMINIUM thermo packed
bar length 2,7 LM - packaging 40 Pcs - 108 LM - 8/10mm

Article	H mm	€/LM	€/Pc
PFLTBC 2045	4,5	7,24	19,55
PFLTBO 2045	4,5	7,24	19,55

POLISHED BRUSHED SILVER ALUMINIUM thermo packed
bar length 2,7 LM - packaging 40 Pcs - 108 LM - 8/10mm

Article	H mm	€/LM	€/Pc
PFLTBS 2045	4,5	8,63	23,30

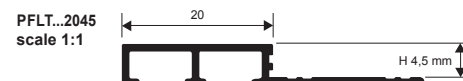

profiles for low thicknesses

EXAMPLES AND INSTRUCTIONS FOR LAYING METHODS

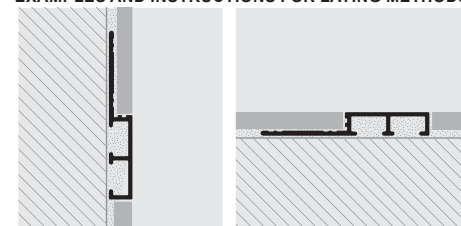

1. Choose the PROFINLIST 2045 surface finish whose height corresponds to covering thickness.
 2. Apply the adhesive in the area that the square is being applied.
 3. Rest and line up the square, cut to the required length, pressing the perforated tab into the adhesive.
 4. Lay the tiles/ ceramic tiles or apply the resin, lining it up so that the upper part of the square meets with their edge.
- IMPORTANT:** Take care of the external edges of the aluminium Profinlist. They must be protected from aggressive substances such as adhesives and sealants and from smoothing or scraping action.

COLOURS

(for a precise assessment of colours and finishes, see the relative enclosed sheet)



PROSHELL D ALL

ANODISED POLISHED SILVER, CHROME,
GOLD ALUMINIUM

profiles for low thicknesses

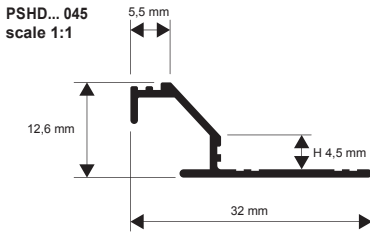

EXAMPLES AND INSTRUCTIONS FOR LAYING METHODS

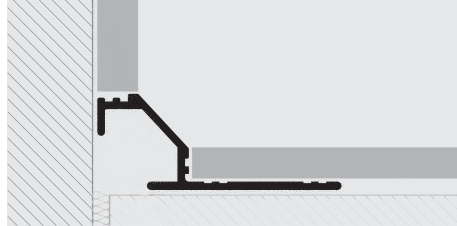

1. Choose the PROSHELL D ALL of the desired surface finish. 2. Apply the adhesive in the area that the square is being applied. 3. Rest and line up the square, cut to the required length, pressing the tab into the adhesive. 4. Lay the Kerlite/ Laminam/ Mosaic tiles lining them up so that the upper part of the square meets with their edge. 5. Fill the contact area between profile and covering completely with adhesive to prevent the accumulation of water in the empty spaces.

IMPORTANT: Take care of the external edges of the aluminium Proshell D All. They must be protected from aggressive substances such as adhesives and sealants and from smoothing or scraping action.

PROSHELL D ALL is an aluminium profile studied and designed to connect with floors and covering in Kerlite / Laminam or mosaic and thin tiles with a chamfered shape. The notching at the two ends of the profile allows for optimal anchoring.

This new profile creates a technical / chromatic effect that is of great aesthetic value. PROSHELL D ALL creates a hygienic connector, is ideal for cleaning, for public and private areas.



ANODISED SILVER ALUMINIUM thermo packed
bar length 2,7 LM - packaging 40 Pcs - 108 LM

Article	H mm	€/LM	€/Pc
PSHDAA 045	4,5	6,37	17,20



POLISHED GOLD/CHROME ALUMINIUM thermo packed
bar length 2,7 LM - packaging 40 Pcs - 108 LM

Article	H mm	€/LM	€/Pc
PSHDBC 045	4,5	8,11	21,90
PSHDBO 045	4,5	8,11	21,90

COLOURS



(for a precise assessment of colours and finishes, see the relative enclosed sheet)

PROSHELL R ALL

ANODISED POLISHED SILVER, CHROME,
GOLD ALUMINIUM

profiles for low thicknesses

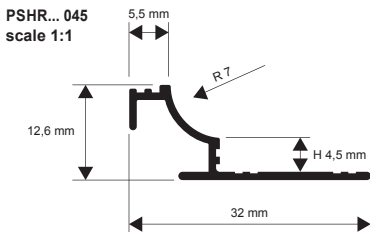

EXAMPLES AND INSTRUCTIONS FOR LAYING METHODS

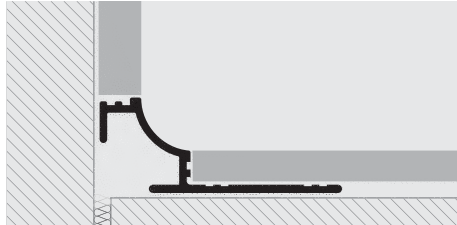

1. Choose the PROSHELL R ALL of the desired surface finish. 2. Apply the adhesive in the area that the square is being applied. 3. Rest and line up the square, cut to the required length, pressing the tab into the adhesive. 4. Lay the Kerlite/ Laminam/ Mosaic tiles lining them up so that the upper part of the square meets with their edge. 5. Fill the contact area between profile and covering completely with adhesive to prevent the accumulation of water in the empty spaces.

IMPORTANT: Take care of the external edges of the aluminium Proshell R All. They must be protected from aggressive substances such as adhesives and sealants and from smoothing or scraping action.

PROSHELL R ALL is an aluminium profile studied and designed to connect with floors and covering in Kerlite / Laminam or mosaic and thin tiles with a rounded shape. The notching at the two ends of the profile allows for optimal anchoring. This new profile creates a technical / chromatic effect that is of great aesthetic value. PROSHELL R ALL creates a hygienic connector, is ideal for cleaning, for public and private areas.

ANODISED SILVER ALUMINIUM thermo packed
bar length 2,7 LM - packaging 40 Pcs - 108 LM

Article	H mm	€/LM	€/Pc
PSHRAA 045	4,5	6,37	17,20

POLISHED GOLD/CHROME ALUMINIUM thermo packed
bar length 2,7 LM - packaging 40 Pcs - 108 LM

Article	H mm	€/LM	€/Pc
PSHRBC 045	4,5	8,11	21,90
PSHRBO 045	4,5	8,11	21,90

COLOURS



(for a precise assessment of colours and finishes, see the relative enclosed sheet)



PRINTER KL ALL is an aluminium and brass profile designed and studied to connect rounded shape internal corners without a punched/perforated base but for insertion: floors and coverings in Kerlite / Laminam or mosaic and thin ceramic tiles. The vertical stem with the arrowhead at its extremity allows for optimal profile anchoring using silicone/glue/bostik. This new profile creates a technical / chromatic / decorative effect that is of great aesthetic value.

PRINTER KL ALL

POLISHED AND CHROMED BRASS
ANODISED AND POLISHED ALUMINIUM



POLISHED / CHROMED BRASS thermo packed
bar length 2,7 LM - Pack. 40 Pcs - 108 LM

Article	H mm	€/LM	€/Pc
PIKL0L 045 (polished)	4,5	11,14	30,08
PIKL0C 045 (chromed)	4,5	17,41	47,01



POLISHED CHROME / GOLD ALUMINIUM thermo packed
bar length 2,7 LM - Pack. 40 Pcs - 108 LM

Article	H mm	€/LM	€/Pc
PIKLBC 045	4,5	6,47	17,47
PIKLBO 045	4,5	6,47	17,47

ANODISED SILVER ALUMINIUM thermo packed
bar length 2,7 LM - Pack. 40 Pcs - 108 LM

Article	H mm	€/LM	€/Pc
PIKLAA 045	4,5	4,52	12,20

PIKL... 045
scale 1:1

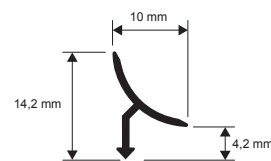

EXAMPLES AND INSTRUCTIONS FOR LAYING METHODS

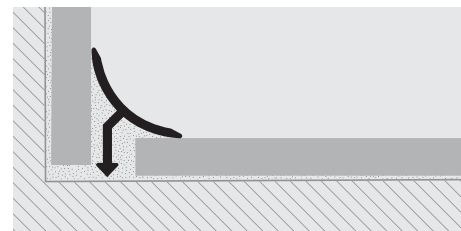

1. Choose the PRINTER KL of the desired surface finish and cut to necessary length. 2. Completely fill the empty space between the two coverings or between floor & covering area with silicone/glue/bostik/adhesive. 3. Insert the profile with the vertical arrowhead stem immersed in the silicone/ glue/ Two-sided tape. **IMPORTANT:** Take care of the external edges of the aluminium Printer KL All. They must be protected from aggressive substances such as adhesives and sealants and from smoothing or scraping action.

profiles for low thicknesses

COLOURS

(for a precise assessment of colours and finishes, see the relative enclosed sheet)



CAPS - Pack. 10 Pcs - Pack. 2 Pcs

Article	€/ 2 Pcs	€/ 10 Pcs
TPSB 15-01	2,50	25,00

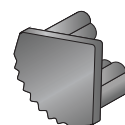

News 2015 available from February

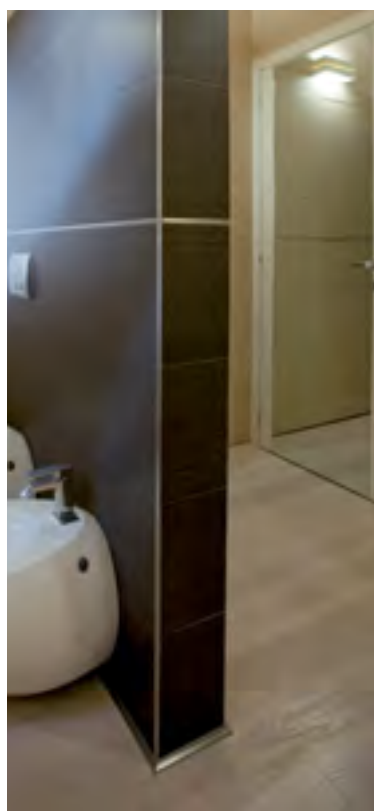
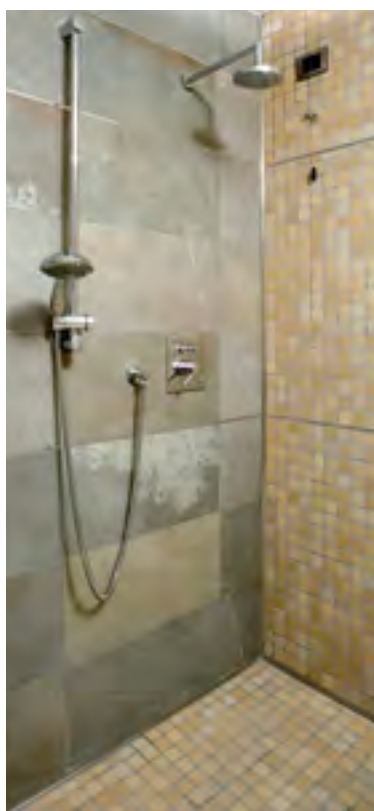

PROTOP

ANODISED AND POLISHED ALUMINIUM

PROTOP is a profile for kitchen countertops, worktops and steps, created and designed to protect the full thickness of the kitchen countertop for a total height of 46 mm including covering; it ends with a round jolly profile that protects the covering of H 10 mm or H 12.5 mm high tiles. External and internal angles at 90° and 135° are in course of realization to facilitate the laying. Available in ANODISED SILVER aluminium and polished titanium.

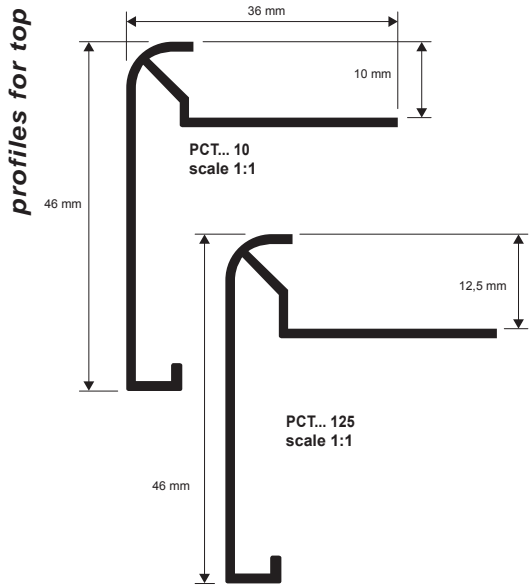

1. Choose the PROTOP with a height suited to the thickness of the covering.
2. Apply sealant to the profile application area.
3. Lay the profile cut to the required length and align it, pressing the perforated flap into the sealant.
4. Lay the tiles, aligning them in such a way that the upper part of the profile closes flush.
5. Fill the contact area between the profile and tile with sealant to prevent water from collecting into the empty spaces.

COLOURS



(for a precise assessment of colours and finishes, see the relative enclosed sheet)

ANODISED SILVER ALUMINIUM

bar length 2,7 LM - Pack. 10 Pcs - 27 LM

Article	H mm	€/LM	€/Pc
PCTAA 10	10	10,37	28,00
PCTAA 125	12,5	10,63	28,70

POLISHED TITANIUM ALUMINIUM

bar length 2,7 LM - Pack. 10 Pcs - 27 LM

Article	H mm	€/LM	€/Pc
PCTBT 10	10	17,30	46,71
PCTBT 125	12,5	17,56	47,41

POLISHED CHROME ALUMINIUM

bar length 2,7 LM - Pack. 10 Pcs - 27 LM

Article	H mm	€/LM	€/Pc
PCTBC 10	10	17,30	46,71
PCTBC 125	12,5	17,56	47,41

INSIDE AND OUTSIDE CORNERS

IN / OUTSIDE CORNER

ANODISED SILVER ALUMINIUM - Pack. 10 Pcs

Article	€/Pc	€/pack
EPCTAA 90 (outside 90°)	15,20	152,00
IPCTAA 90 (inside 90°)	15,20	152,00
EPCTAA 135 (outside 135°)	15,20	152,00
IPCTAA 135 (inside 135°)	15,20	152,00



IN / OUTSIDE CORNER

POLISHED TITANIUM ALUMINIUM - Pack. 10 Pcs

Article	€/Pc	€/pack
EPCTBT 90 (outside 90°)	17,97	179,70
IPCTBT 90 (inside 90°)	17,97	179,70
EPCTBT 135 (outside 135°)	17,97	179,70
IPCTBT 135 (inside 135°)	17,97	179,70

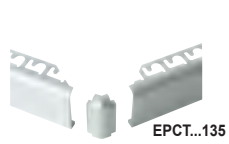

IN / OUTSIDE CORNER

POLISHED CHROME ALUMINIUM - Pack. 10 Pcs

Article	€/Pc	€/pack
EPCTBC 90 (outside 90°)	17,97	179,70
IPCTBC 90 (inside 90°)	17,97	179,70
EPCTBC 135 (outside 135°)	17,97	179,70
IPCTBC 135 (inside 135°)	17,97	179,70



PROTOP T

ANODISED AND POLISHED ALUMINIUM

PROTOP T is a profile in silver anodised aluminium, polished chrome aluminium and polished titanium aluminium, for 10mm and 12,5mm thick coverings, that protects the kitchen countertop edge. The profile consists of a 23,7 mm wide perforated flap, that ensures a perfect grip on the surface, and of a 39 mm high vertical part, with right-angled edge and 3,7 mm wide exposed surface. **PROTOP T**, supplied with special pieces such as inside and outside corners, facilitates perfect laying in any situation.

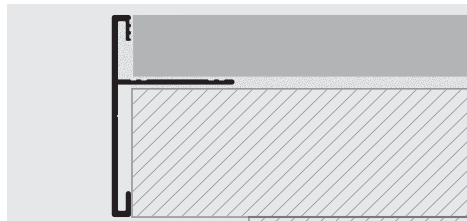
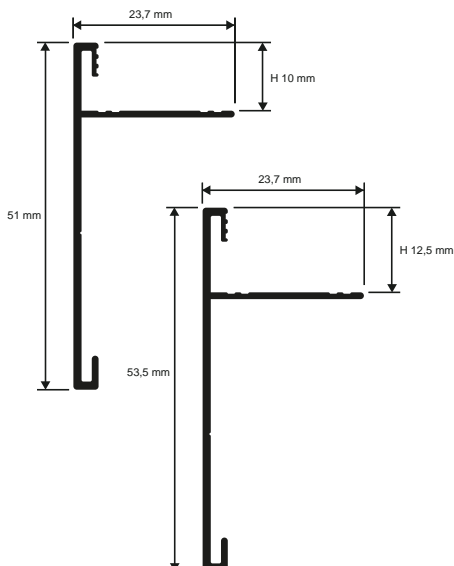

1. Choose PROTOP T depending on the thickness of the tile and on the desired finishing.
2. Cut PROTOP T to the required length and apply sealant on the surface where the profile is to be laid.
3. Press the PROTOP T perforated flap into the sealant.
4. Lay the tiles, aligning them with the profile and leaving a gap of about 2 mm. Immediately remove sealant residues from the surface of the profile.
5. Thoroughly fill the gap between the profile and tile to prevent water stagnation. Immediately remove residual plaster from the surface of the profile.

ANODISED SILVER ALUMINIUM

bar length 2,7 LM - Pack. 10 Pcs - 27 LM

Article	H mm	€/LM	€/Pc
PCTAA 10	10	10,37	28,00
PCTAA 125	12,5	10,63	28,70

COLOURS

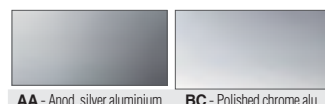

(for a precise assessment of colours and finishes, see the relative enclosed sheet)

POLISHED CHROME ALUMINIUM

bar length 2,7 LM - Pack. 10 Pcs - 27 LM

Article	H mm	€/LM	€/Pc
PCTBC 10	10	17,30	46,71
PCTBC 125	12,5	17,56	47,41

IN / OUTSIDE CORNER

ANODISED SILVER ALUMINIUM - Pack. 10 Pcs

Articolo	€/Pcs	€/conf
IEPCTAA 90T (inside-outside 90°)	15,20	152,00
EPCTAA 135T (outside 90°)	15,20	152,00
IPCTAA 135T (inside 90°)	15,20	152,00

👁 = News 2015 available from March





PROFILES & SYSTEMS